



db

THD International

SURGICAL INSTRUMENTS



info@thdintl.com

www.thdintl.com

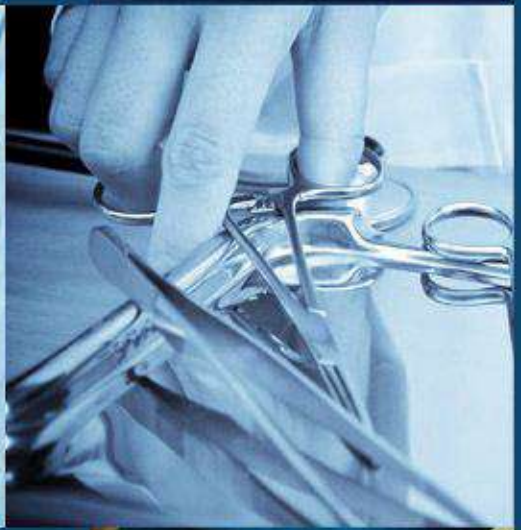

SURGICAL INSTRUMENTS CATALOGUE

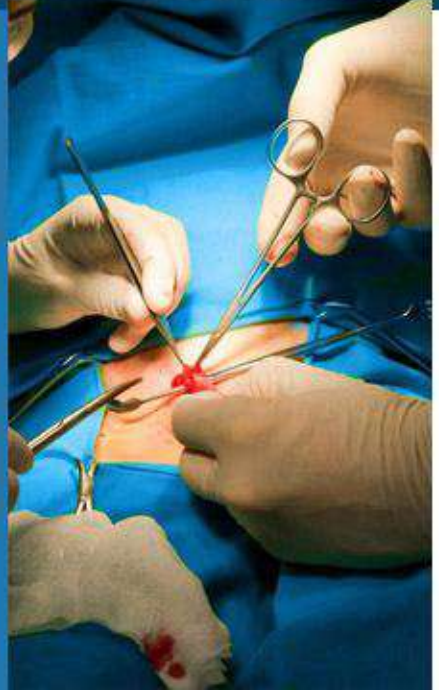

Table Of Contents

















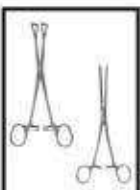
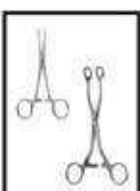
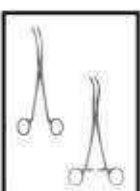
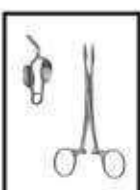

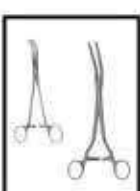

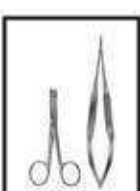
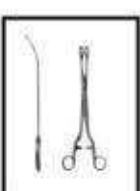
	Page Seite		Page Seite	
Diagnostic, Anaesthesia and other instruments	1 - 10		66 - 68	
Scalpels, knives and Scalpel Handles	11 - 14		69 - 80	
Scissors	15 - 31		81 - 85	
Dissecting-and Tissue Forceps	32 - 42		86 - 93	
Sponge, Dressing and Tissue Grasping Forceps Towel Clamps	43 - 48		94 - 96	
Vessel Clips, Bulldog Clamps Haemostatic Forceps	49 - 57		97 - 100	
Ligature, Hysterectomy and Compression Forceps Vaginal Clamps	58 - 60		101 - 106	
Needle Holders, Suture Instruments	61 - 65		107 - 109	

Table Of Contents

	Page Seite		Page Seite		
Biopsy Instruments and Curettes	110 - 116		Suction Instruments	158 - 166	
Obstetrics and Tracheotomy	117 - 119				
Cardiovascular-and Thoracic Surgery	120 - 128				
Bone Punches, Rongeurs	129 - 134				
Elevators, Bone Levers, Raspatories, Bone Files, Bone Curettes	135 - 139				
Mallets, Chisels and Gouges	140 - 141				
Bone Holding Forceps, Bone Rongeurs, Bone Cutting Forceps	142 - 146				
Plaster Instruments	147 - 157				



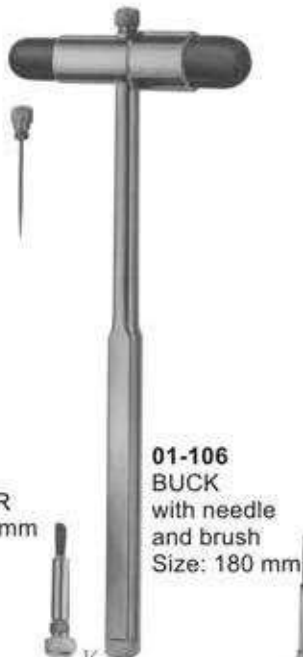

01-110
PINARD (Aluminum)
Size: 155 mm



01-111
wooden
Size: 145 mm



01-112
BOWLES
Stethoscope
with diaphragm



01-113
ANESTOPHON



01-114
FORD-BOWLES
Dual chest piece
with two outlets



01-115
BOWLES



01-116
ZIEGLER Ø 90mm
head mirror only
with rubber coating



01-117
ZIEGLER Ø 90mm
head mirror only
with metal coating



01-118
ZIEGLER
head band of plastic black

01-119
ZIEGLER
head band of plastic white



01-120
MURPHY
head band of celluloid, white



01-121
head band of plastic,
white, soft pattern



01-122
head mirror with black
plastic head band.

Tongue Depressors

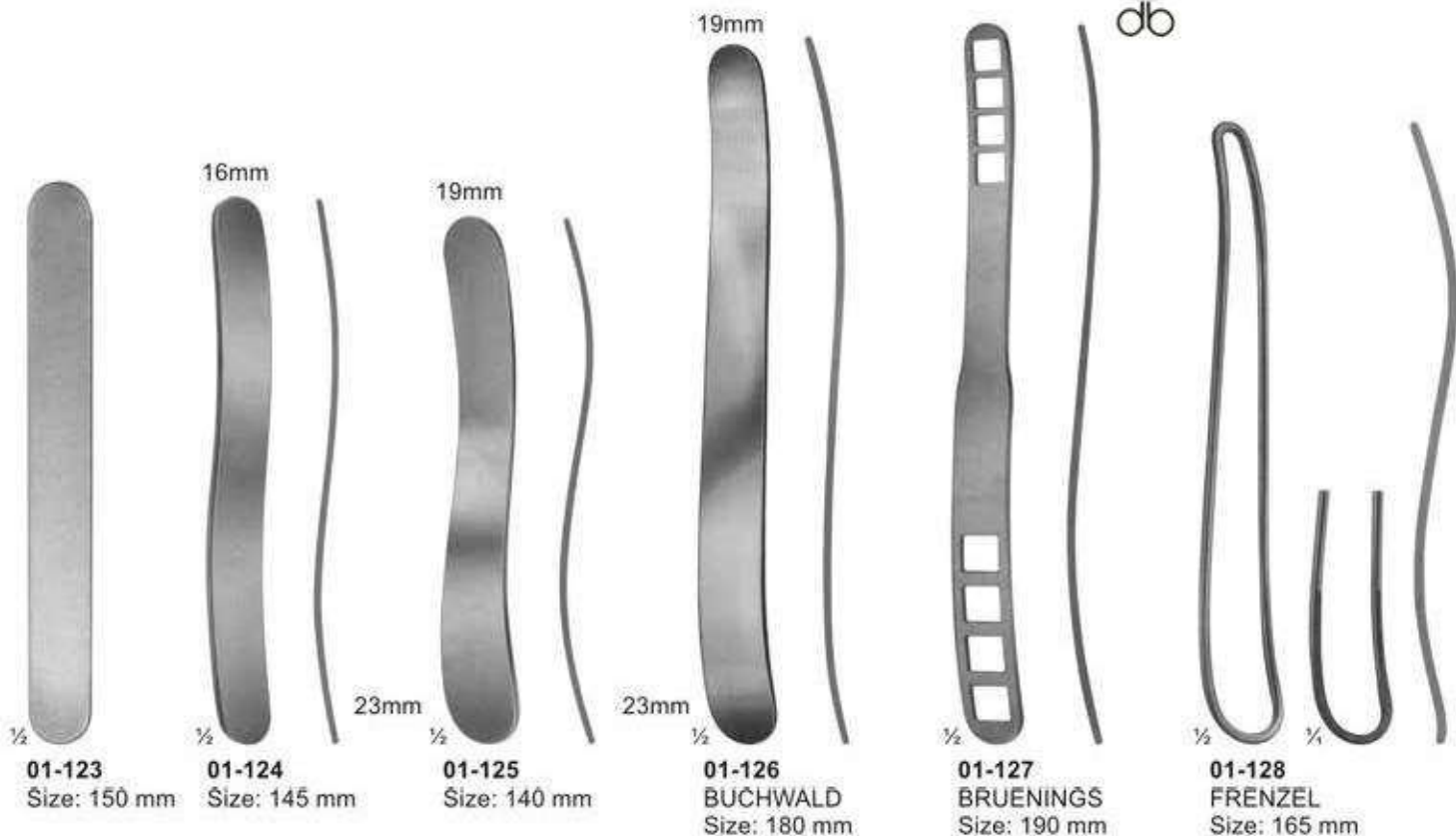



01-134
SCHIMMELBUSCH
Ether mask



01-135
HEISTER
Mouth gag
Size: 130 mm



01-136
FERGUSSON-ACKLAND
Mouth gag
Size: 145 mm



01-137
DENHARDT
Mouth gag with silicon
inserts, interchangeable
Size: 125 mm



01-138
ROSER KOENIG
Mouth gag
Size: 160 mm, 185 mm

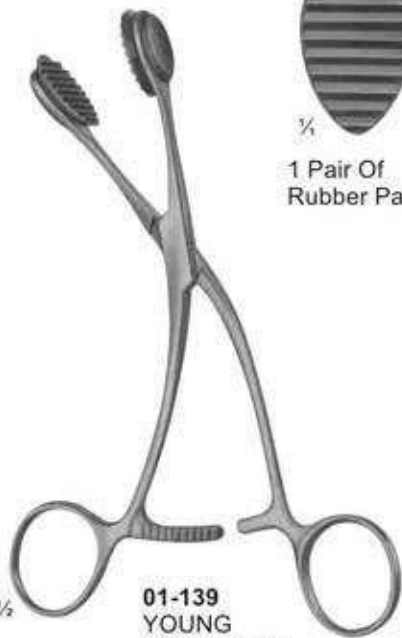

01-139
YOUNG
Size: 165 mm

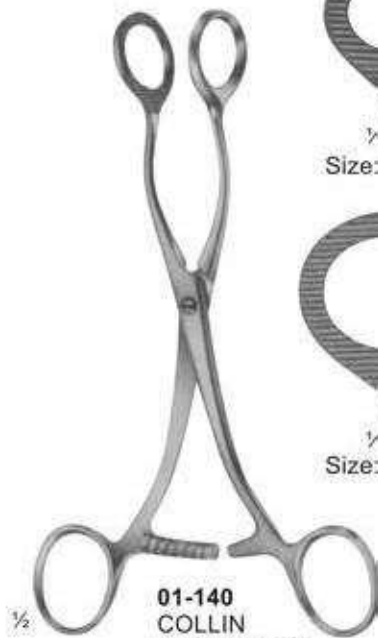

01-140
COLLIN
Size: 160 mm,
170 mm



01-141
HEYWOOD-SMITH
modif. Size: 2

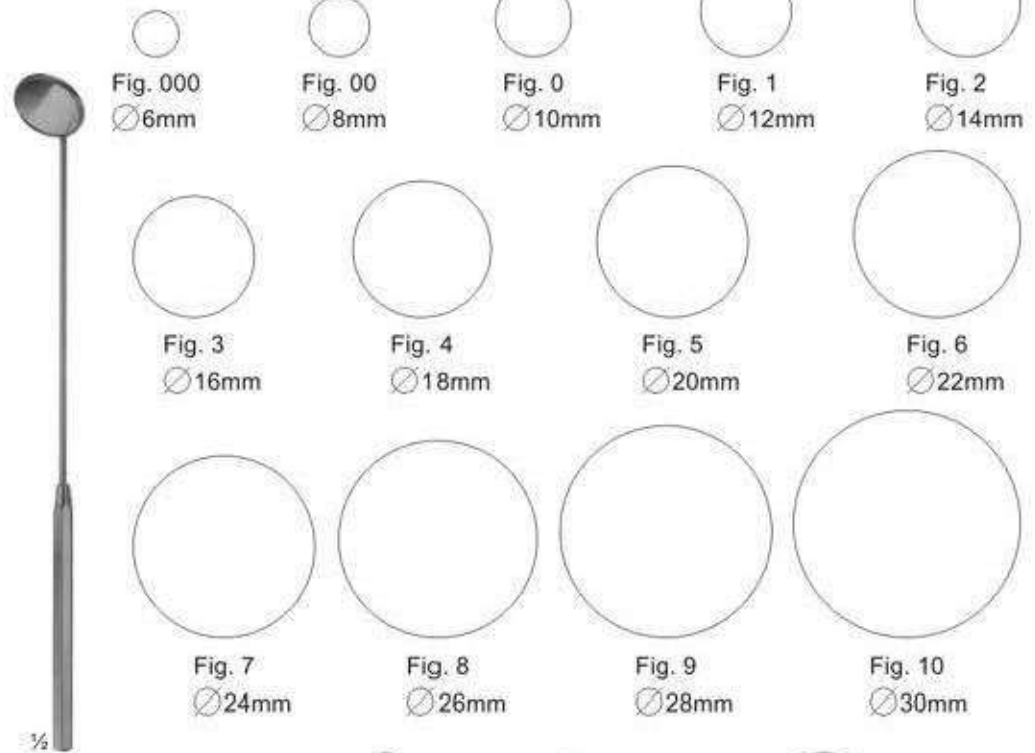

01-143
Laryngeal mirrors with
hexagonal handle
Size: 180 mm

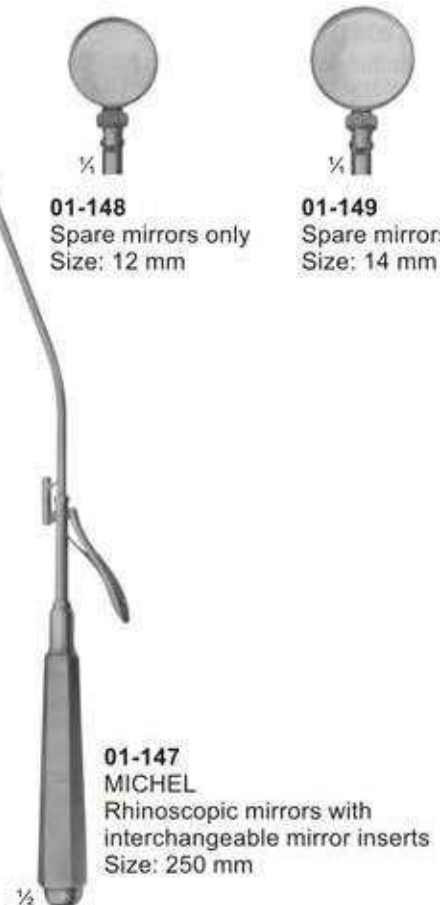
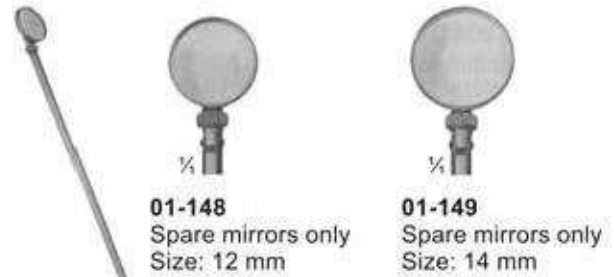

Laryngoscope and Diagnostic Sets



01-150
Infants
Size: 150 mm



01-151
Children
Size: 200 mm



01-152
Adults
Size: 250 mm

01-150 - 152
MAGILL



01-153
Medium battery handle
only, 25 mm diam.



01-153-A
Spare bulb
2.7 volt, for
otoscopes



01-153-B
Spare bulb
2.6 volt, for
ophthalmoscopes



01-154



01-155



01-156
Otoscope set, consists of
battery handle without batteries,
3 ear specula, 1 bulb in velvet lined case



01-157
Diagnostic set, otoscope with three specula,
nasal speculum, lamp holder, two laryn-
mirrors, tongue blade holder



1/2

**01-158
MILLER**
Laryngoscope set, consists of battery handle (without battery)
with four miller laryngoscope blades

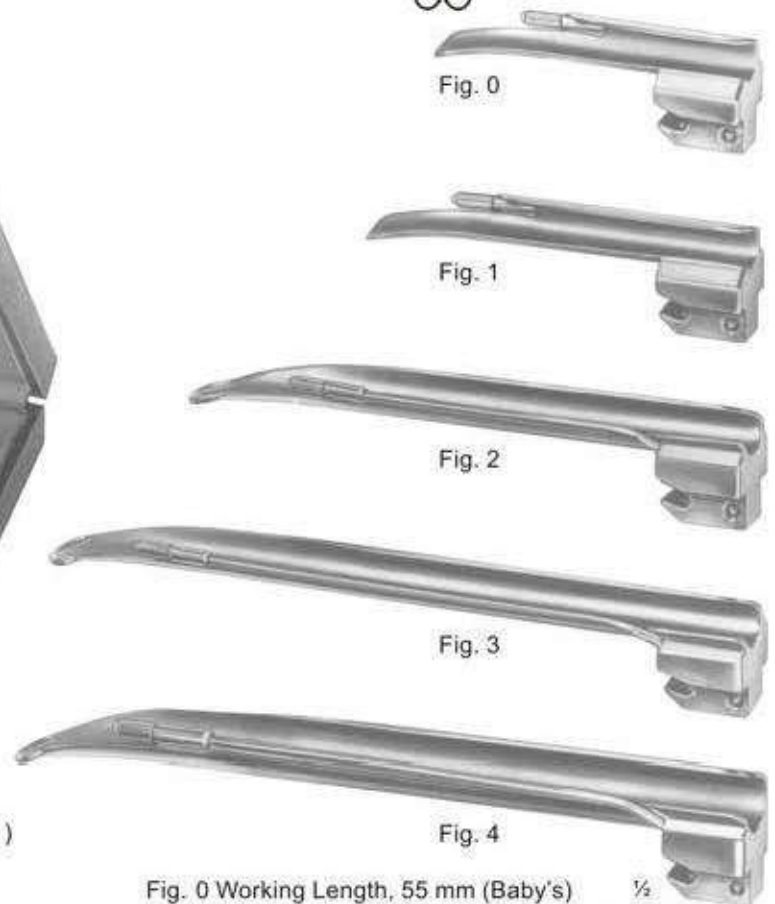

Fig. 0 Working Length, 55 mm (Baby's) 1/2
Fig. 1 Working Length, 80 mm (Children's)
Fig. 2 Working Length, 130 mm (Adolescent's)
Fig. 3 Working Length, 170 mm (Women's)
Fig. 4 Working Length, 180 mm (Men's)



1/2

**01-159
GUEDEL-NEGUS**
Laryngoscope set, consists of battery handle (without battery)
with four miller laryngoscope blades



Fig. 1 Working Length, 70 mm (Children's)
Fig. 2 Working Length, 90 mm (Adolescent's)
Fig. 3 Working Length, 110 mm (Women's)
Fig. 4 Working Length, 135 mm (Men's) 1/2



01-160
McINTOSH
Laryngoscope Set, Consists Of Battery Handle (Without Battery)
With Three McIntosh Blades, Fig. 1, Fig. 2, Fig. 3

01-161
McINTOSH
Laryngoscope Set, Consists Of Battery Handle (Without Battery)
With Five McIntosh Blades, Fig. 0, Fig. 1, Fig. 2, Fig. 3, Fig. 4



01-162
FOREGGER
Laryngoscope Set, Consists Of
Battery Handle (Without Battery)
With Three Foregger Blades,
Fig. 1, Fig. 2, Fig. 3.

01-163
FOREGGER
Laryngoscope Set, Consists Of
Battery Handle (Without Battery)
With Four Foregger Blades,
Fig. 1, Fig. 2, Fig. 3, Fig. 4,



Fig. 0



Fig. 1



Fig. 2

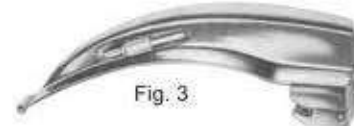

Fig. 3



Fig. 4

01-161 A Fig. 0 Working Length, 55 mm (Baby's)
01-161 B Fig. 1 Working Length, 75 mm (Children's)
01-161 C Fig. 2 Working Length, 90 mm (Adolescent's)
01-161 D Fig. 3 Working Length, 110 mm (Women's)
01-161 E Fig. 4 Working Length, 135 mm (Men's)



Fig. 1



Fig. 2



Fig. 3



Fig. 4

01-162 A Fig. 1 Working Length, 70 mm (Children's)
01-162 B Fig. 2 Working Length, 90 mm (Adolescent's)
01-162 C Fig. 3 Working Length, 110 mm (Women's)
01-162 D Fig. 4 Working Length, 135 mm (Men's)



01-164
Fiber Optic
Battery Handle
30mm diam.



01-165
Fiber Optic
Battery Handle
18mm diam.



01-166
Replacement Lamp
(Krypton) 2.5 V



01-167
Replacement Lamp
(Halogen)

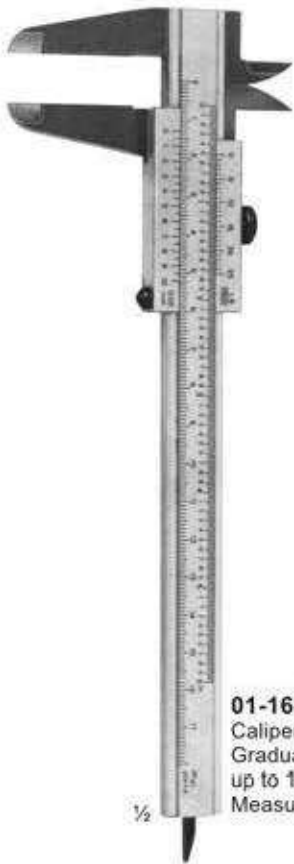

01-168
Caliper Of Aluminium
Graduated in mm & inches
up to 180mm
Measuring Range up to 139mm



01-169
VERNIER
Universal Caliper Of Steel
Graduated in mm & inches
up to 180mm
Measuring Range up to 120mm
with Vernier in 1/10mm & 1/16"



01-170
CARROLL
Size: 145 mm
Finger Goniometer.



01-171
TOWNLEY
Graduated in
mm & inches
Size: 115 mm



01-172
COLLIN
Druck Pressure 72 kg
Size: 125 mm



01-173
BERTILLON
Caliper For Measuring The Head
Size: 320 mm



01-174
CASTROVIEJO
Caliper
Size: 75mm



01-175
MOLTGEN
Goniometer

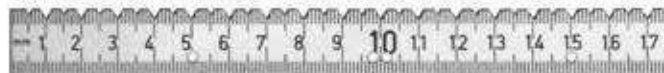

01-176
Size: 150 mm

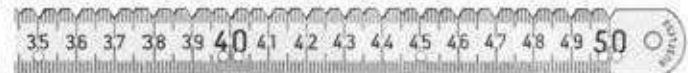

01-177
Size: 500 mm





02-101 - 110
Fig. 1 - 10



02-101
Fig. 1
30 mm



02-102
Fig. 2
36 mm



02-103
Fig. 3
40 mm



02-104
Fig. 4
45 mm



02-105
Fig. 5
50 mm



02-106
Fig. 6
27 mm



02-107
Fig. 7
35 mm



02-108
Fig. 8
40 mm



02-109
Fig. 9
47 mm



02-110
Fig. 10
50 mm



LISTON

02-111
Size: 130 mm
02-112
Size: 160 mm
02-113
Size: 190 mm
02-114
Size: 200 mm

Blade length
Amputating Knives

02-115

CATLIN
Size: 160 mm
Blade length
Amputating
Knives

02-116

LANGENBECK
Size: 120 mm
Blade length
Flap Knives

02-117

Size: 110 mm
Blade length
Interosseous
Knives

02-118

Size: 55 mm
Blade length
with raspatory,
Wooden handle

02-119

Size: 70 mm
Blade length
Wooden handle

02-120

Size: 80 mm
Blade length
Metal handle

02-121

Size: 195 mm
Blade length
Metal handle

Cone Knives, Myomatome, Trigeminal and Tonsil Knives



02-122
 AYRE
 Size: 235 mm
 Cone Knife

02-123
 Size: 230 mm
 Cone Knife

02-124
 SEGOND
 Size: 270 mm
 Myomatome

02-125
 OLIVECRONA
 Size: 205 mm
 Trigeminal
 Knife

02-126
 Size: 230 mm
 Trigeminal
 Knife

02-127
 FOWLER
 Size: 200 mm
 Tonsil Knife

02-128
 ABRAHAM
 Size: 215 mm
 Tonsil Knife

02-129
 BRUNINGS
 Size: 215 mm
 Tonsil Knife



<p>02-130 STANDARD No. 3 Solid 12 cm</p>	<p>02-131 No. 3 Solid 12 cm</p>	<p>02-132 No. 3 Solid 12 cm</p>	<p>02-133 No. 3 L Straight Solid 21.5 cm</p>	<p>02-134 No. 3 L Angled Solid 21 cm</p>	<p>02-135 No. 7 Solid 16 cm</p>	<p>02-136 No. 7 K Solid 12.5 cm</p>	<p>02-137 Hollow-Round 15.5 cm</p>	<p>02-138 No. 3 Straight Solid, Round 14.5 cm</p>	<p>02-139 No. 3 Angled Solid, Round 14 cm</p>
---	--	--	---	---	--	--	---	--	--

Micro Scissors (Spring Type) with Flat Handles

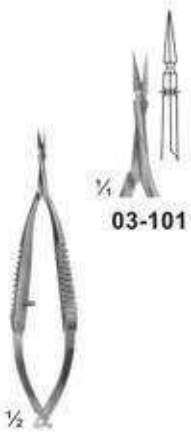

03-101



03-102



03-103

03-101 - 103
VANNAS
Size: 85 mm



03-104



03-105

03-104 - 105
CASTROVIEJO
Size: 95 mm



03-106
NOYES
Size: 125 mm

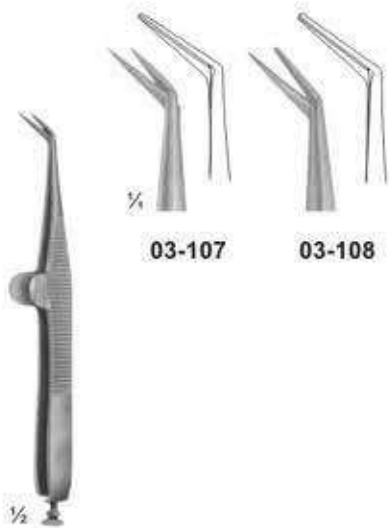

03-107



03-108

03-107 - 108
WECKER
Eye scissor
Size: 110 mm

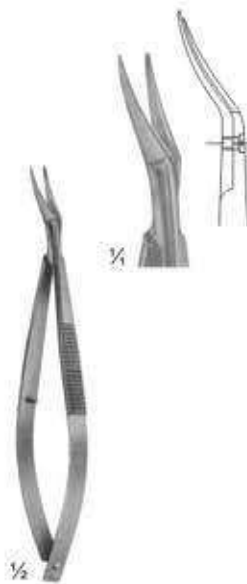

03-109
CASTROVIEJO
Eye scissor
Size: 115 mm

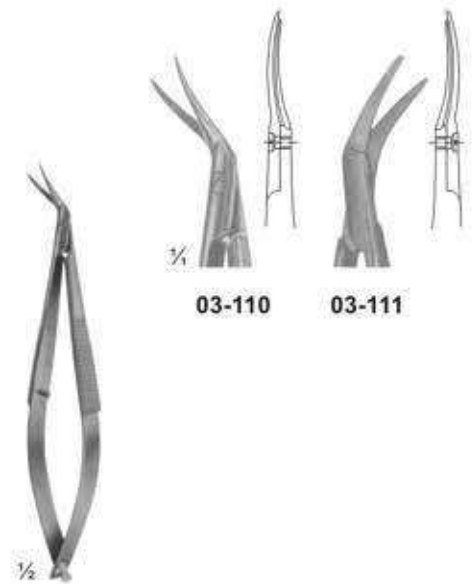

03-110



03-111

03-110 - 111
CASTROVIEJO
Eye scissor
Size: 110 mm

Micro Scissors (Spring Type) with Flat Handles

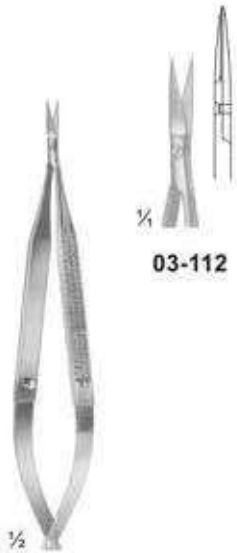

03-112



03-113



03-114
BIEMER
Vein scissor
Size: 130 mm



03-115
Size: 160 mm



03-116 - 117
VANNAS
Size: 160 mm

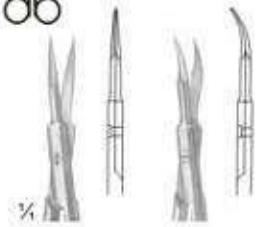

03-116



03-117

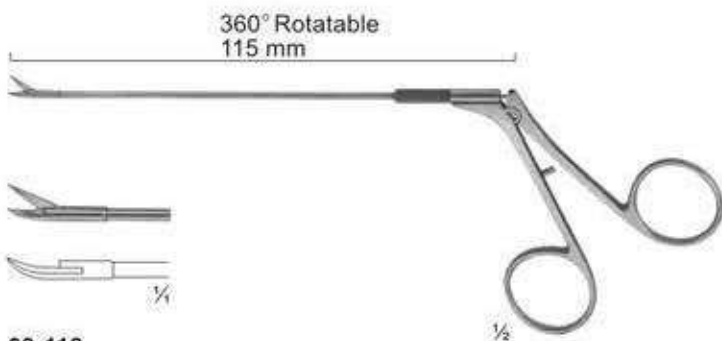

03-118
CASPAR
Micro scissor curved
Size: 115 mm



03-119



03-120



03-121



03-119 - 121
Micro dissecting scissor
Size: 145 mm

Micro Scissors (Spring Type) bayonet-Shaped



$\frac{1}{2}$
03-122
 YASARGIL
 Size: 245 mm



$\frac{1}{2}$
03-123
 45°



$\frac{1}{2}$
03-124
 45°



$\frac{1}{2}$
03-123 - 124
 laterally angled
 Size: 200 mm



$\frac{1}{2}$
125°



$\frac{1}{2}$
03-125
 laterally angled
 Size: 190 mm



$\frac{1}{2}$
03-126



$\frac{1}{2}$
03-127



$\frac{1}{2}$
03-126 - 127
 YASARGIL
 Size: 225 mm

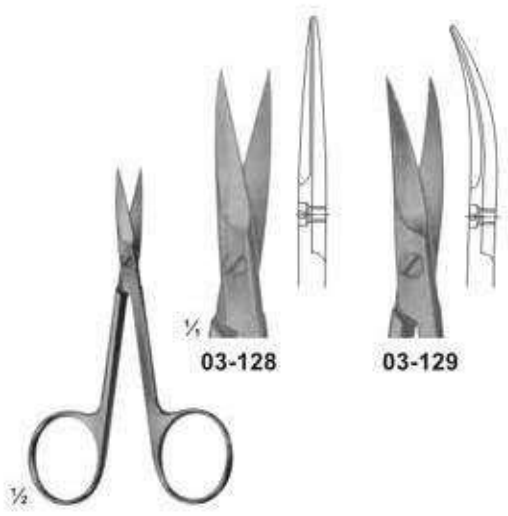

03-128

03-129

03-128 - 129
Size: 90 mm



03-130

03-131

03-130 - 131
Size: 95 mm



03-132

03-133

03-132 - 133
Size: 105 mm

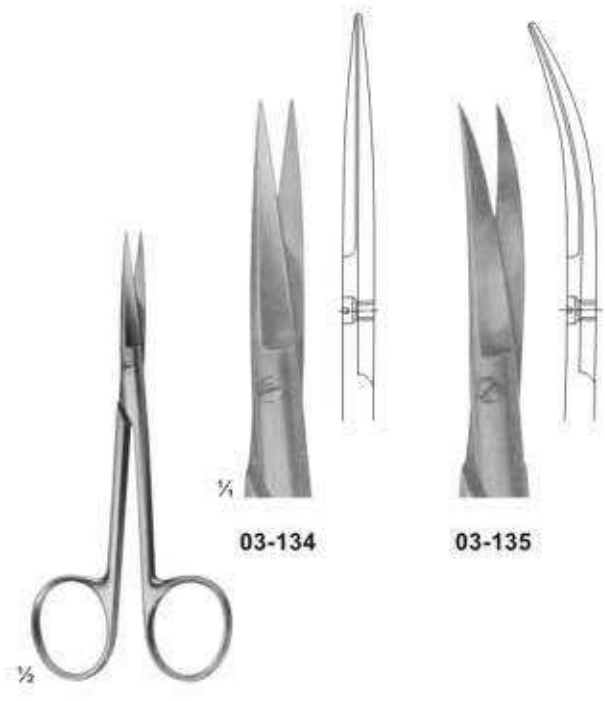

03-134

03-135

03-134 - 135
Size: 120 mm



03-136

03-137

03-136 - 137
Size: 115 mm

Delicate Scissors



03-138 - 140
Size: 120 mm



03-138

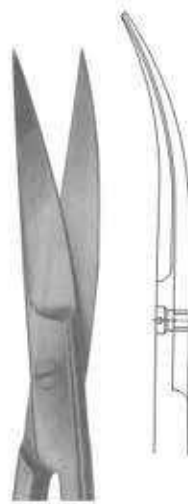

03-139

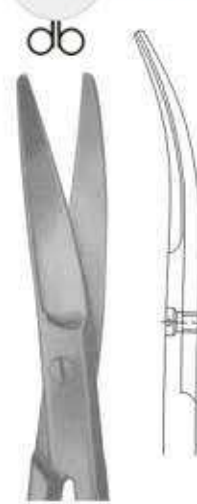

03-140



03-141 - 144
Size: 130 mm

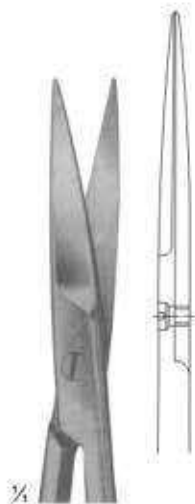

03-141

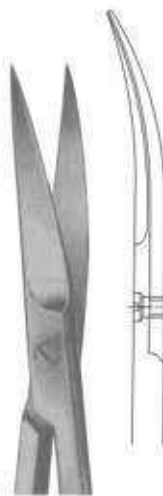

03-142

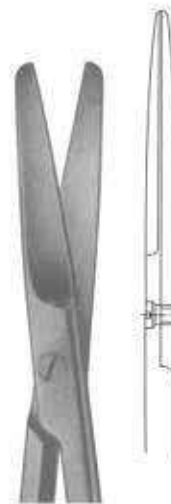

03-143



03-144



03-145 - 153 (Standard types)
 03-145 (105 mm)
 03-146 (115 mm)
 03-147 (130 mm)
 03-148 (145 mm)
 03-149 (150 mm)
 03-150 (165 mm)
 03-151 (175 mm)
 03-152 (185 mm)
 03-153 (200 mm)

03-145
 Size: 105 mm

03-153
 Size: 200 mm

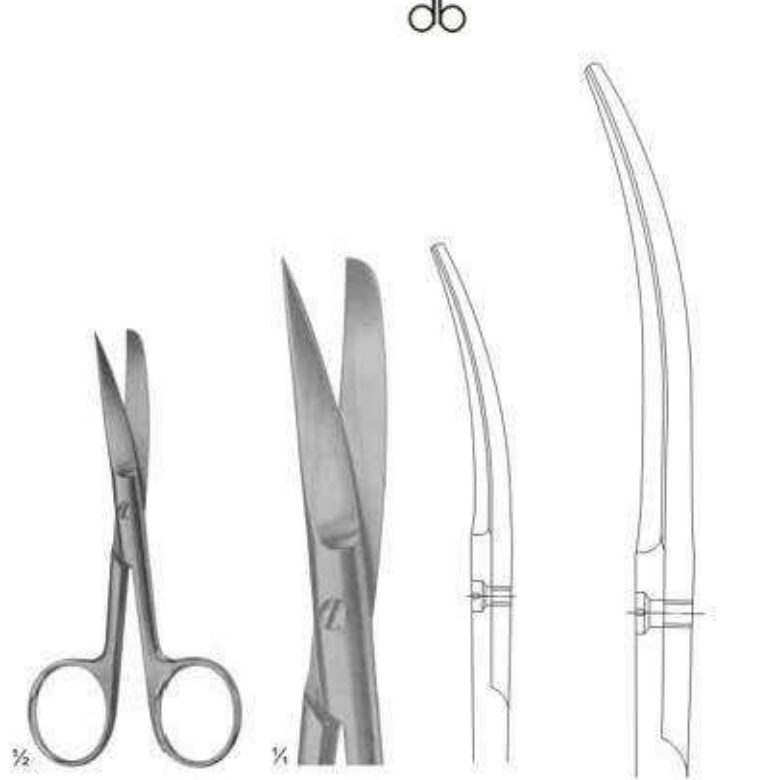

03-154 - 160 (Standard types)
 03-154 (115 mm)
 03-155 (130 mm)
 03-156 (145 mm)
 03-157 (150 mm)
 03-158 (165 mm)
 03-159 (175 mm)
 03-160 (185 mm)

03-154
 Size: 115 mm

03-160
 Size: 185 mm

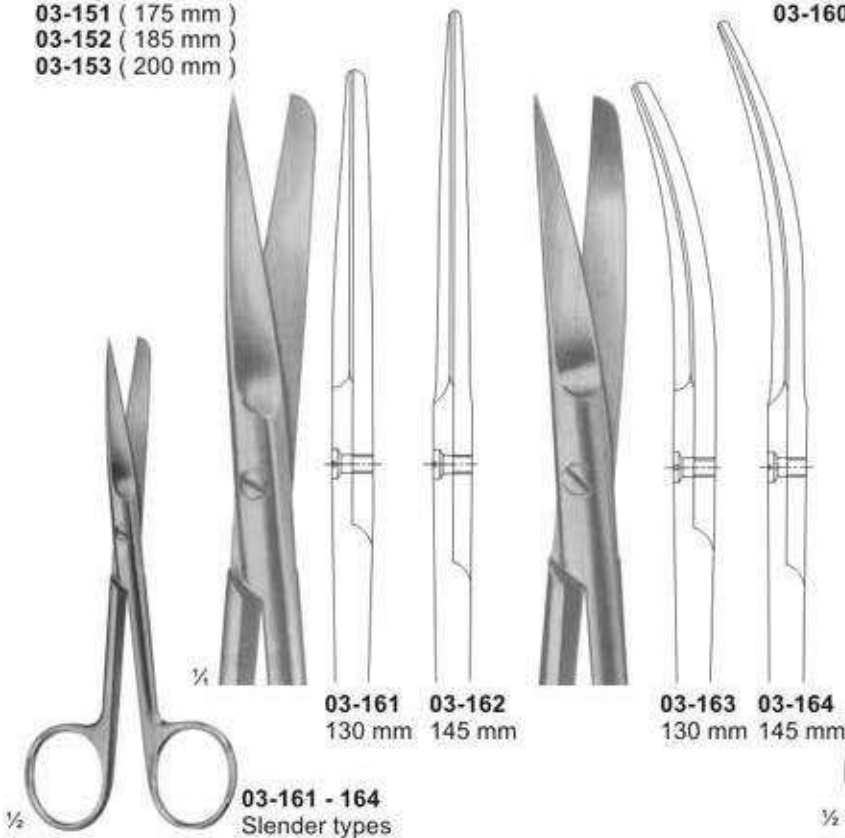

03-161 - 164
 Slender types

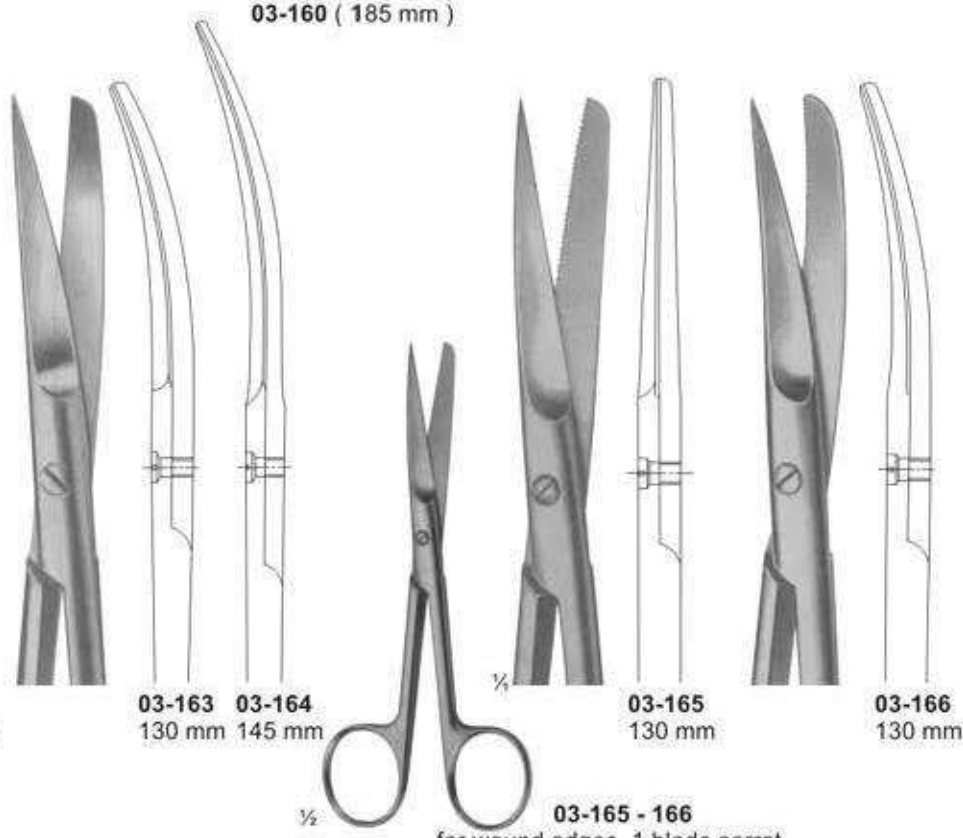

03-165 - 166
 for wound edges. 1 blade serrat



03-167 - 169
DEAVER
with flat lock

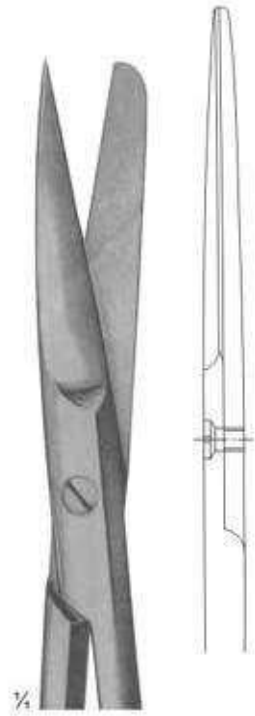

03-167
Size: 145 mm

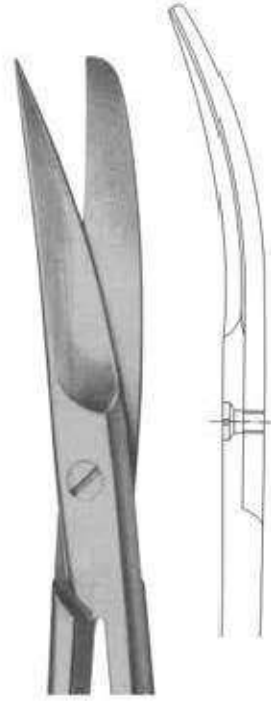

03-168
Size: 145 mm

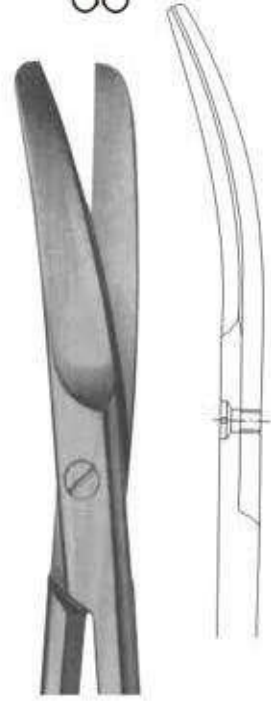

03-169
Size: 145 mm



03-170 - 172
Incision scissors



03-170
Size: 130 mm



03-171
Size: 145 mm



03-172
Size: 165 mm



03-173
SYSTRUNK
Nail splitting scissors



03-173
Size: 130 mm

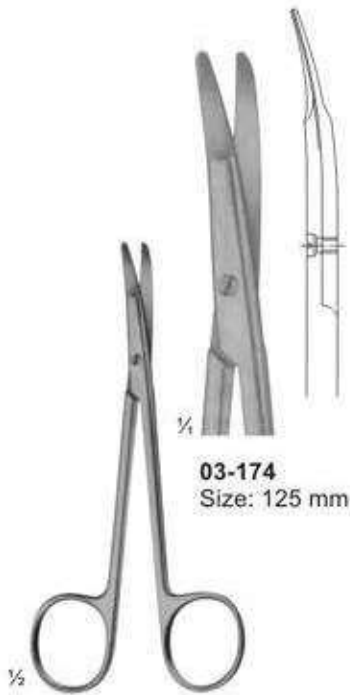

03-174
Size: 125 mm

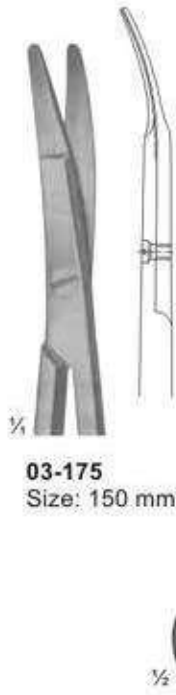

03-175
Size: 150 mm

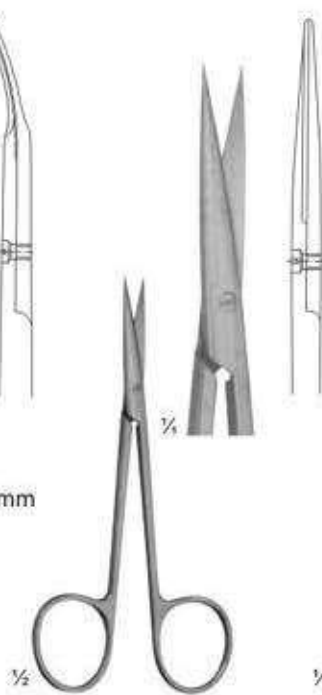

03-176
KILNER
Fine dissecting scissors
Size: 115 mm



03-177
JAMESON
Dissecting scissors
Size: 150 mm

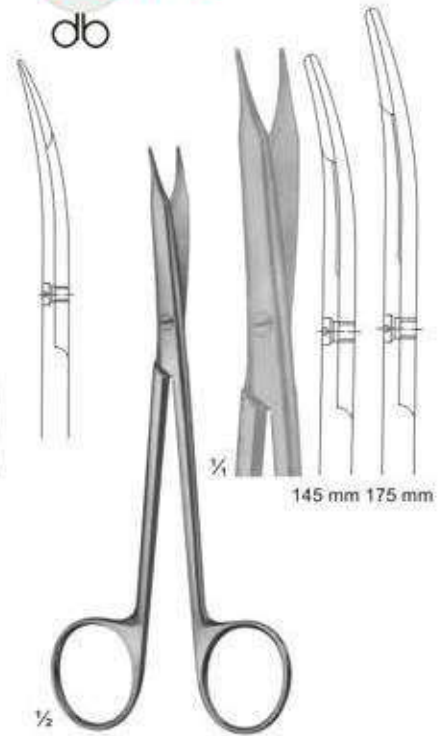

03-178
REYNOLDS
Dissecting scissors
Size: 145 - 175 mm

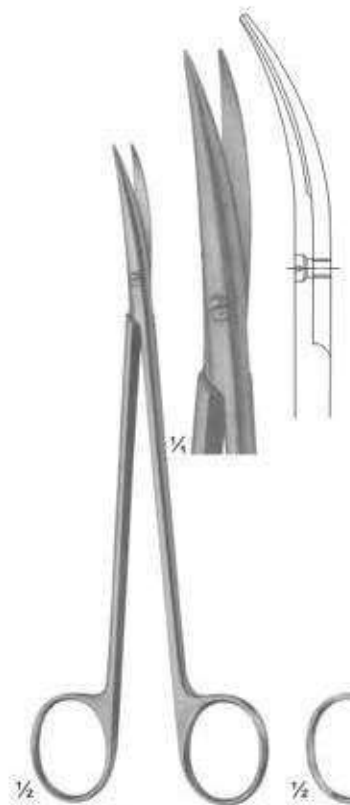

03-179
DE BAKEY
Arteriotomy scissors
Size: 175 mm



03-180 - 181
TOENNIS ADSON
Dissecting scissors
Size: 175 mm

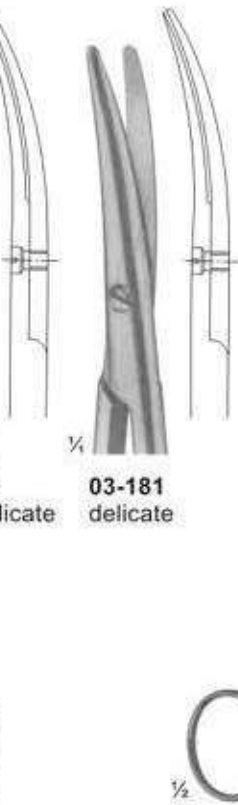

03-181
delicate



03-182
very delicate

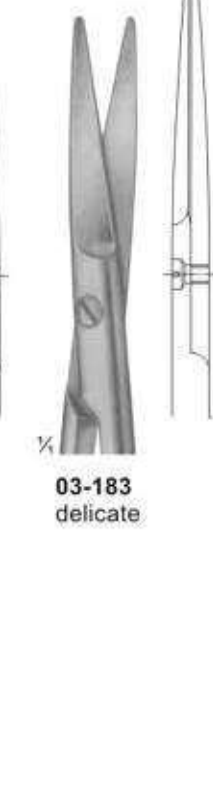

03-183
delicate

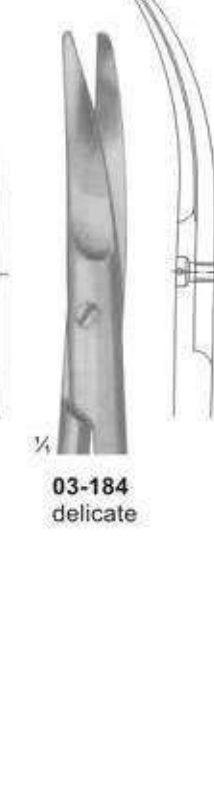

03-184
delicate

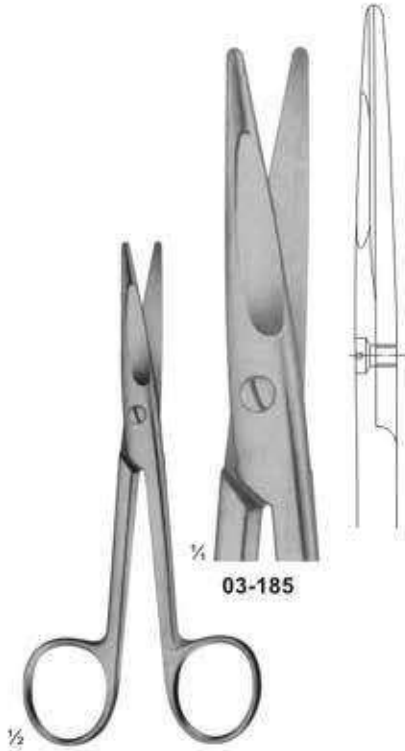

03-185

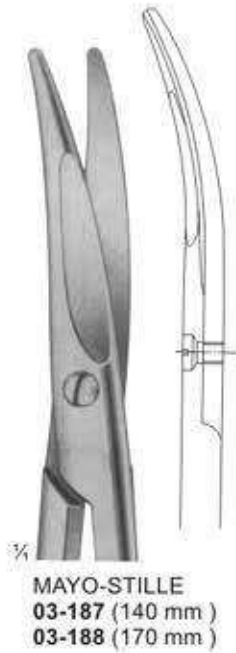

MAYO-STILLE
03-187 (140 mm)
03-188 (170 mm)

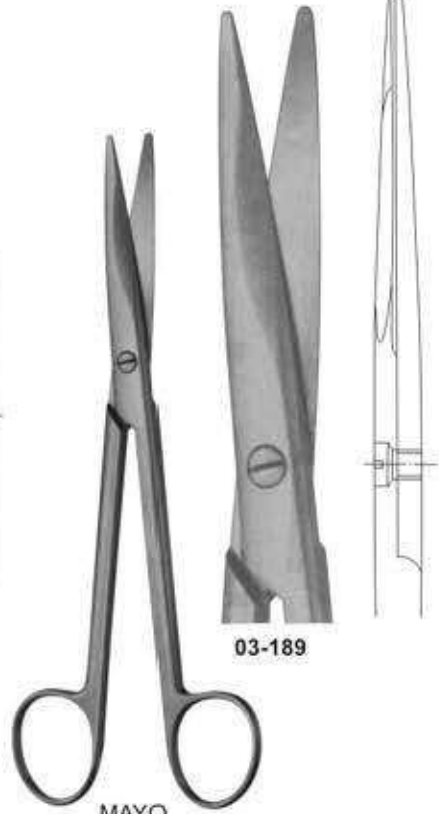

03-189

MAYO
 with chamfered blades.
03-189 (190 mm)
03-190 (215 mm)

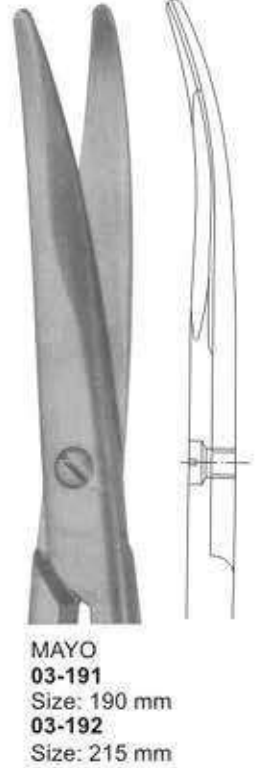

MAYO
03-191
 Size: 190 mm
03-192
 Size: 215 mm

03-185 - 186
MAYO-STILLE
 with chamfered blades
03-185 (140 mm)
03-186 (170 mm)



03-193
 Size: 170 mm

03-193 - 194
MAYO-NOBLE
 broad pattern

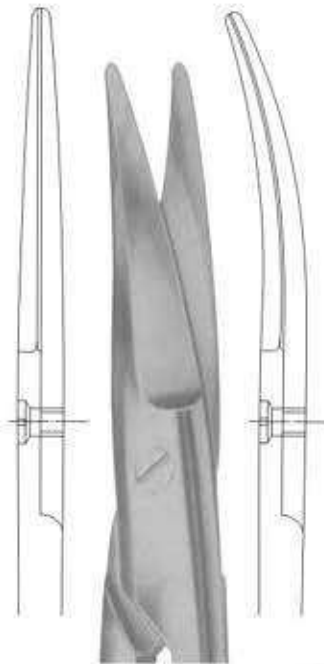

03-194
 Size: 170 mm

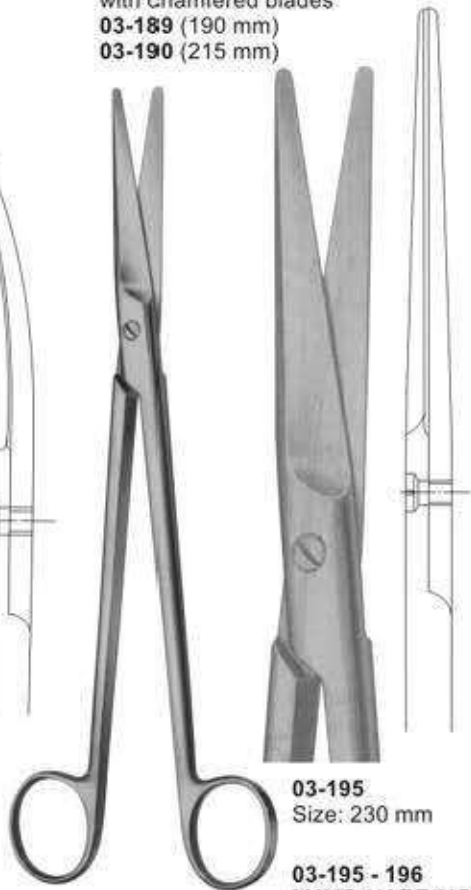

03-195
 Size: 230 mm

03-195 - 196
MAYO-HARRINGTON

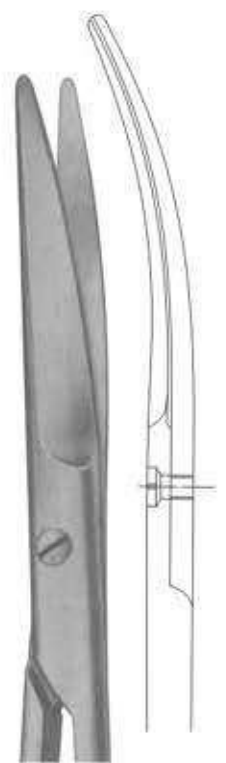

03-196
 Size: 230 mm



03-197
OLIVECRONA
Dura scissors



03-198
STRULLY
pointed
Size: 220 mm

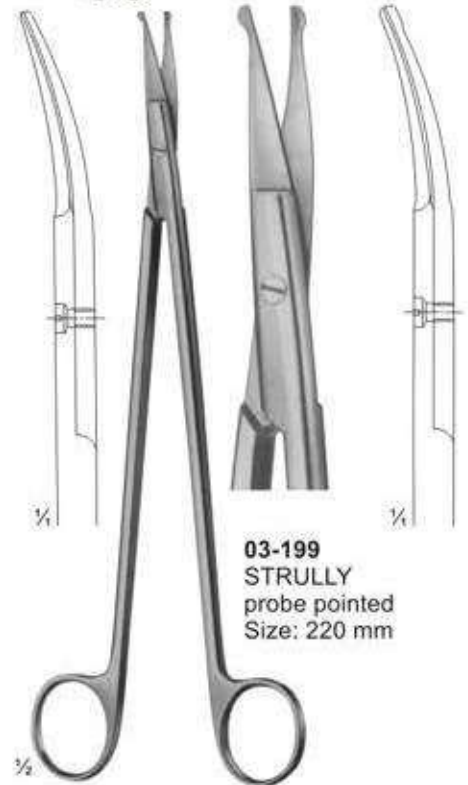

03-199
STRULLY
probe pointed
Size: 220 mm

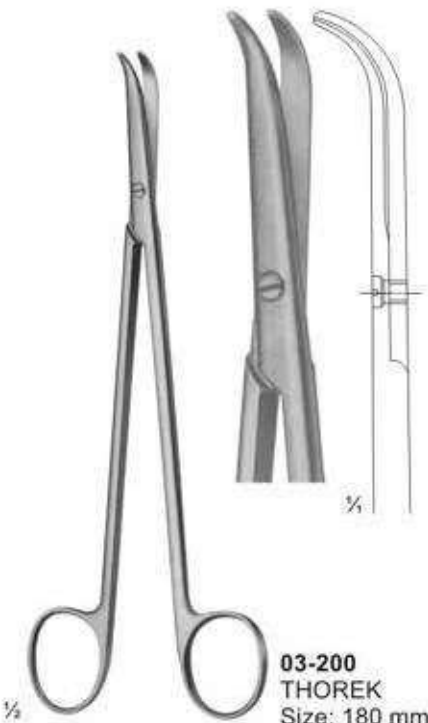

03-200
THOREK
Size: 180 mm

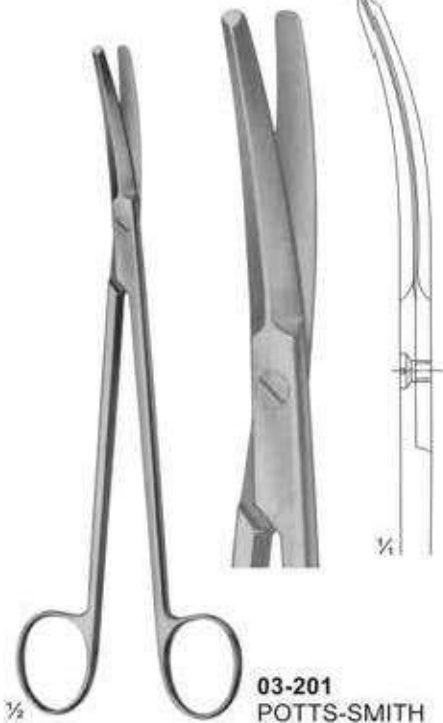

03-201
POTTS-SMITH
Size: 190 mm

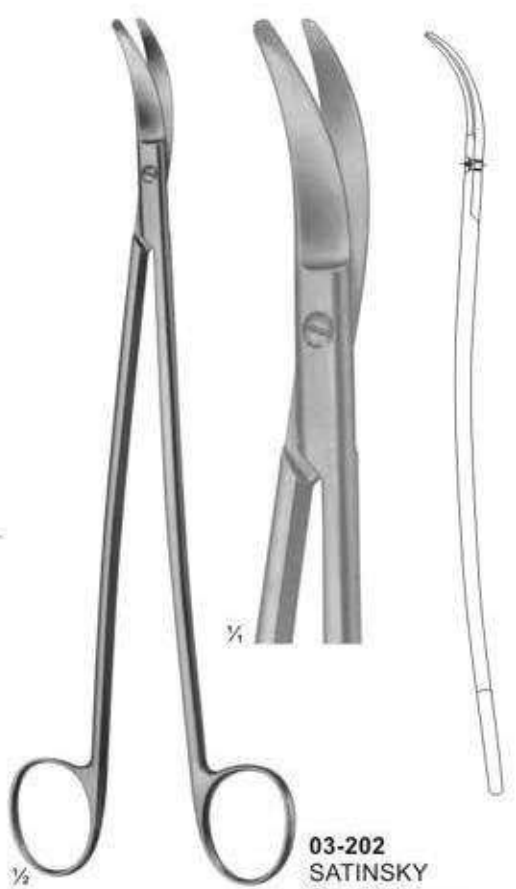

03-202
SATINSKY
Size: 245 mm

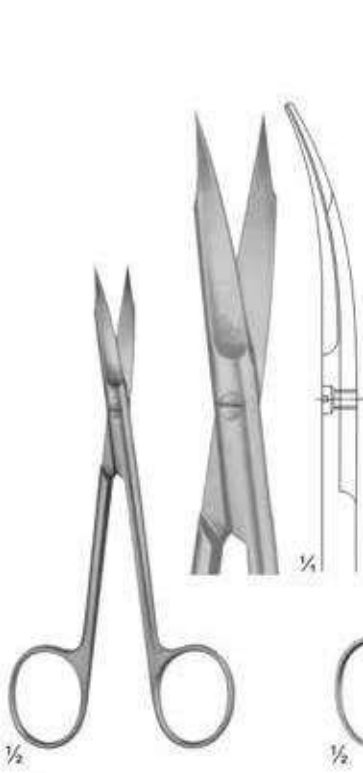

03-203
1 finely toothed blade
Size: 130 mm

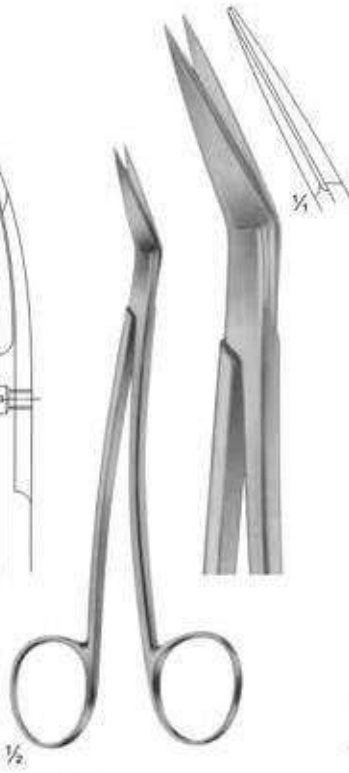

03-204
LOCKLIN
curved sideways,
1 toothed blade
Size: 155 mm



03-205
FOMON
blades serrated
Size: 145 mm

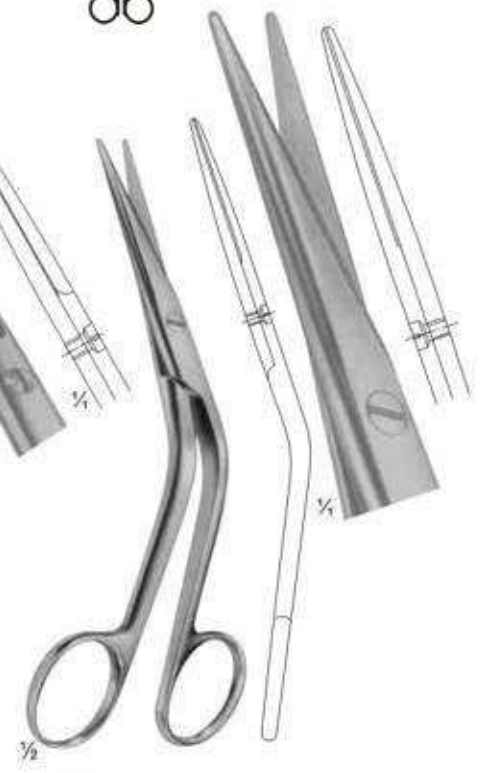

03-206
COTTLE
Size: 165 mm

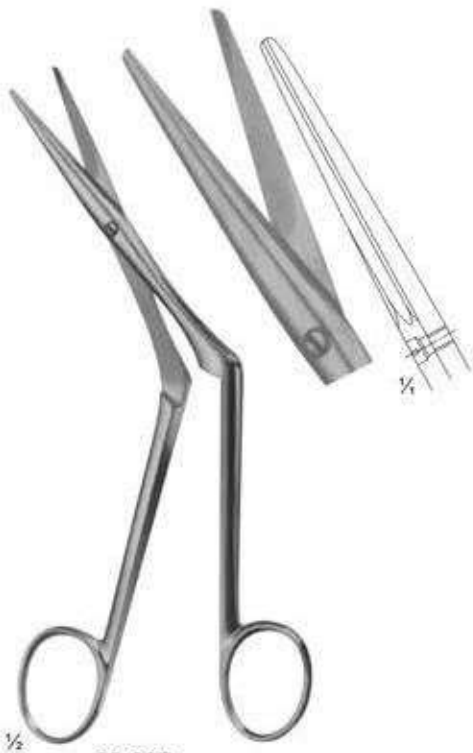

03-207
HEYMAN-KNIGHT
Size: 175 mm

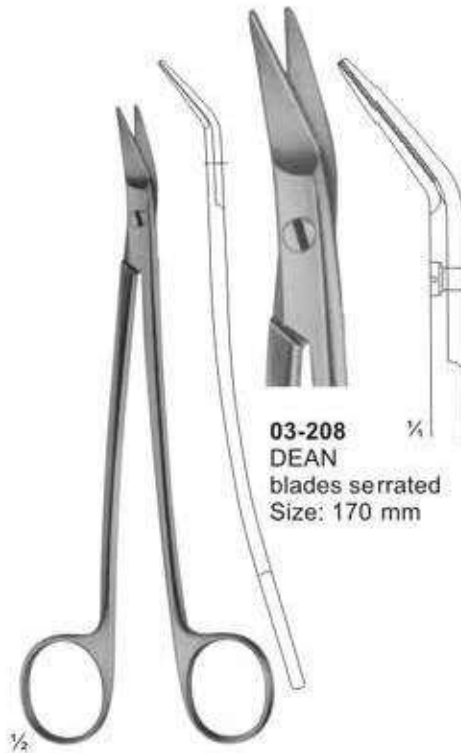

03-208
DEAN
blades serrated
Size: 170 mm

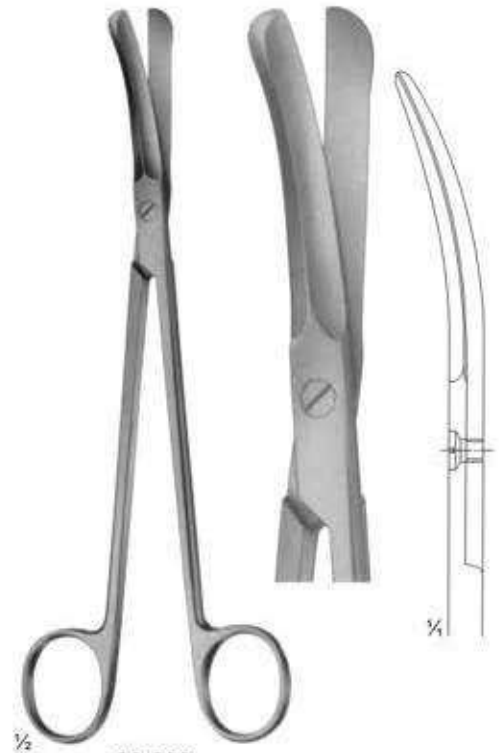

03-209
GOOD
Size: 195 mm

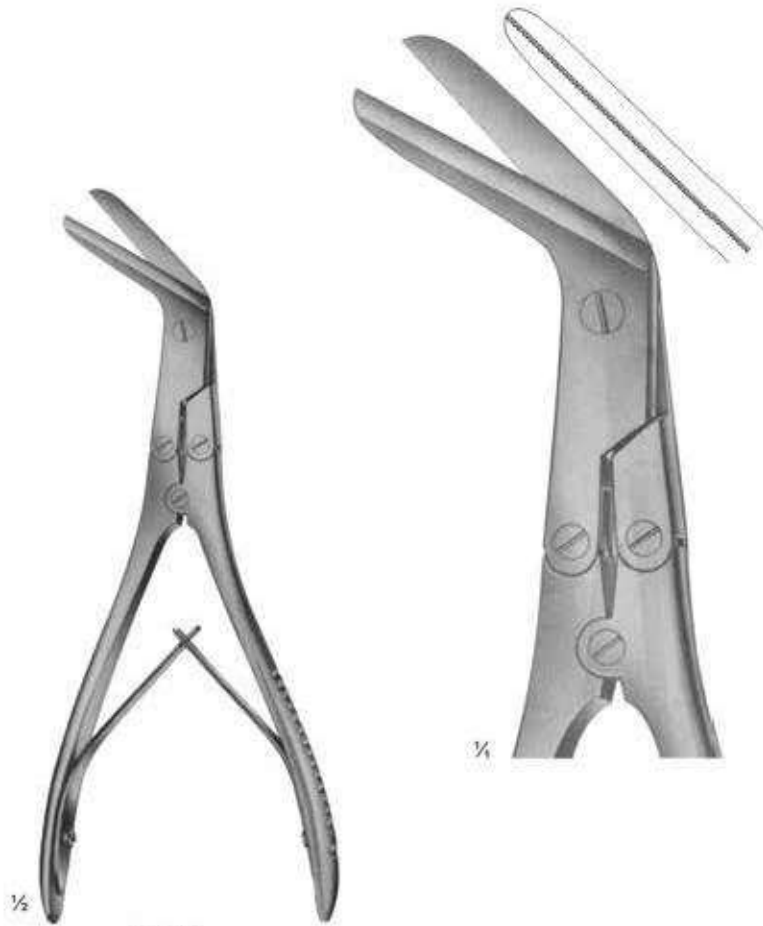

03-210
KILLIAN
Size: 200 mm



03-211 - 03-212



03-211
195 mm



1/4



03-212
225 mm



1/4

Scissors for deep operations and for Gynaecology

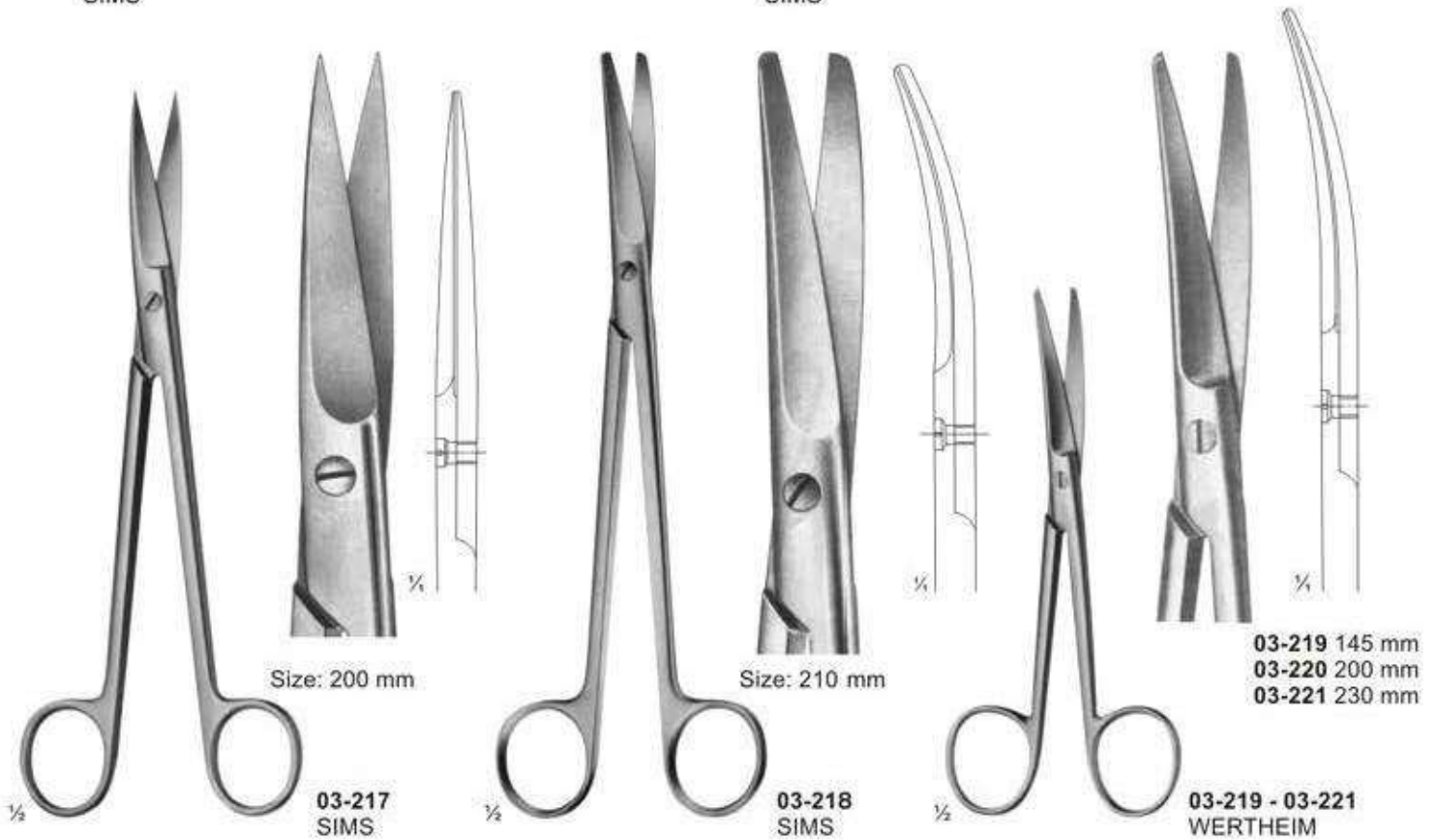
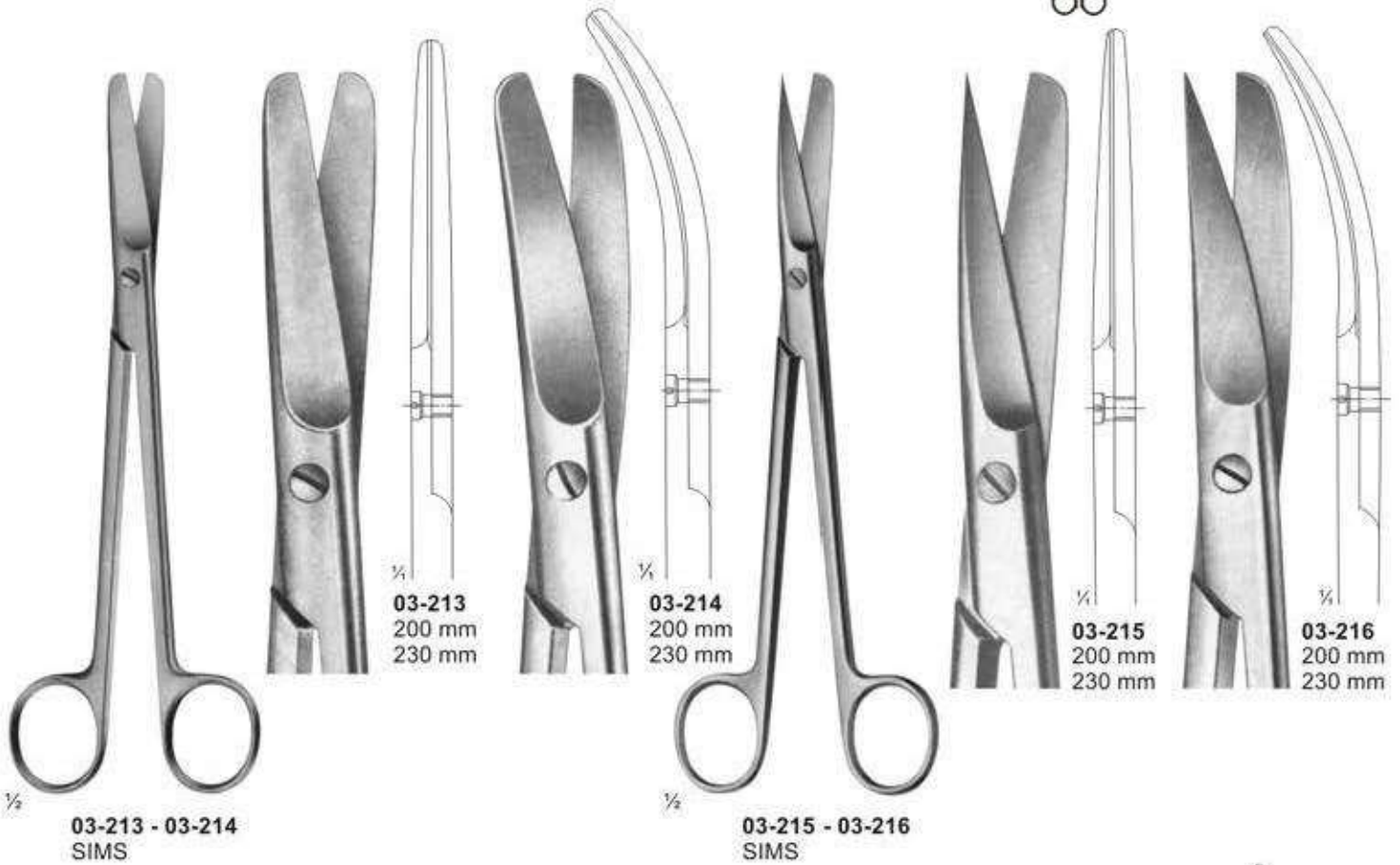



03-222
SCHUMACHER
 Umbilical cord scissors
 Size: 155 mm



03-223
 Umbilical cord scissors
 Size: 105 mm

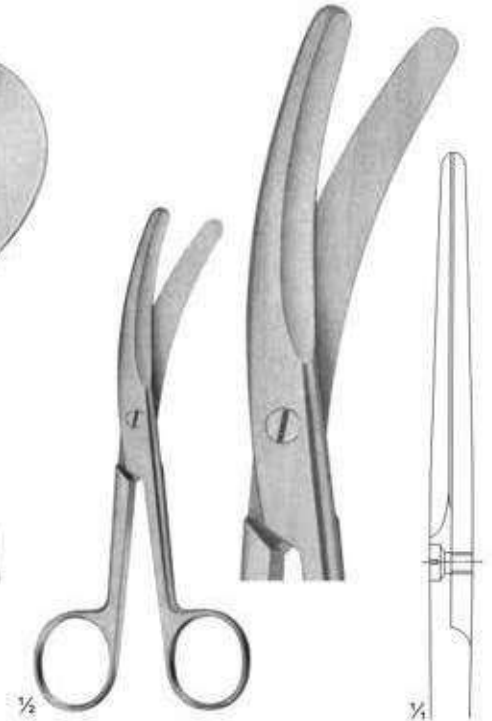

03-224
 Umbilical cord scissors

135 mm



03-225 - 03-226
BRAUN-STADLER
 Episiotomy scissors

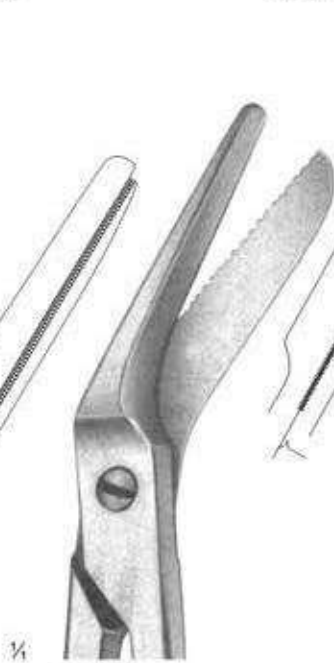

03-225
 145 mm

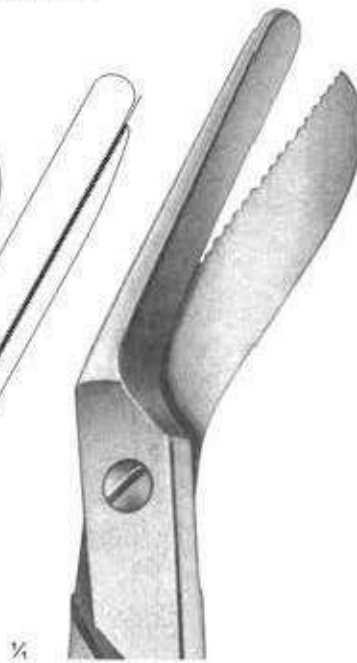

03-226
 200 mm

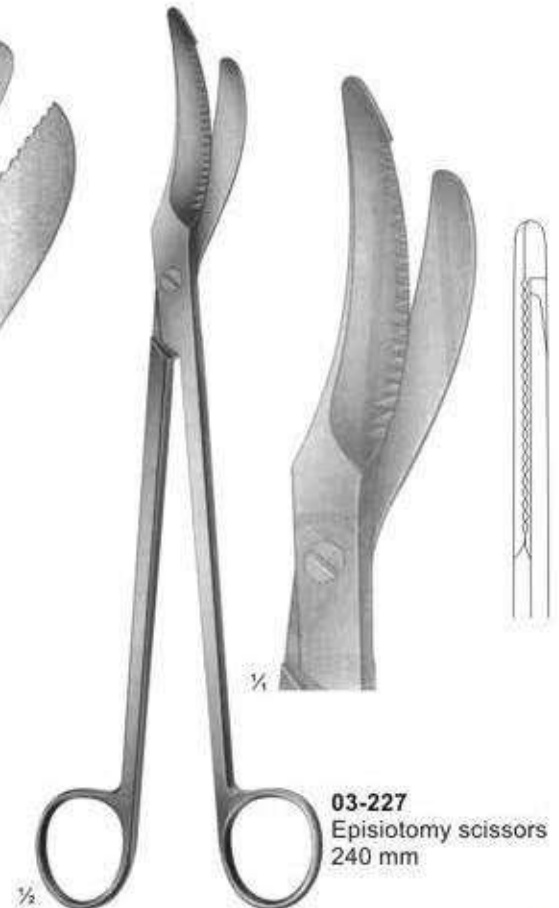

03-227
 Episiotomy scissors
 240 mm

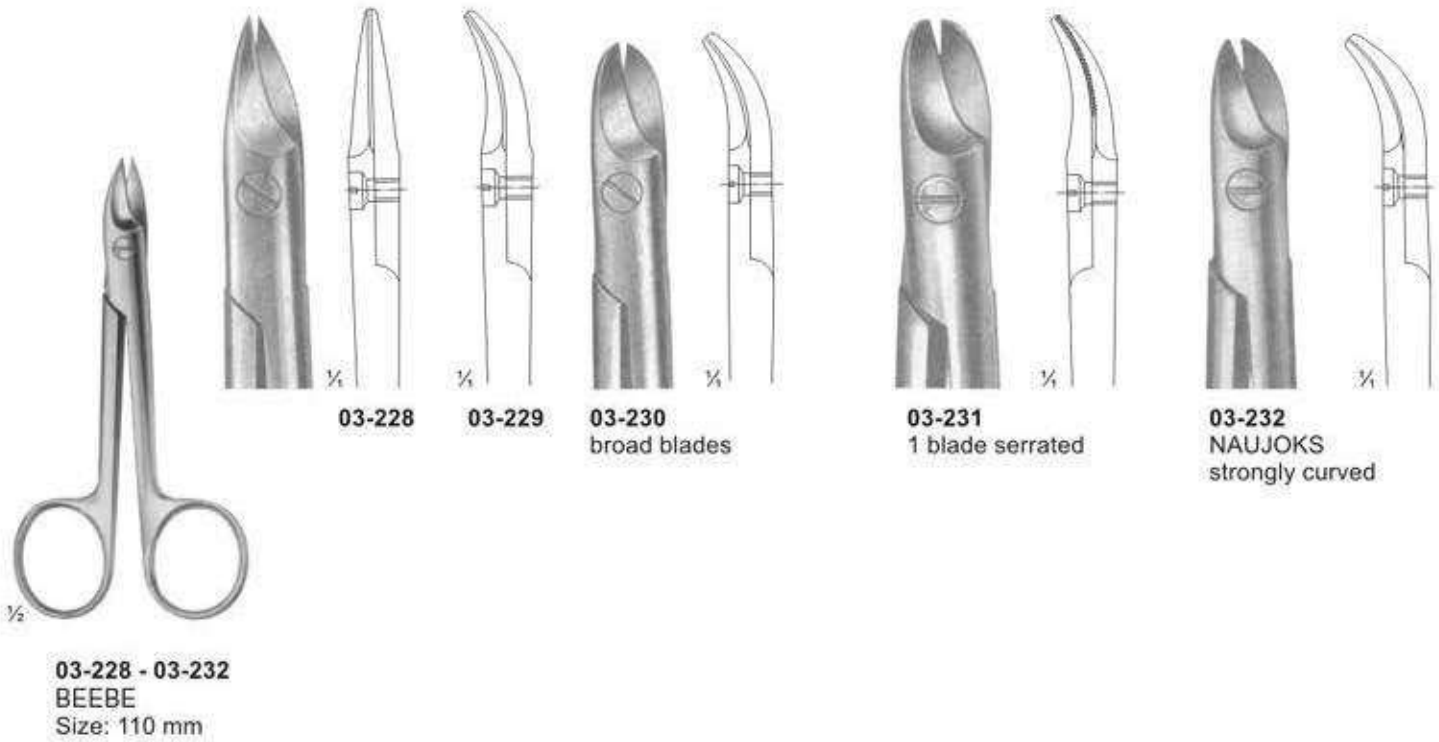



03-236
Universal bandage and cloth scissors,
with toothed edges
180 mm



03-237
LISTER
Universal bandage and cloth scissors,
with toothed edges
Size: 145 mm

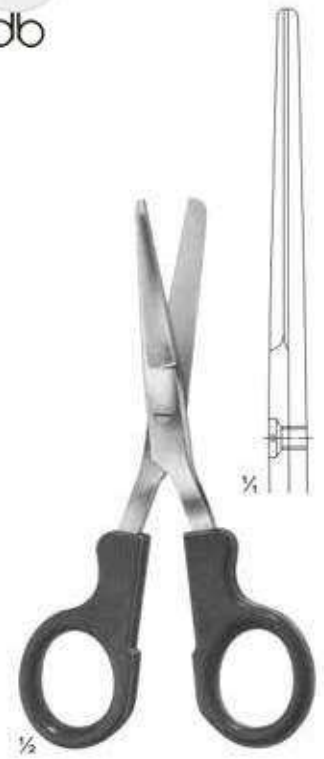

03-238
LISTER
Nurse's scissors
Size: 145 mm

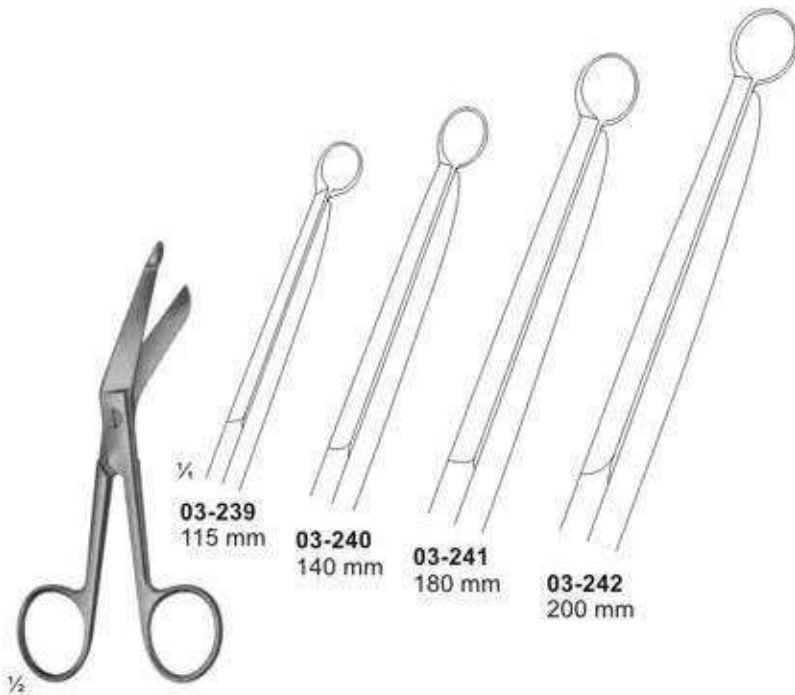

03-239 - 03-242
LISTER

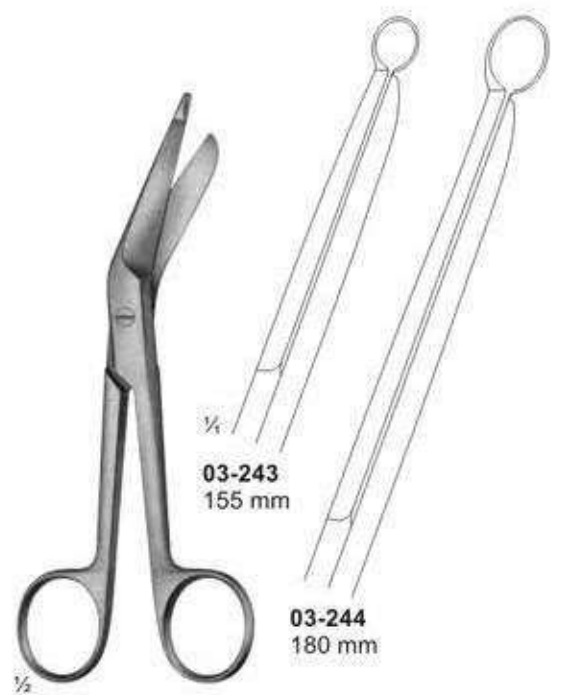

03-243 - 03-244
LISTER

Bandage-, Cloth-, and Plaster Scissors



03-245
CLOTH SCISSORS
205 mm

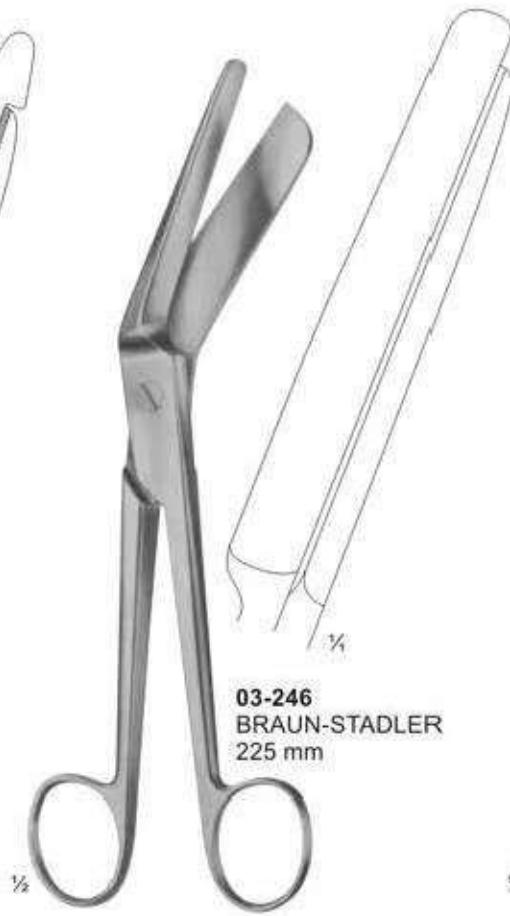

03-246
BRAUN-STADLER
225 mm



03-247
SEUTIN
230 mm



03-248 **03-249**
200 mm 230 mm

03-248 - 03-249
ESMARCH

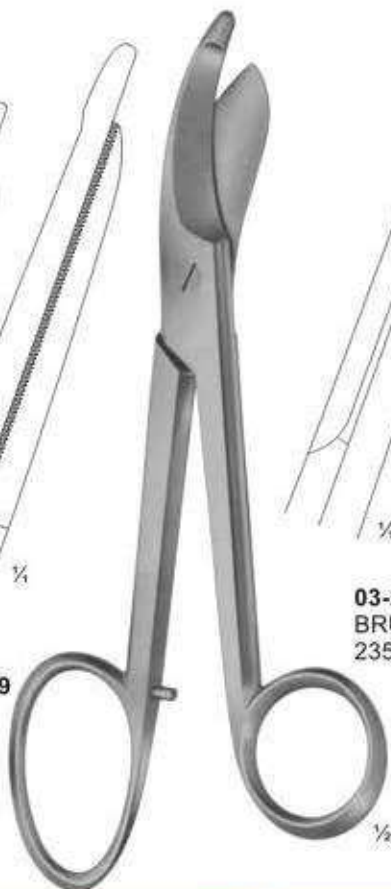

03-250
BRUNS
235 mm

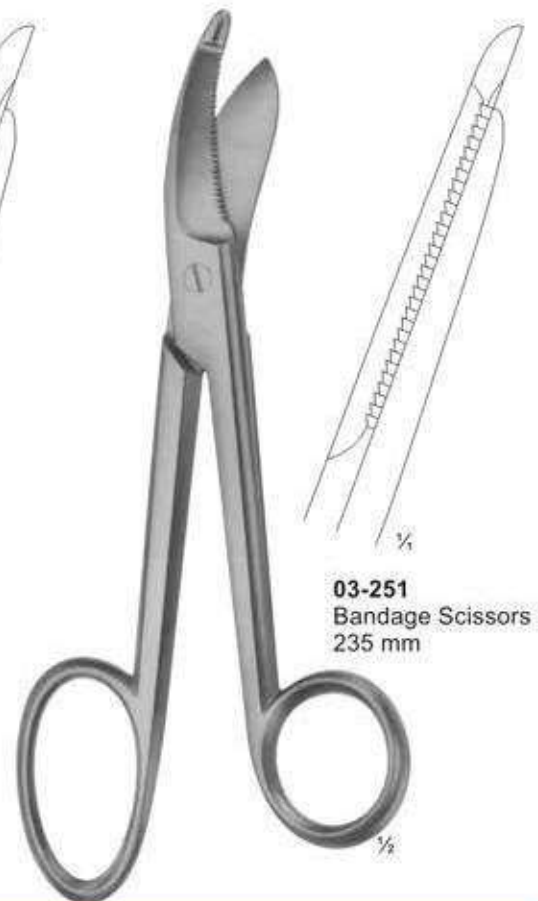

03-251
Bandage Scissors
235 mm

Forceps for grasping tissue, tumors etc.



04-101 04-102 04-103

04-101 - 103
YASARGIL-SAMII
Jaws spoon-shaped
240 mm



04-104 04-105

04-104 - 105
YASARGIL
Jaws spoon-shaped
220 mm

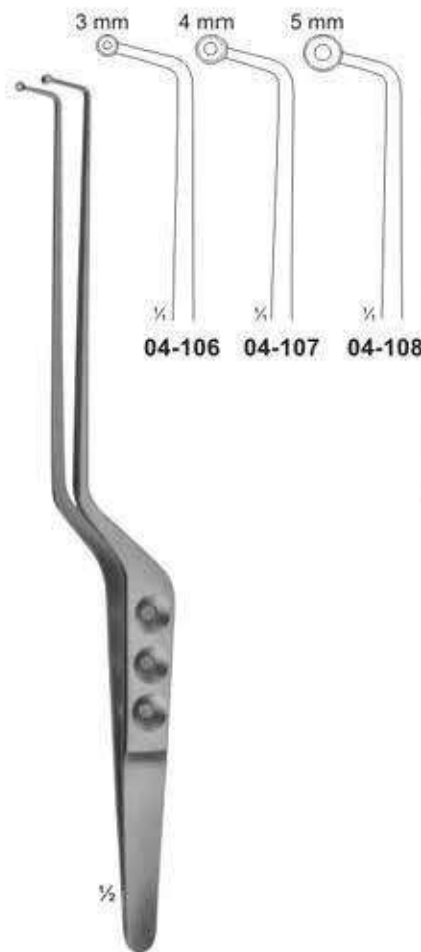

04-106 04-107 04-108

04-106 - 108
SAMII
Jaws spoon-shaped
230 mm



04-109 04-110 04-111

04-109 - 111
SAMII
Jaws spoon-shaped
230 mm

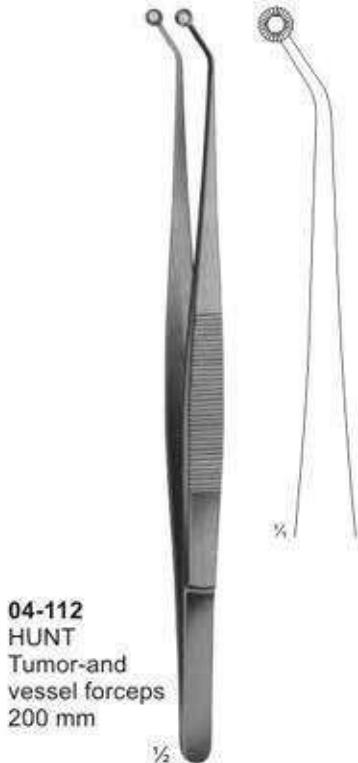

04-112
HUNT
Tumor and
vessel forceps
200 mm



04-113
HUNT
Tumor and
vessel forceps
200 mm



04-114
YASARGIL
Tumor and
vessel forceps
200 mm



04-115
THORPE
Corneal forceps
120 mm



04-116
MICRO-ADSON
120 mm



04-117
ADSON
120 mm



04-118
MICRO-ADSON
150 mm

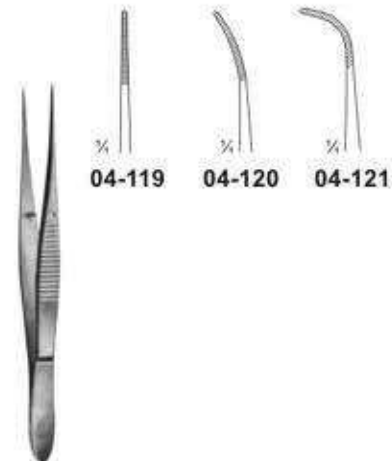

04-119 - 121
100 mm

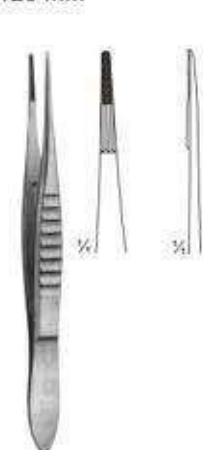

04-122
BONACCOLTO
110 mm



04-123
115 mm

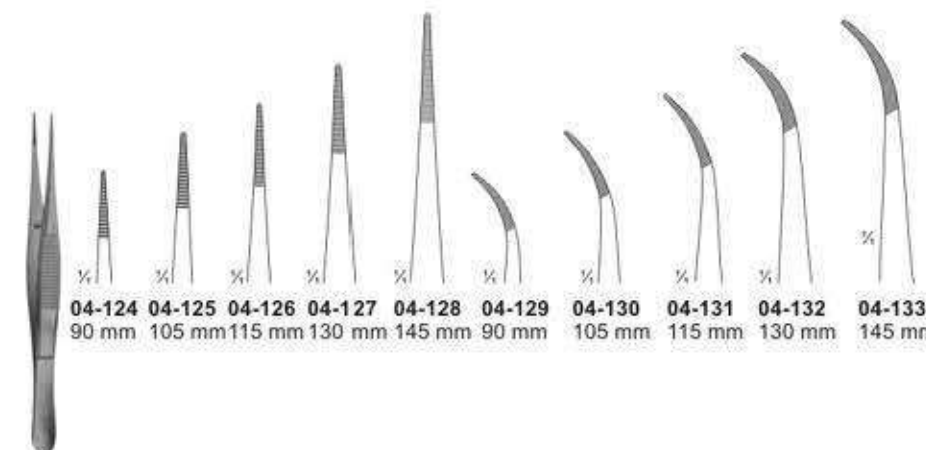

04-124 - 133

04-124 90 mm **04-125** 105 mm **04-126** 115 mm **04-127** 130 mm **04-128** 145 mm **04-129** 90 mm
04-130 105 mm **04-131** 115 mm **04-132** 130 mm **04-133** 145 mm



04-134
100 mm

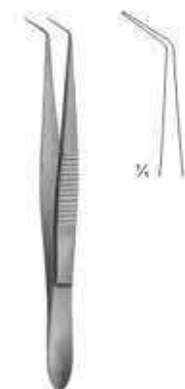

04-135
100 mm



04-136
100 mm

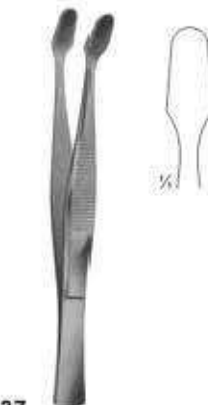

04-137
KUHNE
Cover glass forceps, 105 mm



04-138
160 mm

Delicate Dissecting Forceps

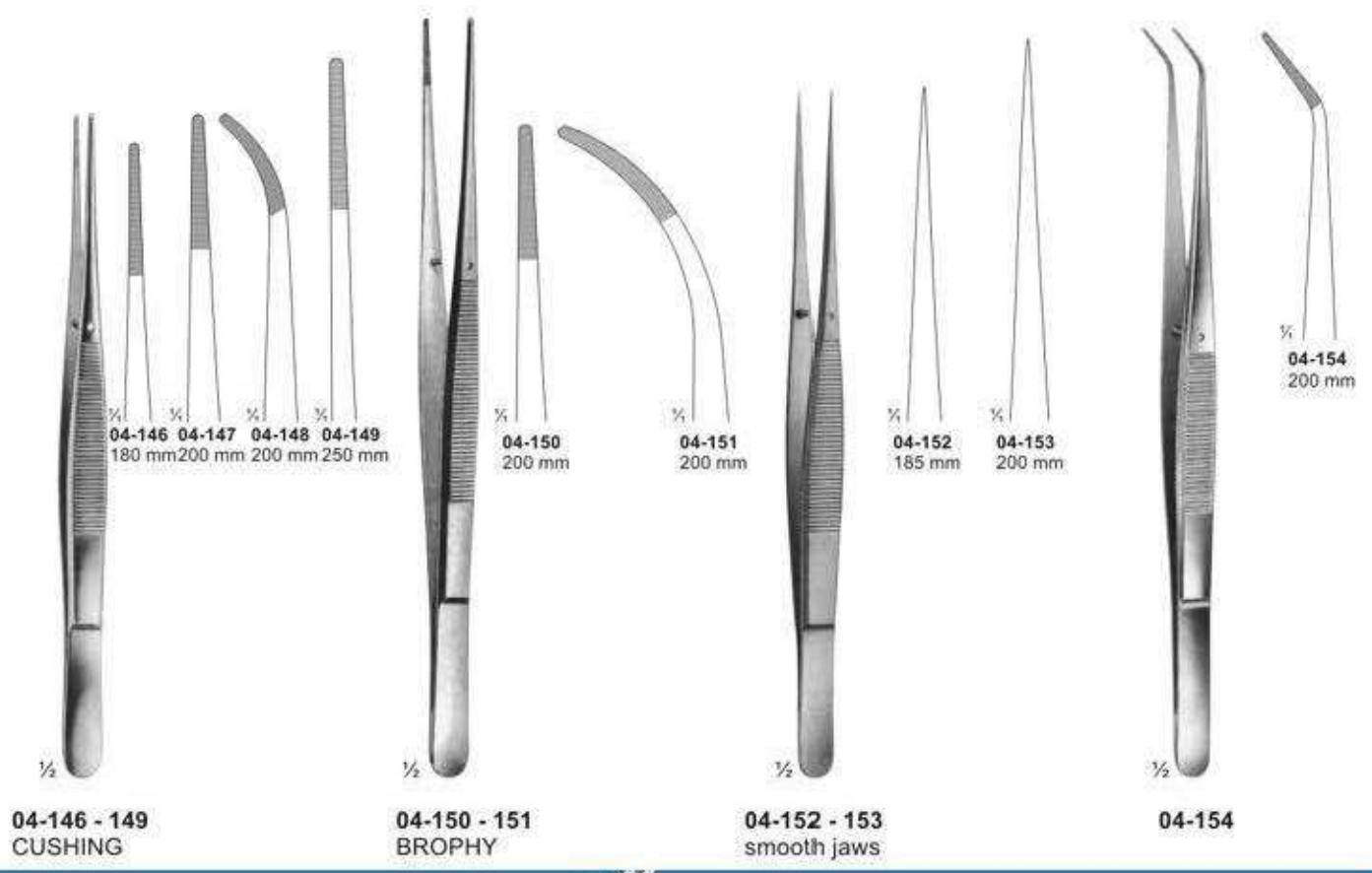
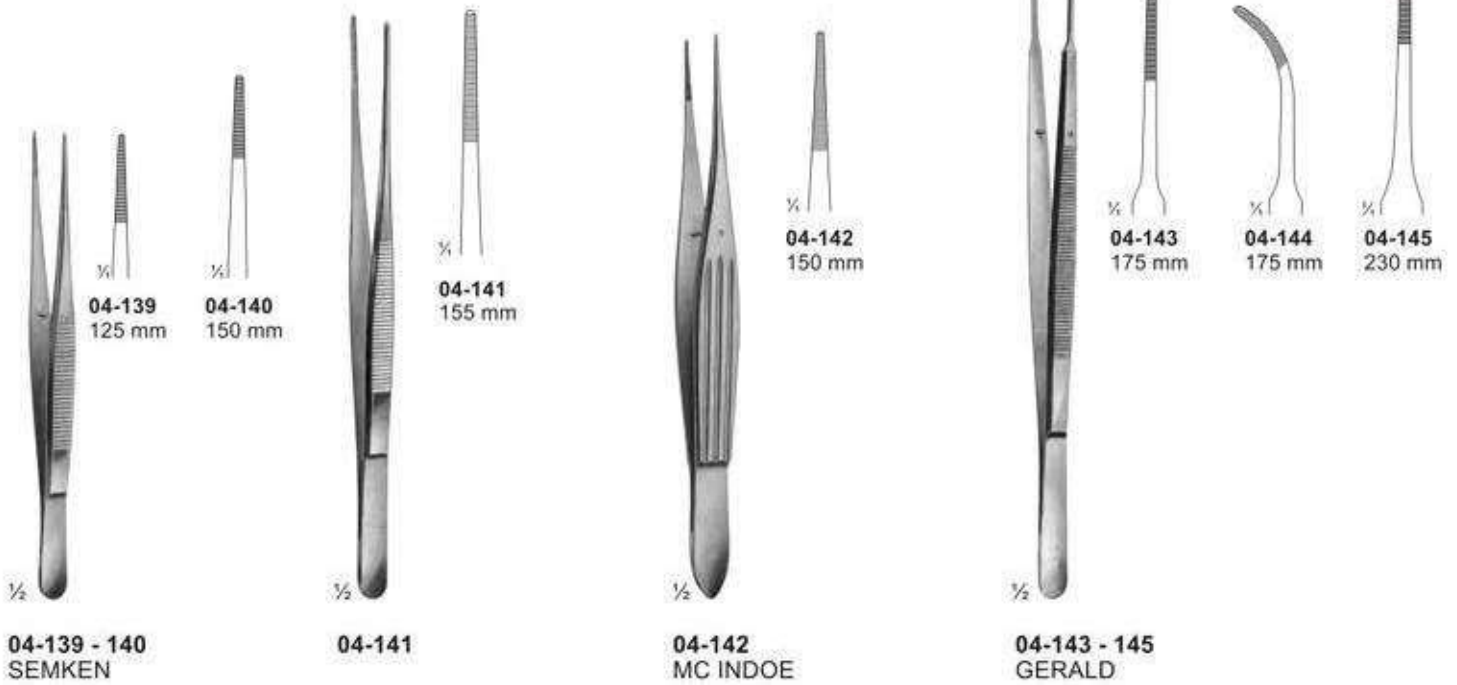

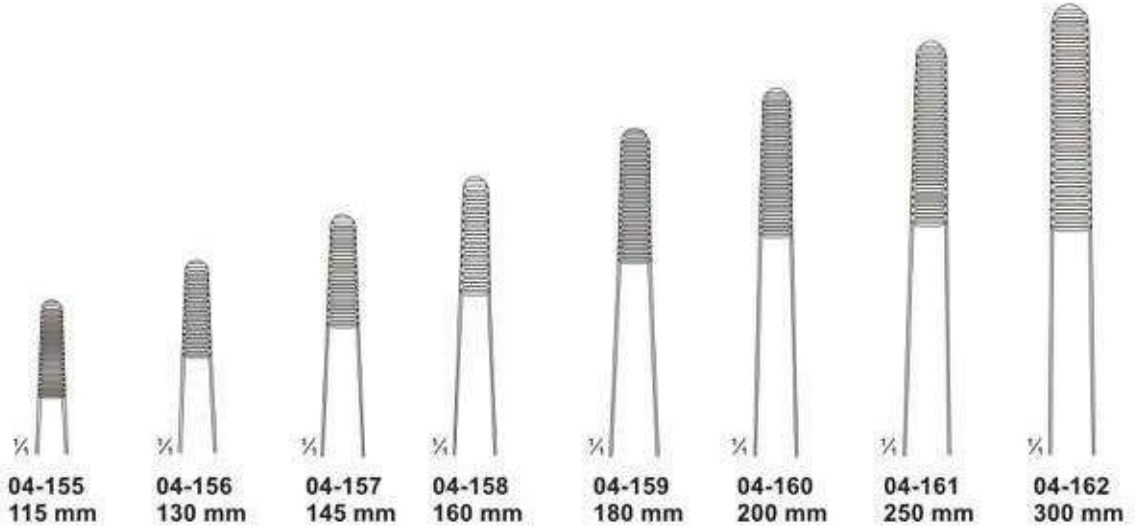

04-155 - 04-162
STANDARD



04-163 - 04-167
MEDIUM



04-168 - 04-169
MEDIUM

Forceps

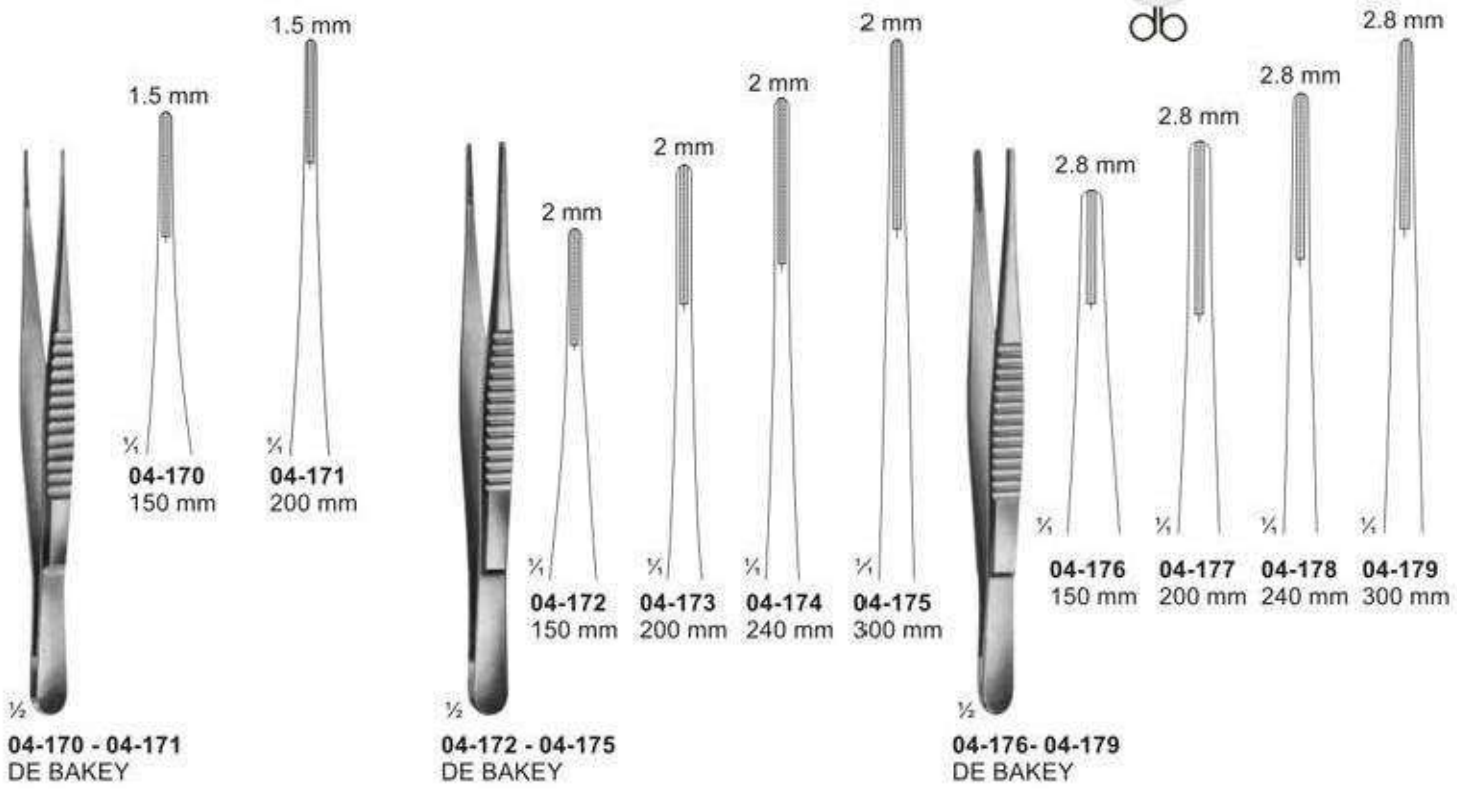



04-185
BISHOP-HARMON
85 mm

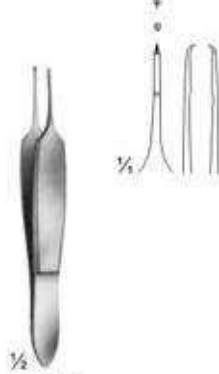

04-186
ST.MARTIN
80 mm

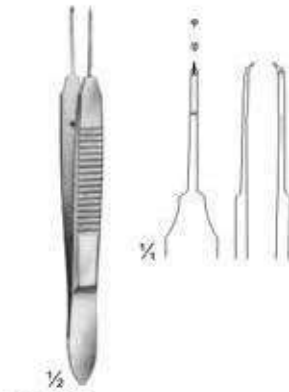

04-187
CASTROVIEJO
teeth 0.9 mm
100 mm



04-188
CASTROVIEJO
teeth 0.5 mm
100 mm



04-189
ELSCHING
110 mm



04-190
GILL
75 mm



04-191
GILL - HESS
75 mm

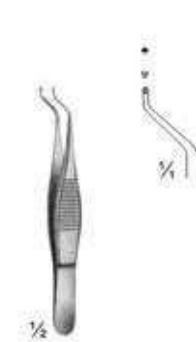

04-192
HESS
70 mm

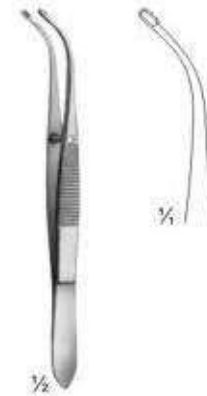

04-193
ARRUGA
100 mm

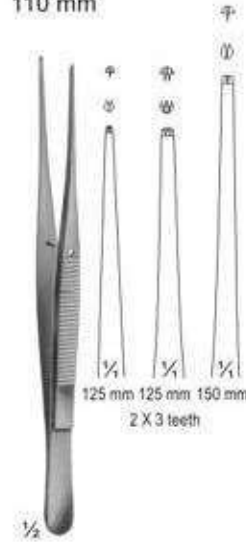

04-194
SEMKEN
125 mm 125 mm 150 mm
2 X 3 teeth



04-195
MICRO-ADSON
120 mm



04-196
ADSON
120 mm



04-197
ADSON
120 mm



04-198
ADSON
120 mm



04-199
ADSON
150 mm

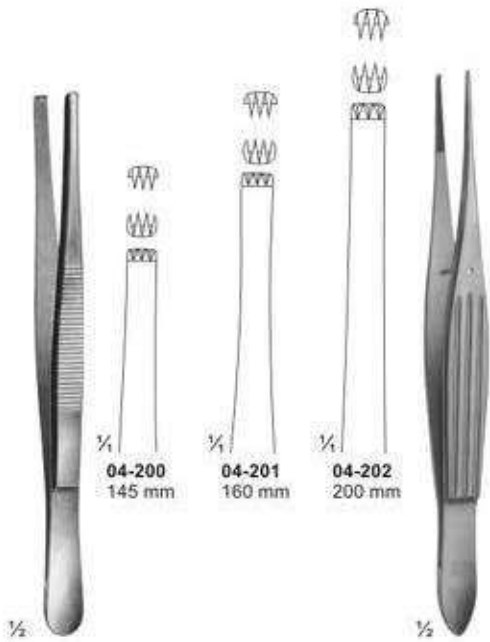

04-200 - 04-203
3x4 teeth



04-203
MC INDOE

04-204
GILLIES



04-204
155 mm



04-205 - 04-207
GERALD



04-205
175 mm



04-206
175 mm



04-207
230 mm



04-208 - 04-211
WAUGH



04-208
180 mm



04-209
200 mm



04-210
250 mm

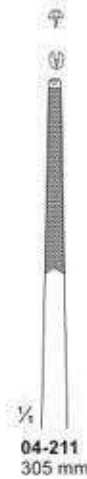

04-211
305 mm



04-212
BROPHY



04-212
200 mm



04-213
ADSON - BROWN
Non-traumatic
120 mm



04-214
BROWN
120 mm



04-215
GRAEFE
110 mm



04-216
GRAEFE
With Catch
110 mm

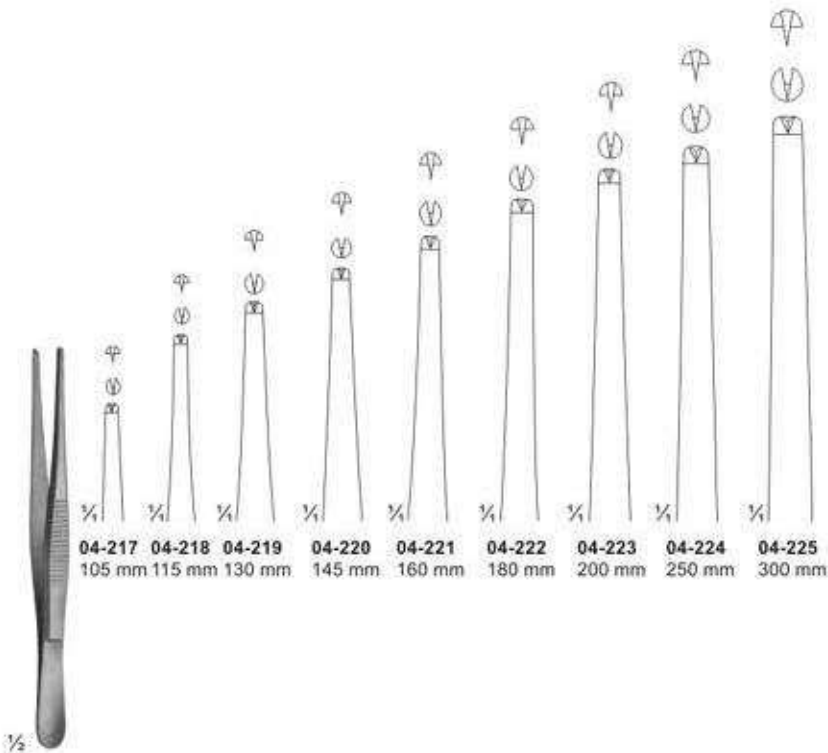

04-217 - 04-225
STANDARD

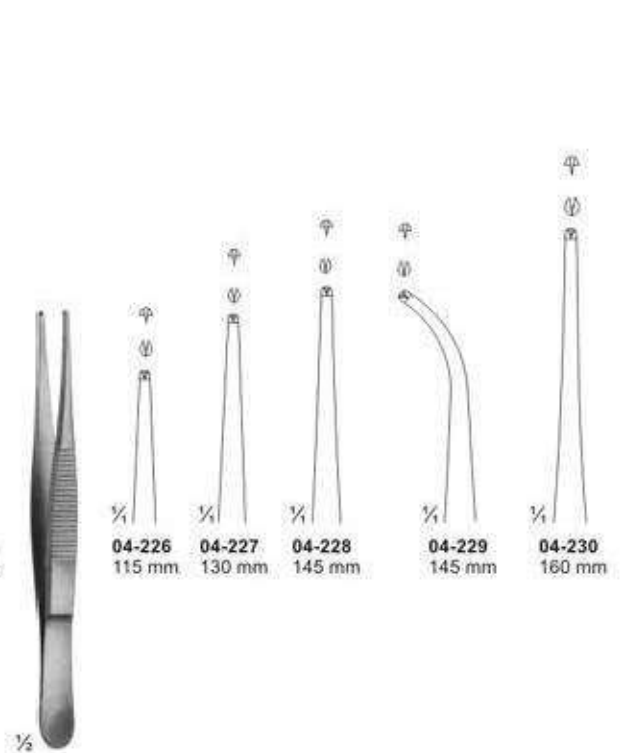

04-226 - 04-230
GRAEFE
110 mm

Forceps, Bayonet - Shaped

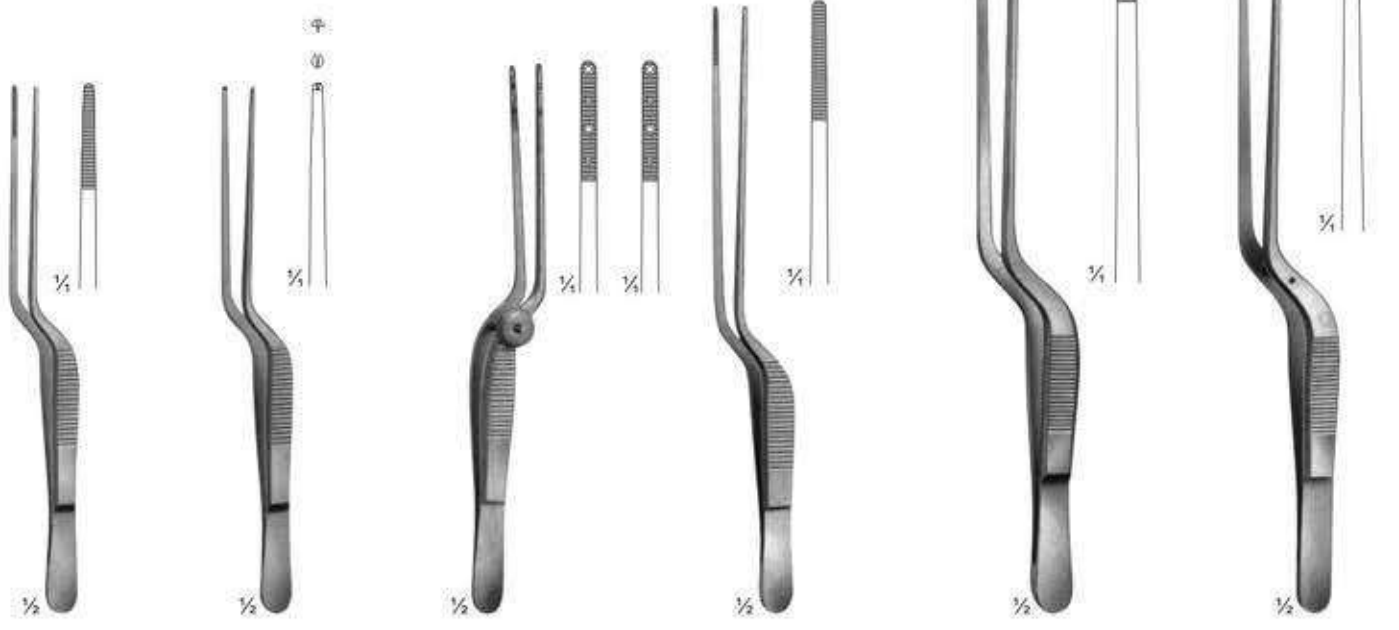

04-231
LUCAE
140 mm

04-232
LUCAE
1x2 teeth
140 mm

04-233
COTTLE
Forceps with
jaws toothed
and serrated
140 mm

04-234
JANSEN
160 mm

04-235
GRUENWALD
200 mm

04-236
1x2 teeth
200 mm

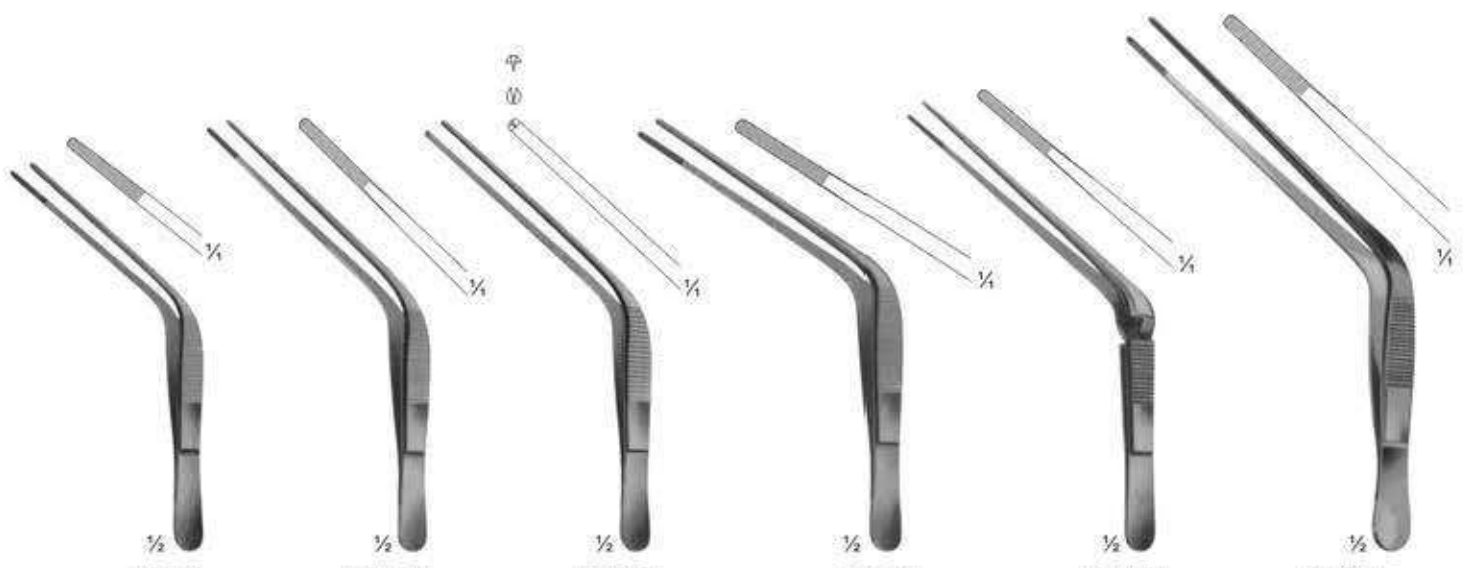

04-237
TROELTSCH
100 mm

04-238
TROELTSCH
115 mm

04-239
TROELTSCH
1X2 teeth
115 mm

04-240
WILDE
115 mm

04-241
TROELTSCH
Cross action
120 mm

04-242
TROELTSCH
140 mm

Tissue Forceps, Lung Dissecting Forceps

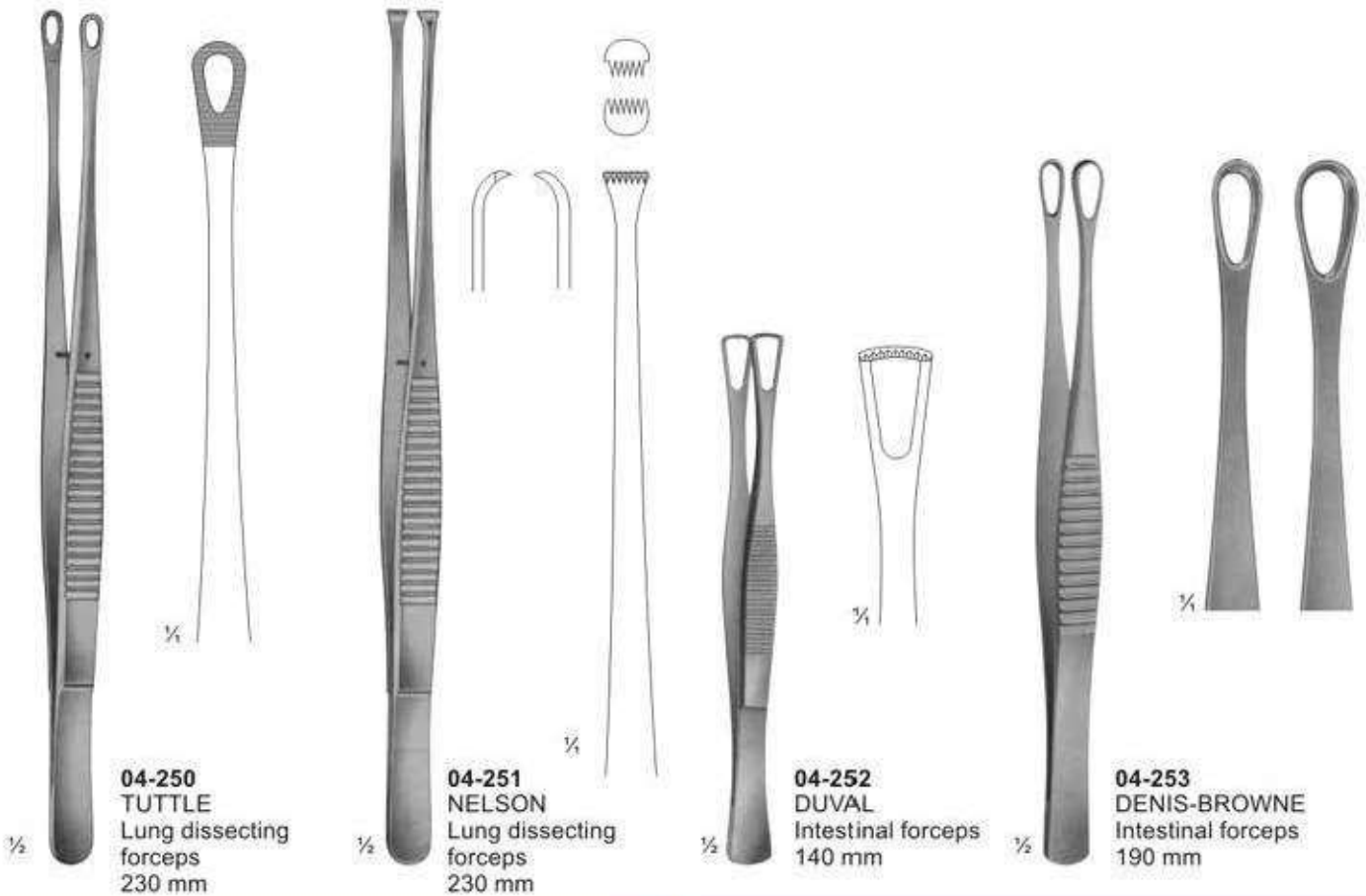
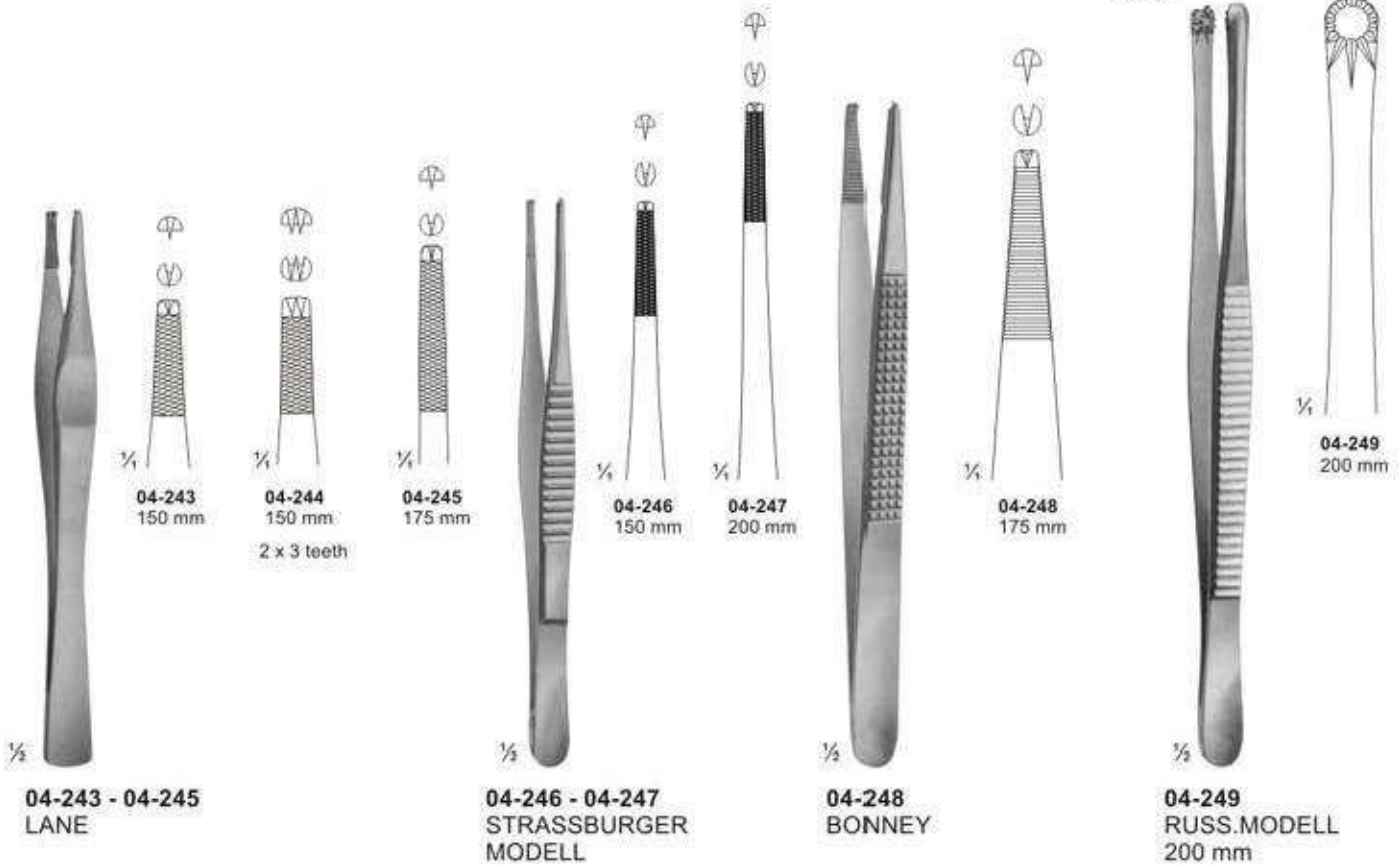

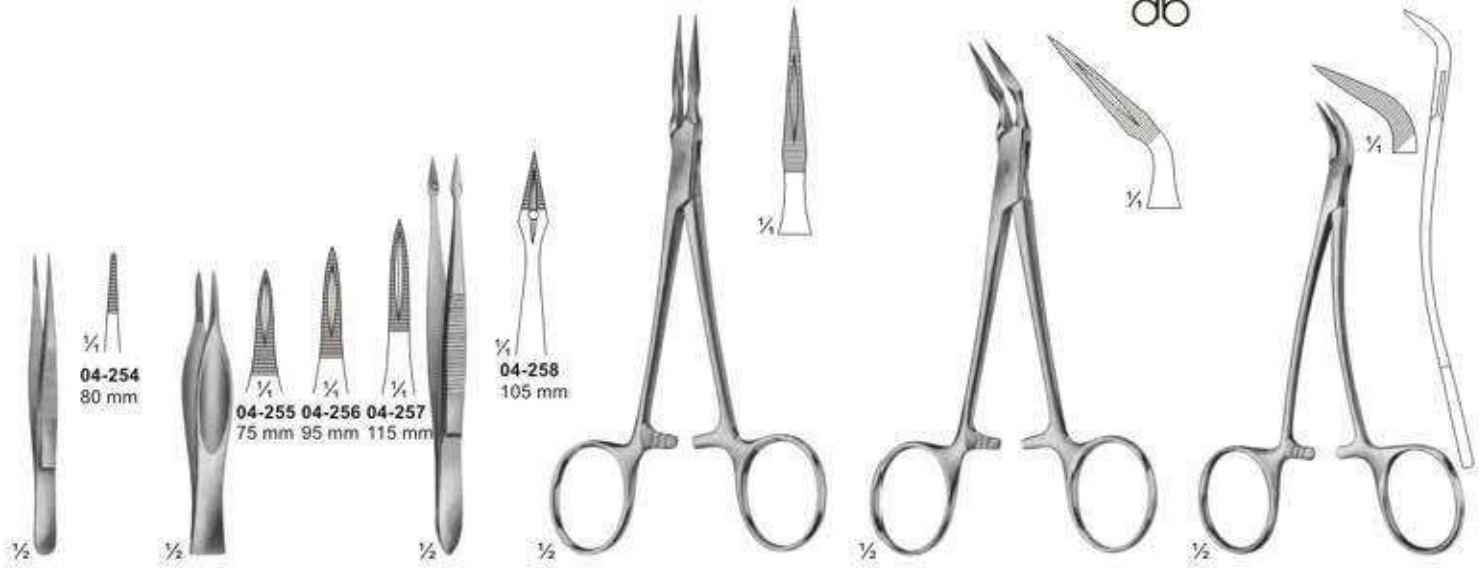

04-254

04-255 - 04-257
FEILCHENFELD

04-258
HUNTER

04-259
STIEGLITZ
140 mm

04-260
STIEGLITZ
140 mm

04-261
PEET
120 mm



04-262
BEER
85 mm



04-263
85 mm



04-264
85 mm



04-265
BERGH
105 mm

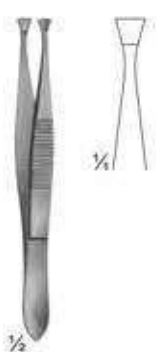

04-266
85 mm

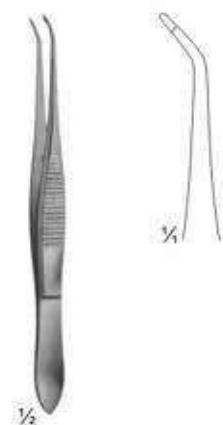

04-267
SAUPE
105 mm



04-268
SCHAAF
95 mm



04-269
105 mm

Sponge and Dressing Forceps

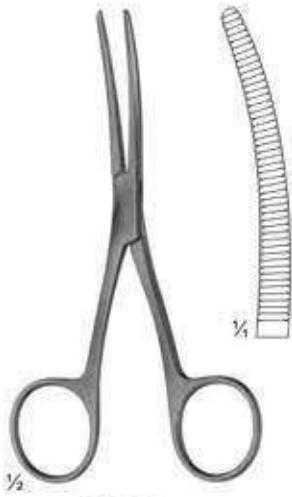

04-270
BRYANT
130 mm

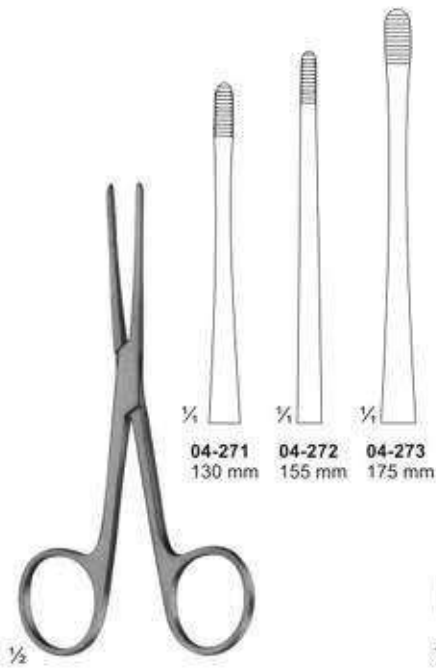

04-271 - 04-273
LISTER
Sinus forceps

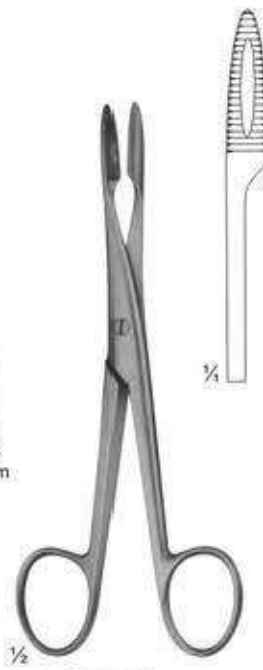

04-274
without ratchet
145 mm

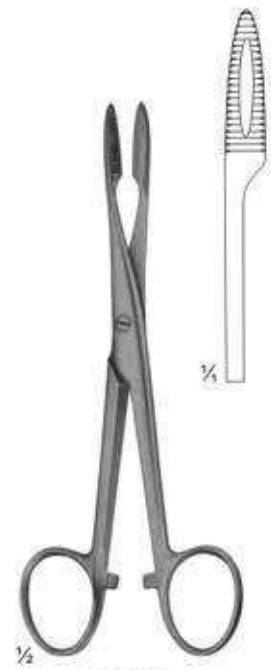

04-275
with ratchet
145 mm

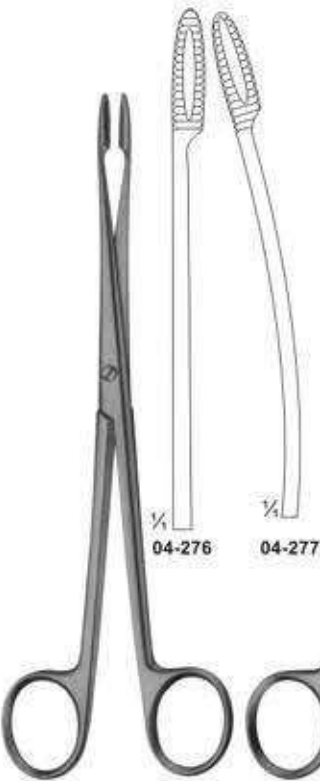

04-276 - 04-277
GROSS
without ratchet
180 mm

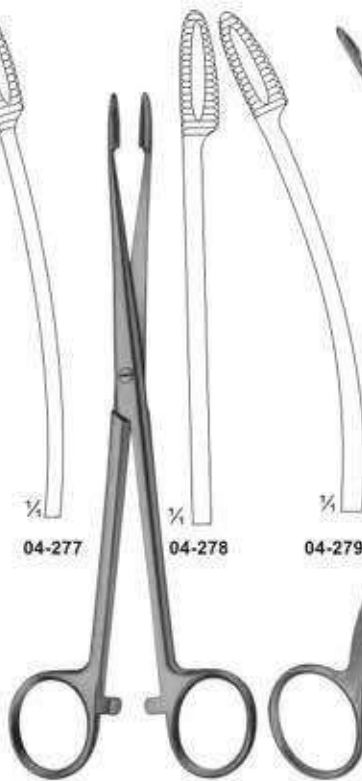

04-278 - 04-279
GROSS
with ratchet
180 mm

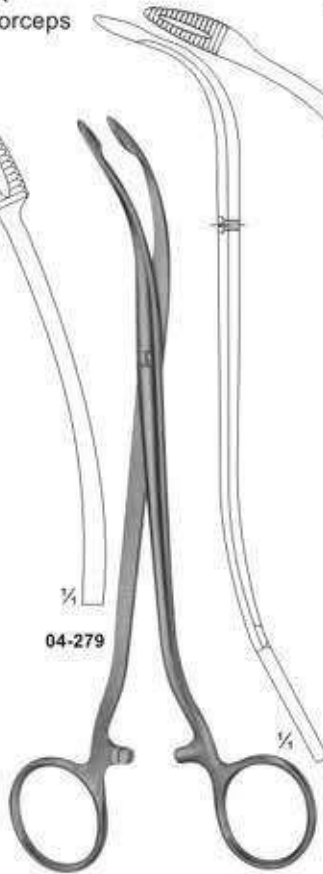

04-280
DUPLAY
190 mm

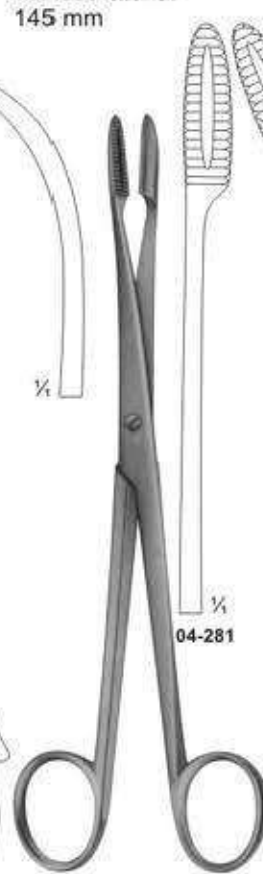

04-281 - 04-282
GROSS
without ratchet
200 mm

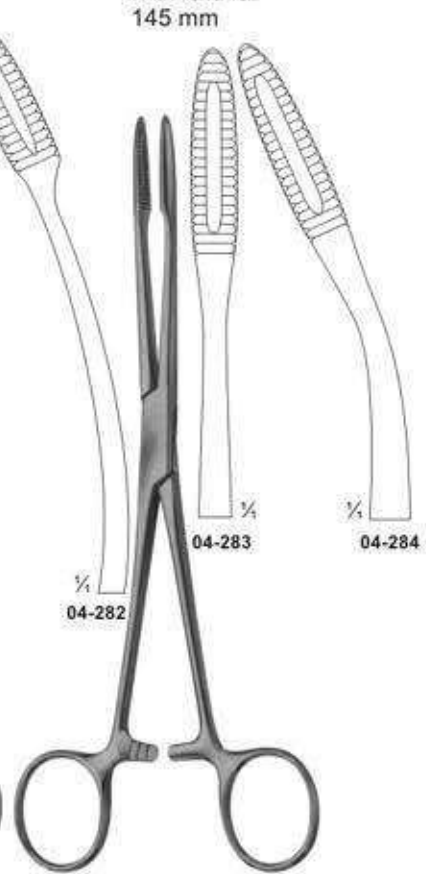

04-283 - 04-284
GROSS
200 mm

Dressing-, Sponge holding-, Organ- and Tissue Grasping Forceps

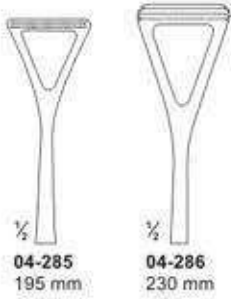

04-285 - 04-286
COLLIN

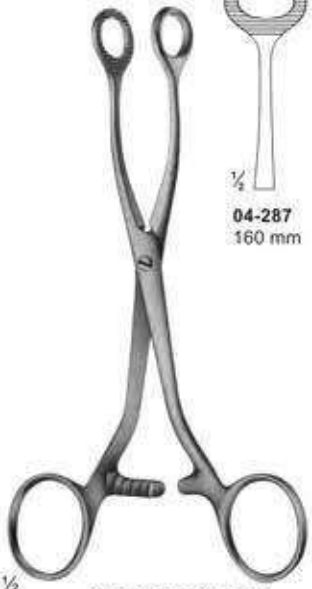

04-287 - 04-289
COLLIN

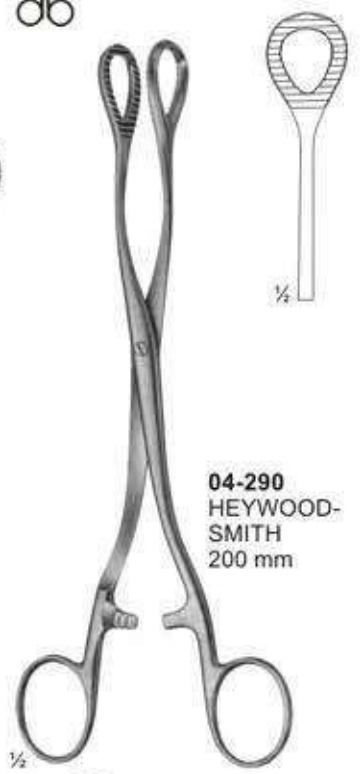

04-290
HEYWOOD-SMITH
200 mm



04-291
NOTO
280 mm



04-292
KELLY
320 mm



Dressing, Sponge holding, Organ and Tissue Grasping Forceps

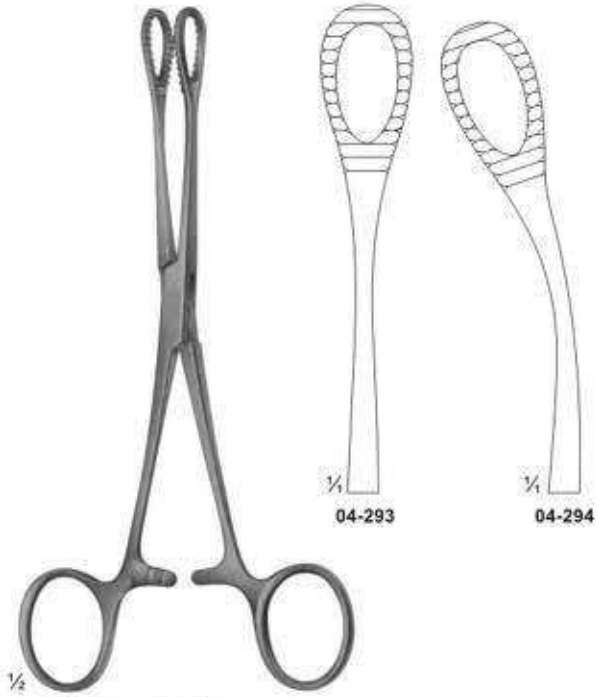

04-293

04-294

1/2
04-293 - 04-294
FOERSTER-BALLENGER
180 mm

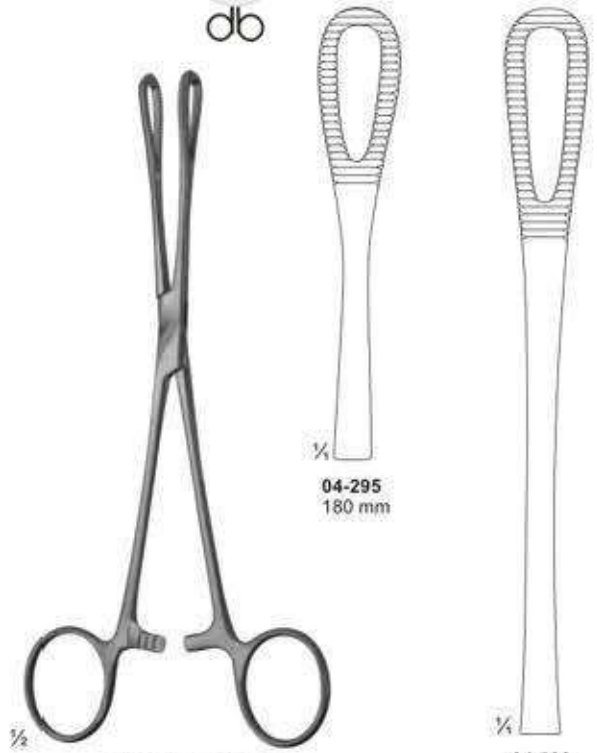

1/4
04-295
180 mm

1/4
04-296
250 mm

1/2
04-295 - 04-296
RAMPLEY



1/4
04-297
Smooth Jaws

1/4
04-298
Smooth Jaws

1/4
04-299
Serrated Jaws

1/4
04-300
Serrated Jaws

1/2
04-297 - 04-300
FOERSTER-BALLENGER
240 mm

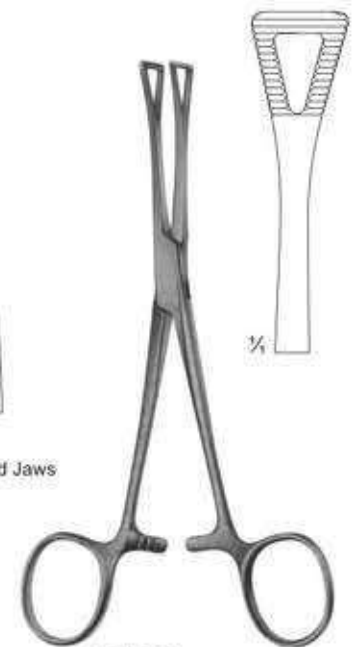

1/4
04-301
PENNINGTON
155 mm

Intestinal Grasping Forceps

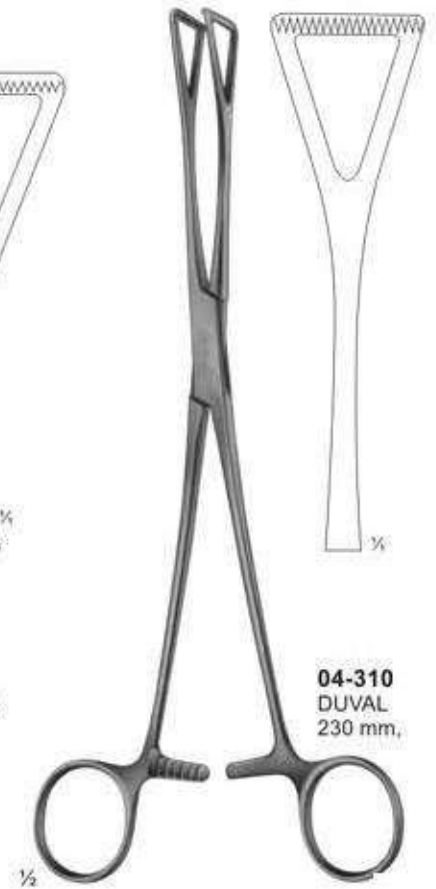
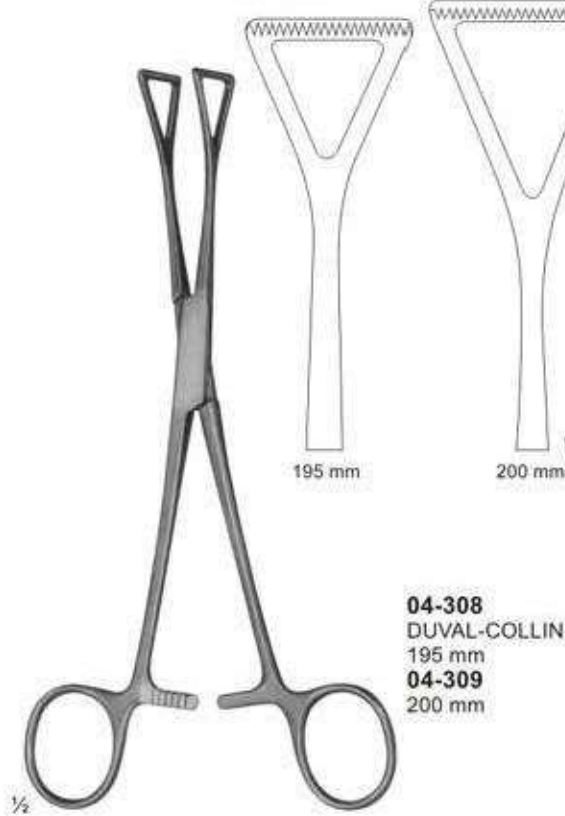
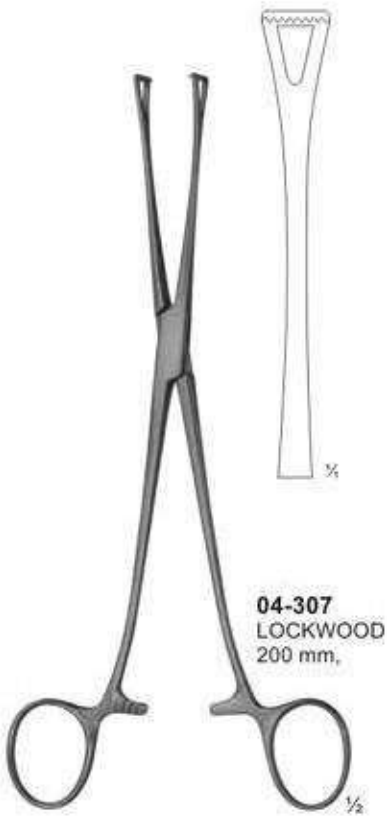
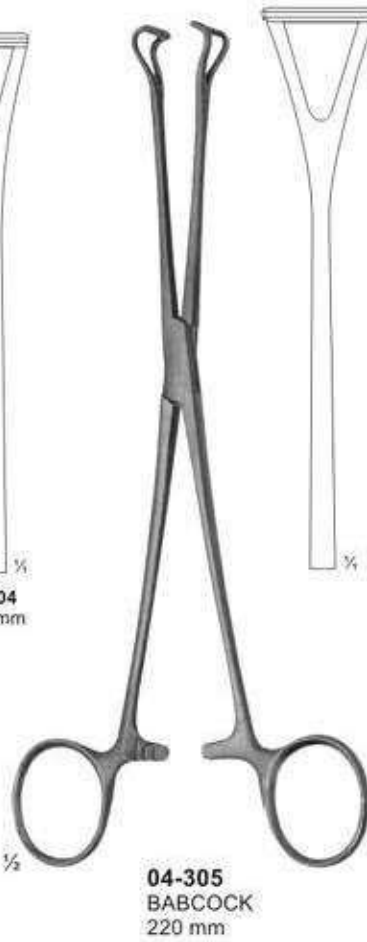
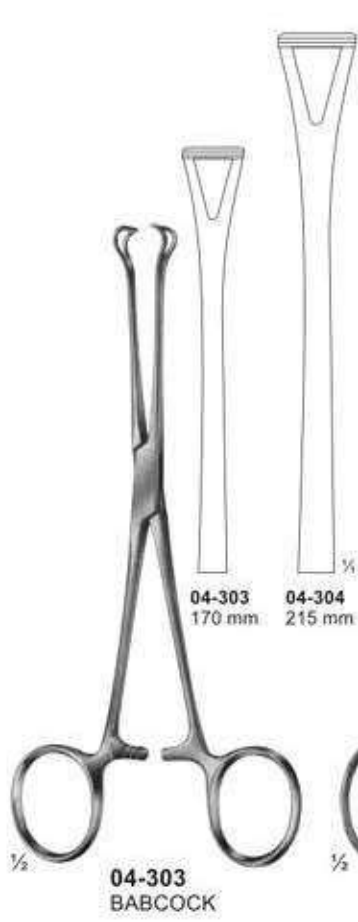
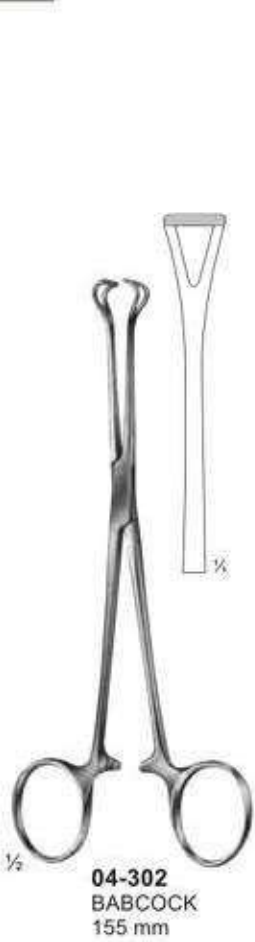

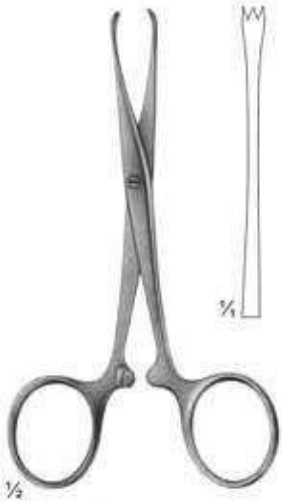

04-311
CHAPUT
2 x 3 teeth
125 mm

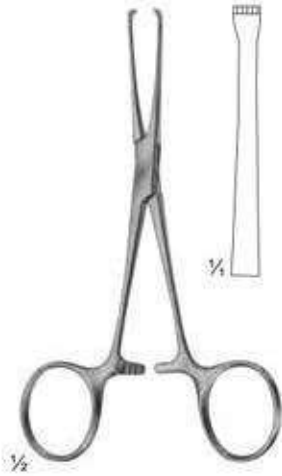

04-312
BABY-ALLIS
4 x 5 teeth
130 mm



04-313
BOYS-ALLIS
5 x 6 teeth sharp
155 mm

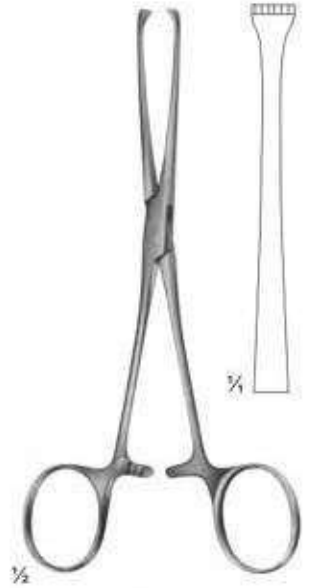

04-314
ALLIS
5 x 6 teeth
155 mm



04-315
LAHEY
155 mm

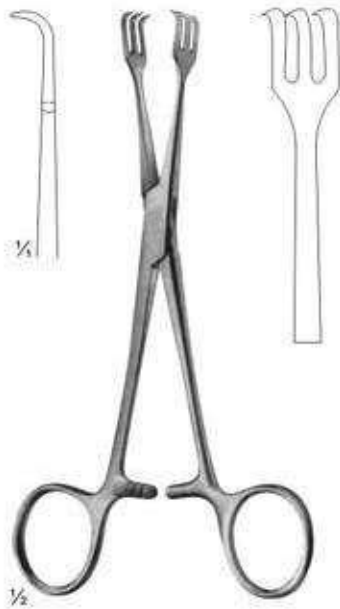

04-316
LAHEY
155 mm

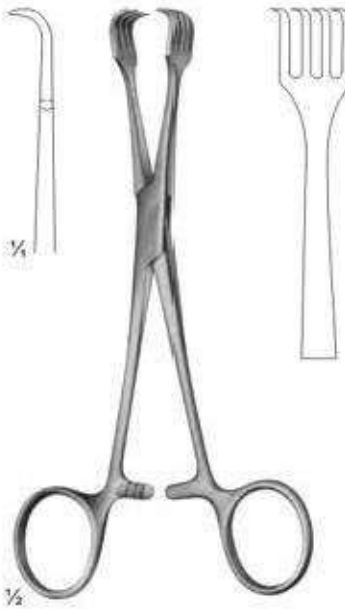

04-317
BRAUN
155 mm

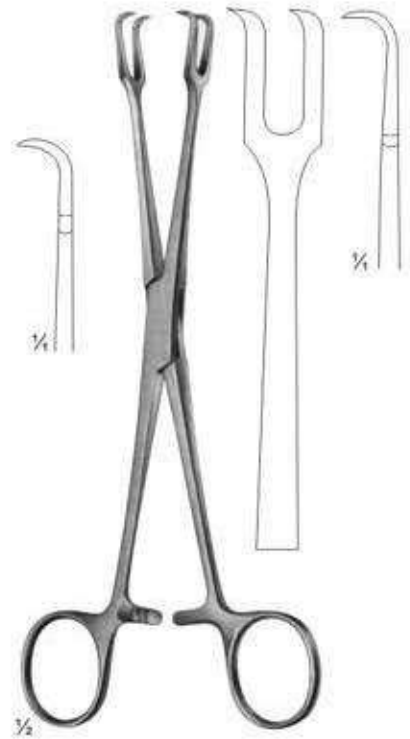

04-318
MUSEUX
200 mm



04-319
JONES
85 mm

04-320
ENGL. MOD.
85 mm

04-321 - 04-322
SCHAEDEL
85 mm

04-323
DOYEN
110 mm

04-324
DOYEN
180 mm

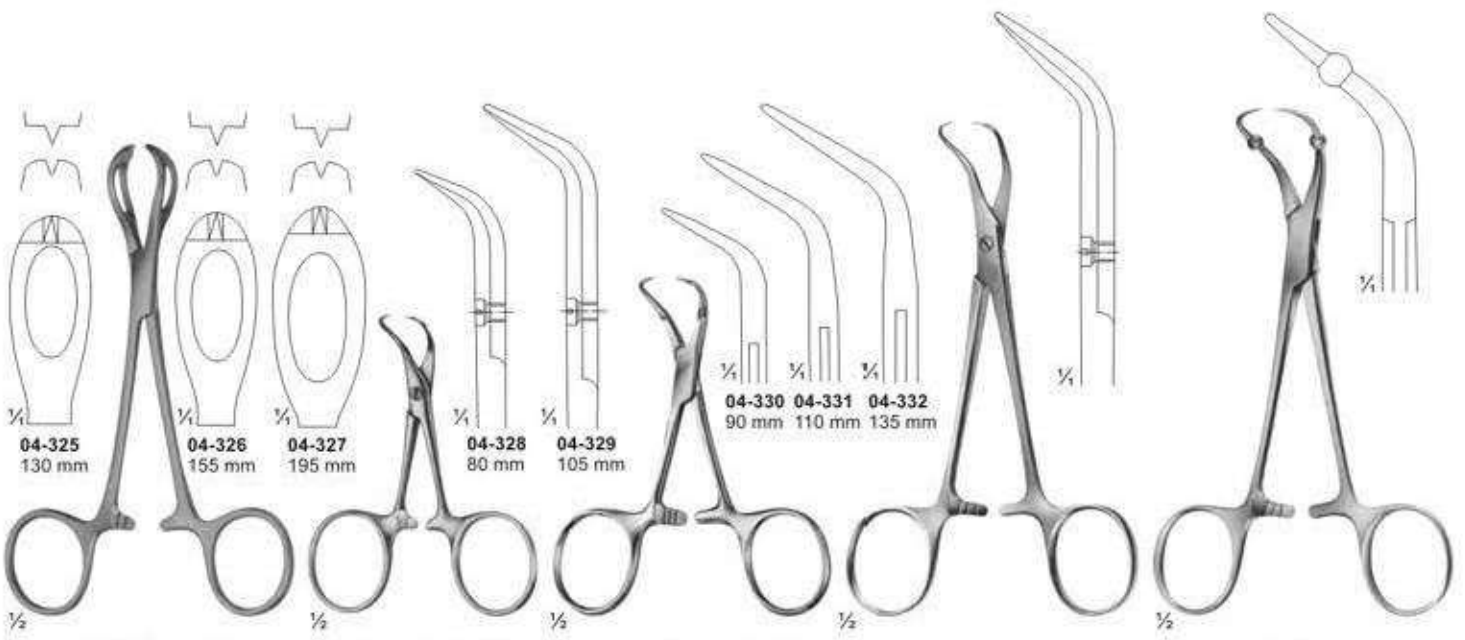

04-325
130 mm

04-326
155 mm

04-327
195 mm

04-328
80 mm

04-329
105 mm

04-330 04-331 04-332
90 mm 110 mm 135 mm

04-325 - 04-327
LANE

04-328 - 04-329
BACKHAUS

04-330 - 04-332
BACKHAUS

04-333
BACKHAUS-KOCHER
135 mm

04-334
ROEDER
135 mm

Closing force



04-335
straight



04-336
curved



04-337
curved tips



04-338
angled shaped



04-339
MULLER
knee-bent



04-340
Muller
Ligature Forceps



04-341
straight

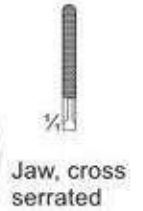

04-341
35 mm



04-342
35 mm



04-343
45 mm



04-344
45 mm



04-345
04-346
38 mm
48 mm



04-347
04-348
38 mm
48 mm



04-349
58 mm



04-350
58 mm



04-351 - 04-357
91 mm



04-358
DE BAKEY-
HESS
20 mm

- 04-351** 38 mm
- 04-352** 48 mm
- 04-353** 56 mm
- 04-354** 63 mm
- 04-355** 70 mm
- 04-356** 80 mm
- 04-357** 91 mm



04-359
length
50 mm
jaws
27 mm



04-360
length
48 mm
jaws
27 mm



04-361
GLOVER
length
57 mm
jaws 35 mm



04-362
DE BAKEY
length 73 mm
jaws 38 mm



04-363
DE BAKEY
length 99 mm
jaws 63 mm



04-364
DE BAKEY
length 95 mm
jaws 54 mm



04-365
L. 80 mm



04-366
L. 90 mm



04-367
L. 105 mm



04-368
L. 124 mm

04-369
L. 78 mm

04-370
L. 68 mm

04-371
L. 86 mm

04-372
L. 97 mm

04-373
L. 96 mm

04-374
L. 117 mm

04-375
L. 117 mm

04-376
L. 65 mm

Delicate Haemostatic Forceps

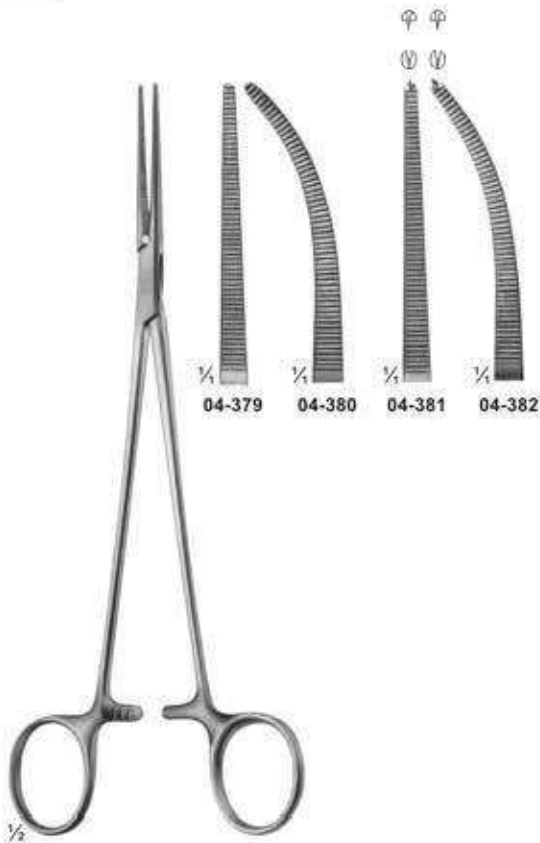

04-379 - 04-382
 HALSTED-MOSQUITO
 200 mm

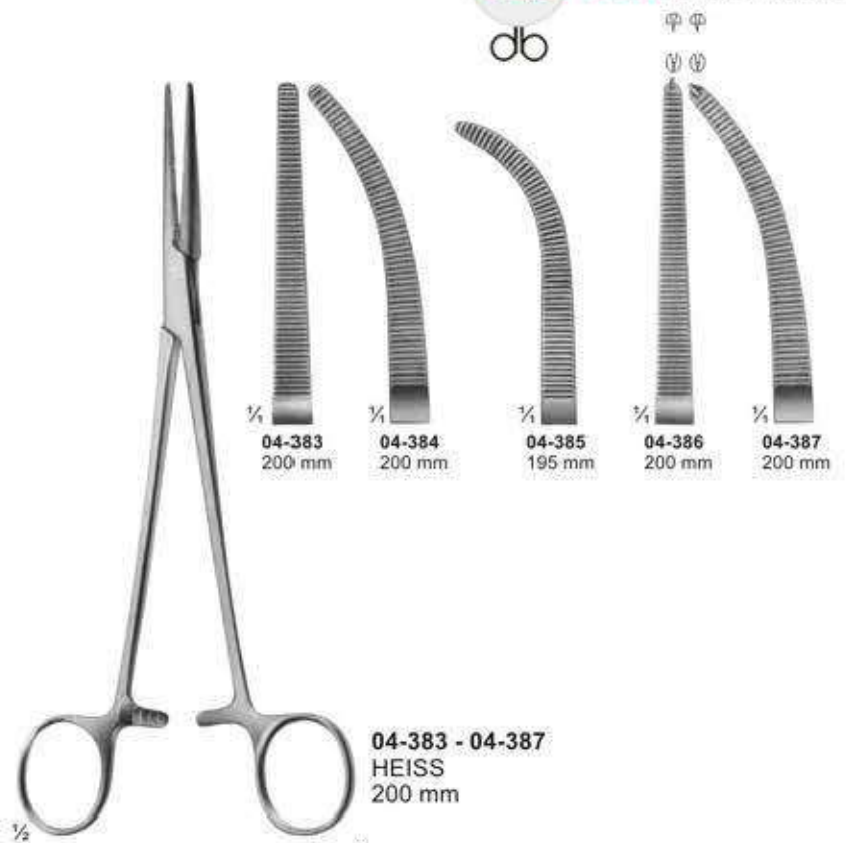

04-383 - 04-387
 HEISS
 200 mm



04-388 - 04-389
 HALSTED
 215 mm

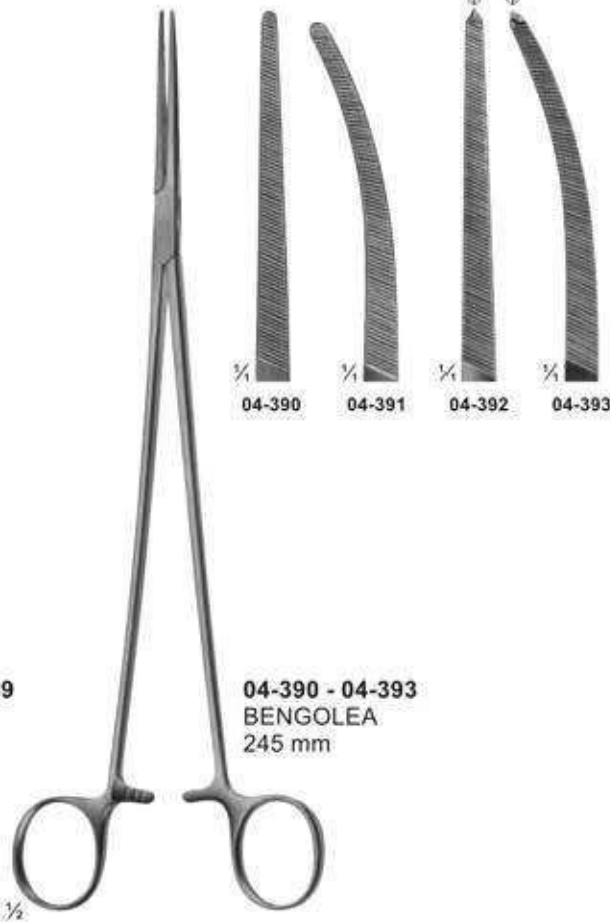

04-390 - 04-393
 BENGOLEA
 245 mm



04-394
 CRAFOORD
 245 mm

Delicate Haemostatic Forceps



04-395
CARREL
85 mm



04-396 - 04-399
BABY-MOSQUITO
(HARTMANN)
100 mm



04-400 - 04-403
MICRO-HALSTED
125 mm



04-404 - 04-407
HALSTED-MOSQUITO
125 mm



04-408 - 04-409
PROVIDENCE-HOSPITAL
140 mm

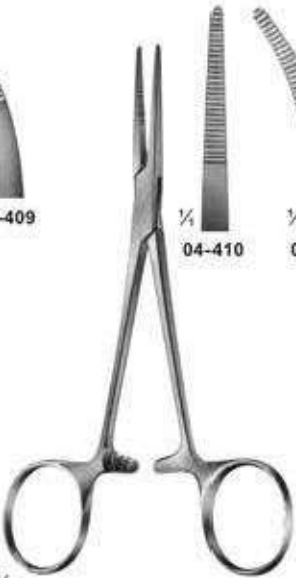

04-410 - 04-411
KELLY
140 mm

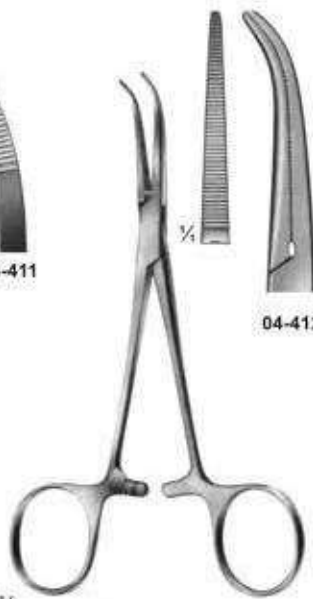

04-412 - 04-413
DANDY
Curved sideways
140 mm

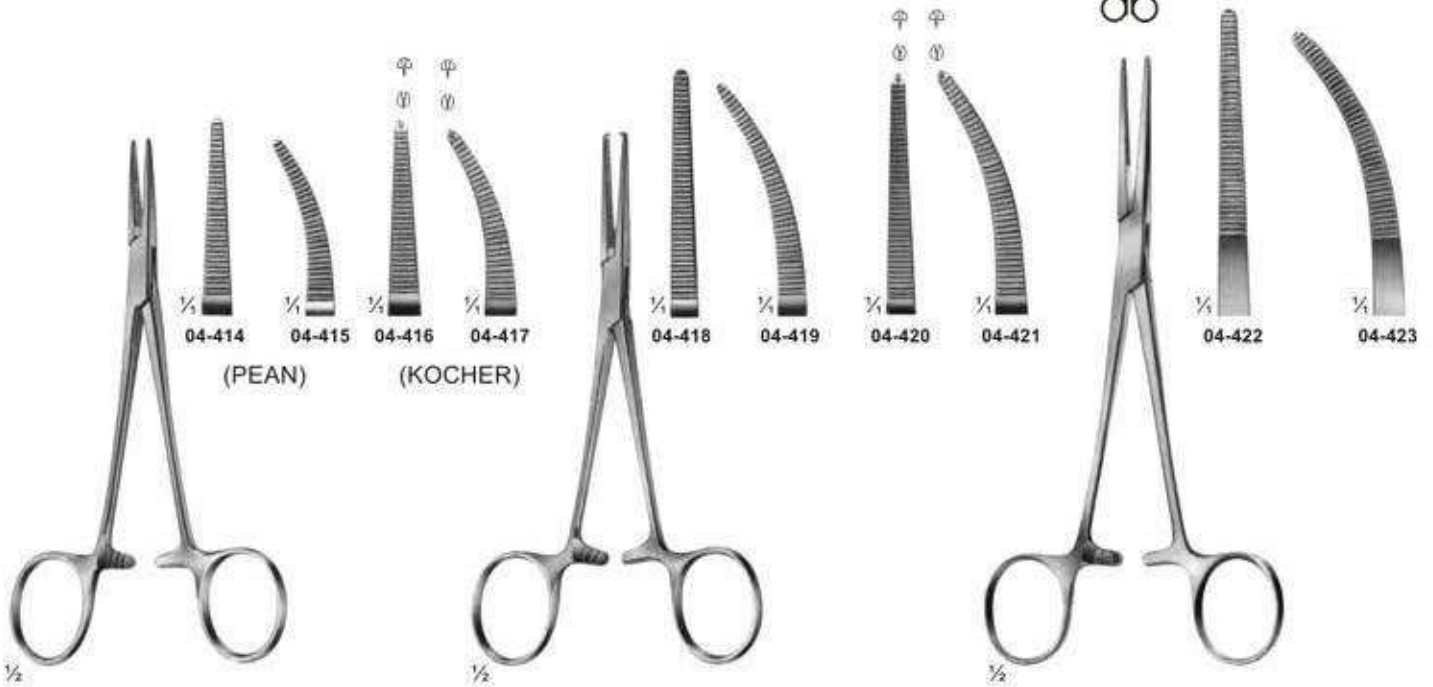

04-414 - 04-417
BABY-CRILE
140 mm

04-418 - 04-421
CRILE
140 mm

04-422 - 04-423
RANKIN
160 mm

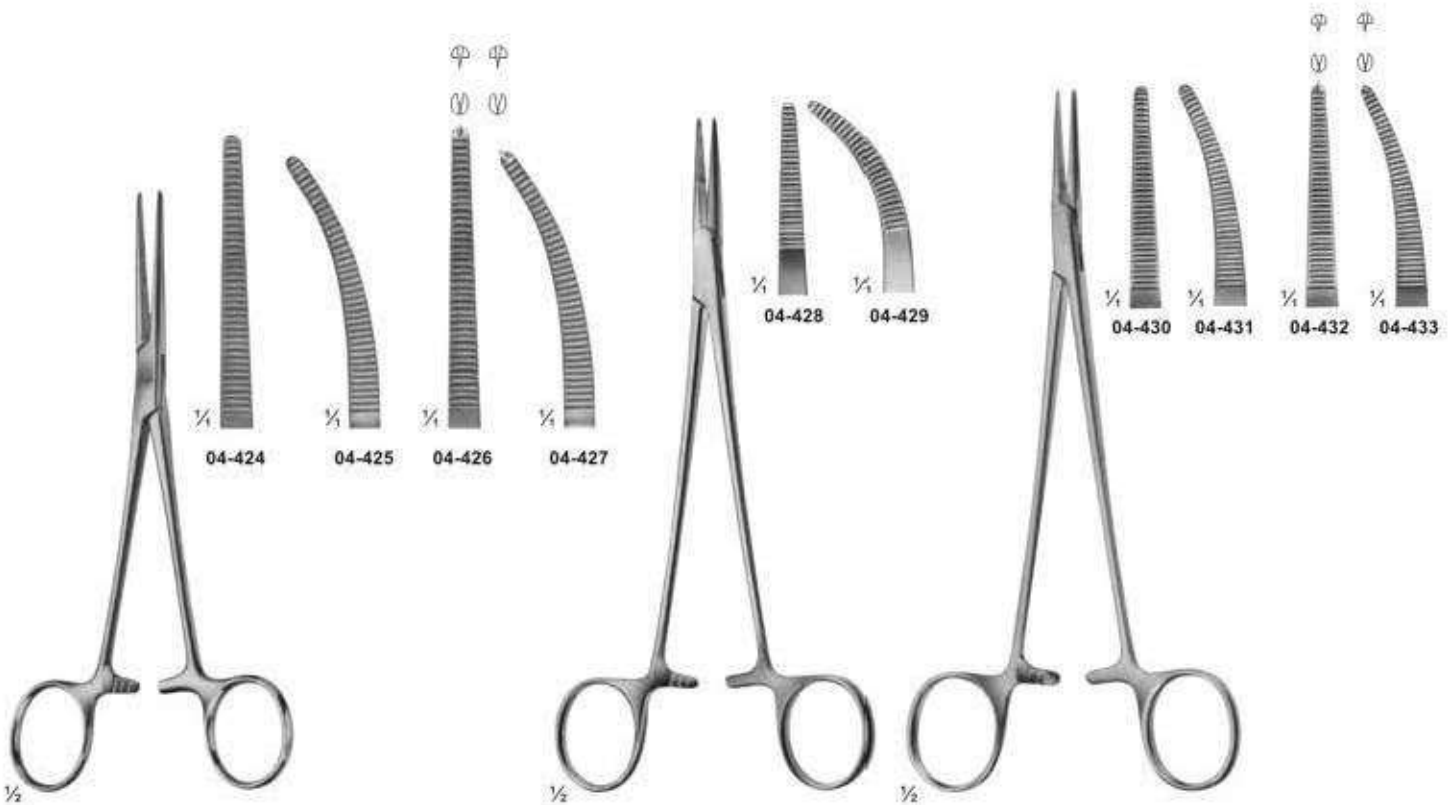

04-424 - 04-427
CRILE
160 mm

04-428 - 04-429
ADSON
185 mm

04-430 - 04-433
HALSTED
185 mm

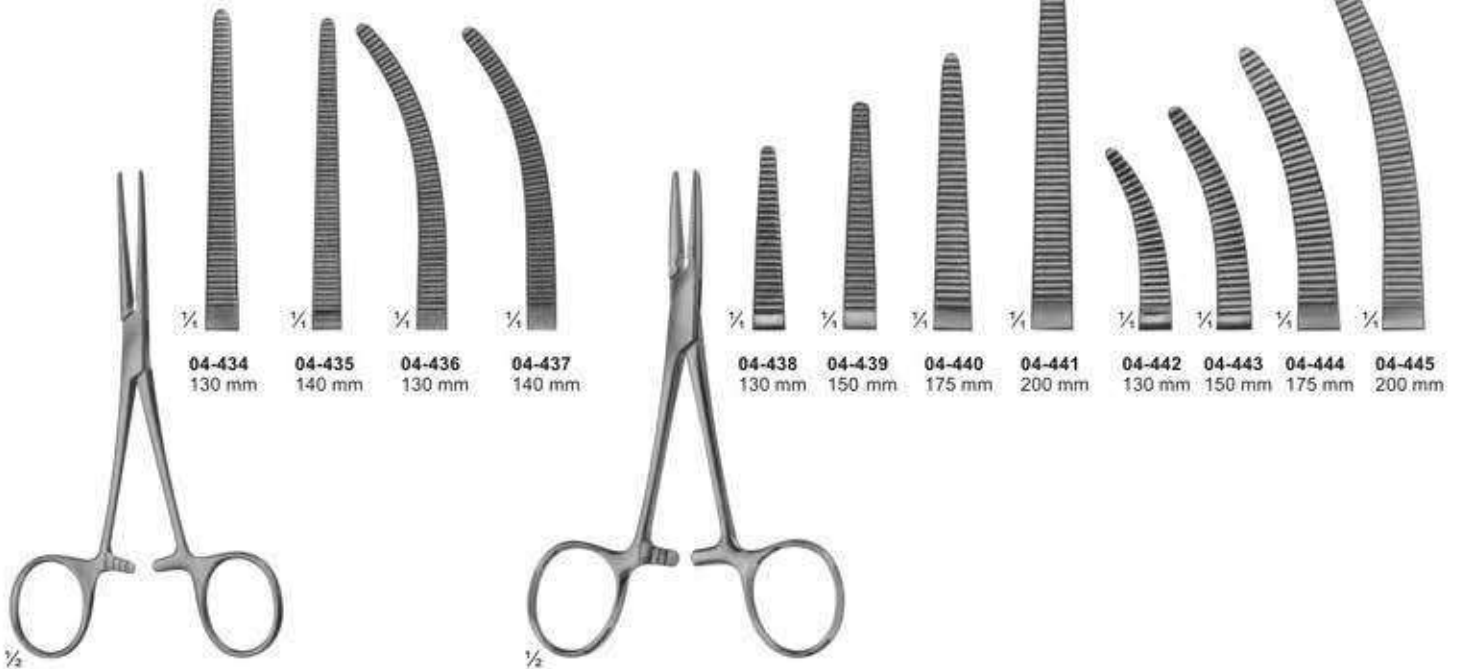

04-434 - 04-437
PEAN
Slender type

04-438 - 04-445
SPENCER-WELLS
Slender type

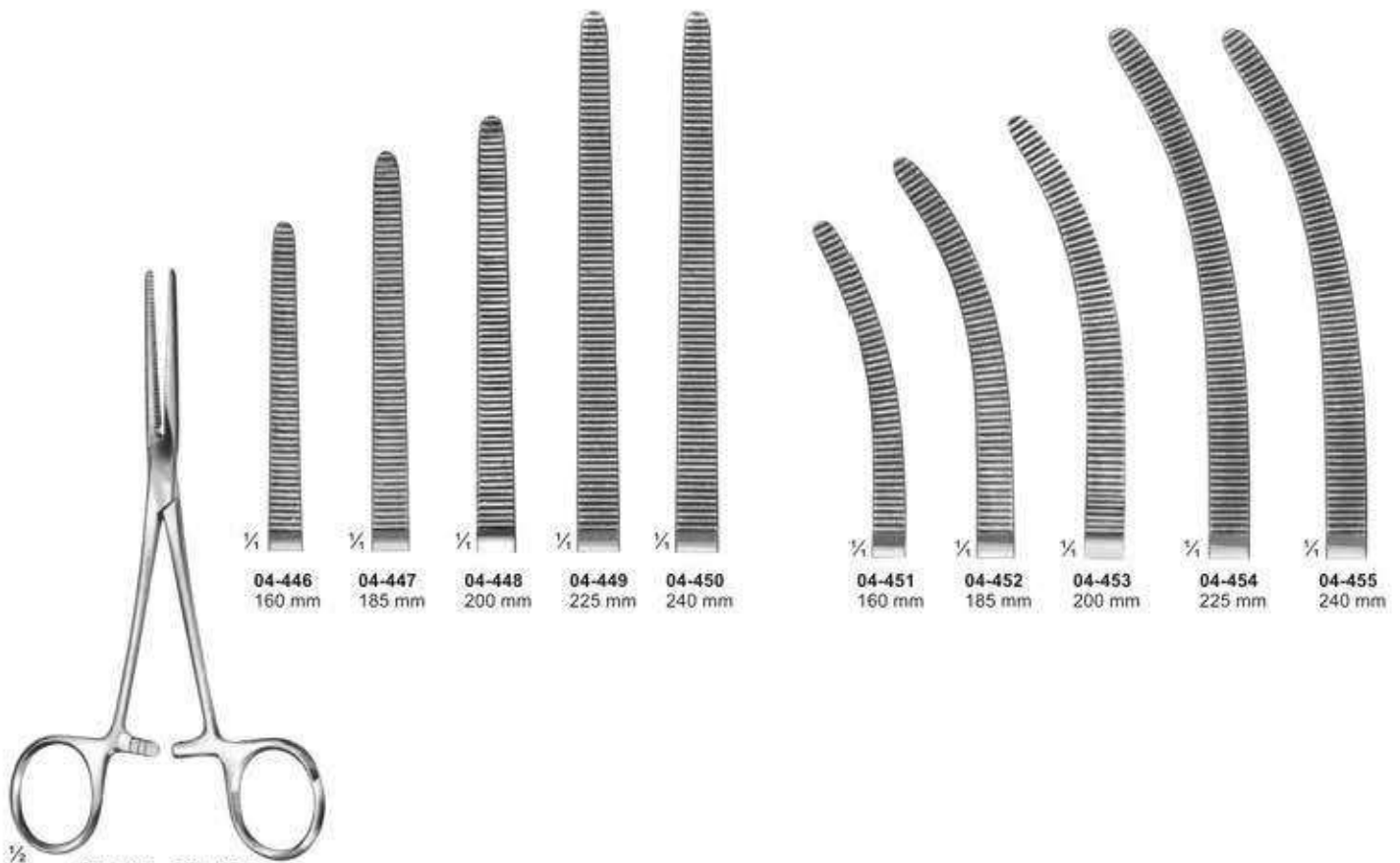

04-446 - 04-455
ROCHESTER-PEAN



04-456 - 04-461
 PEAN

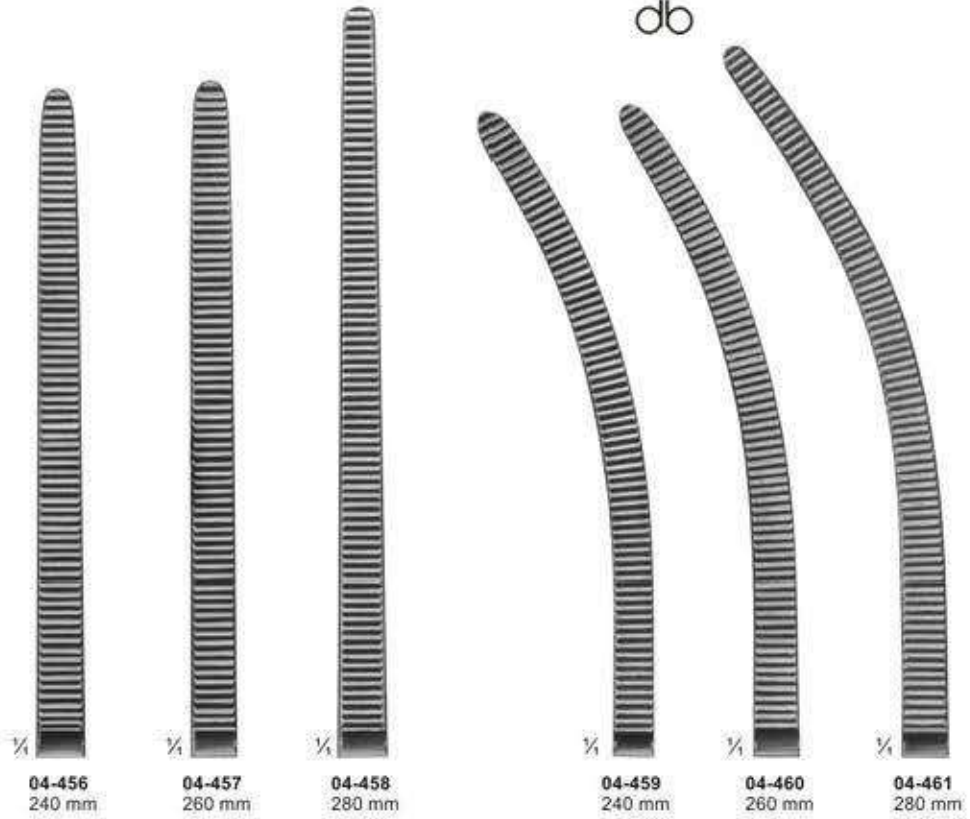

04-462
 KOCHER
 Strong Pattern
 145 mm



04-463 - 04-465
 KOCHER

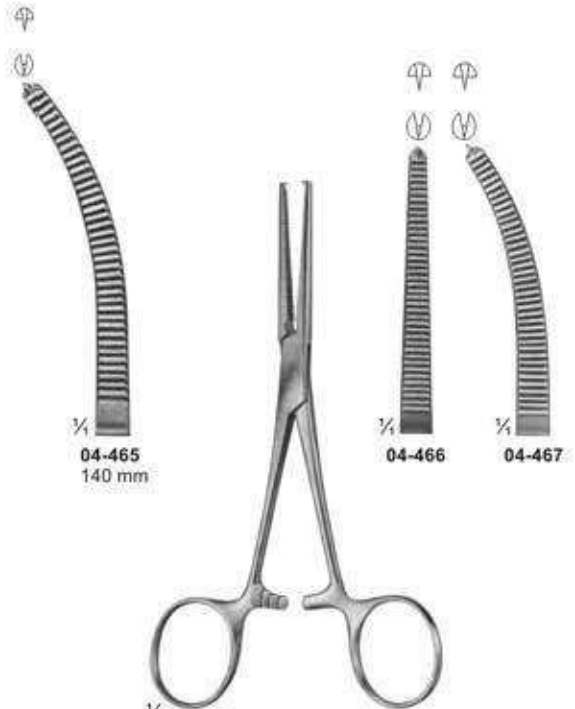

04-466 - 04-467
 ROCHESTER-OSHSNER
 140 mm

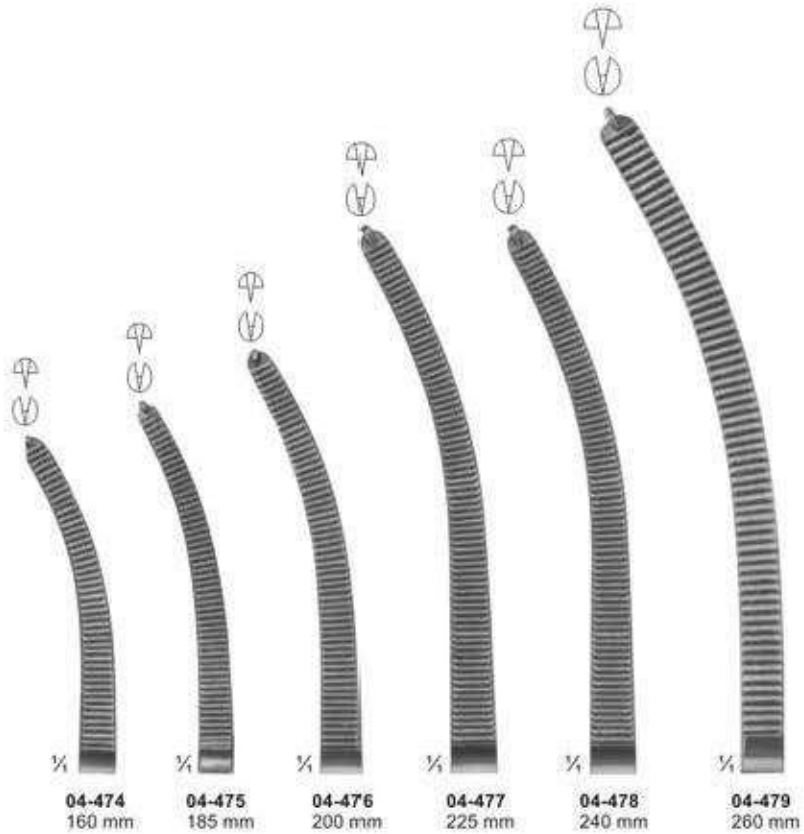
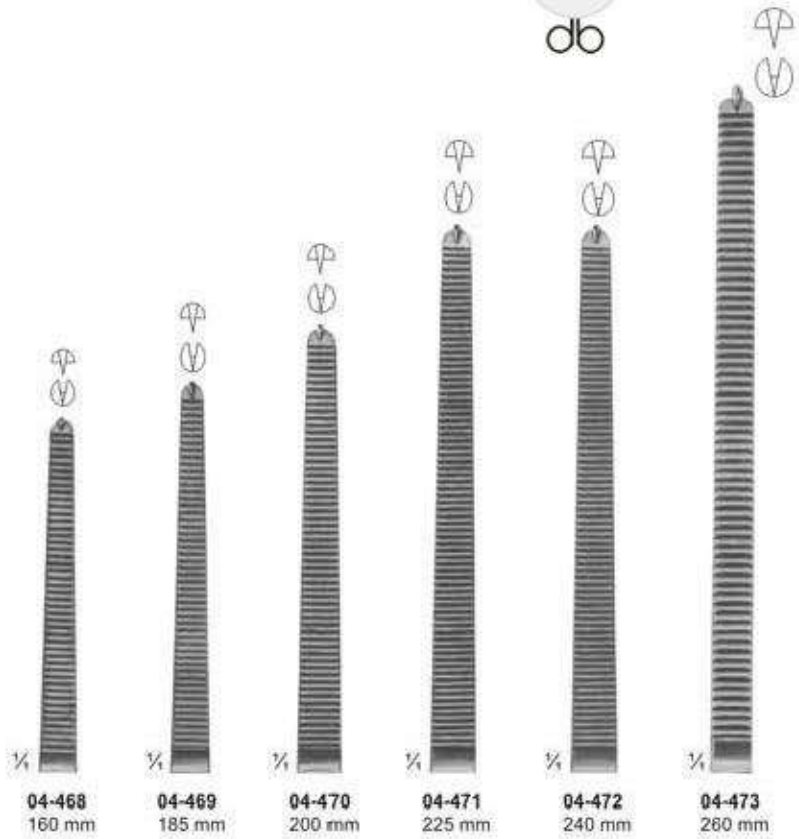

04-468 - 04-479
KOCHER-OCHSNER

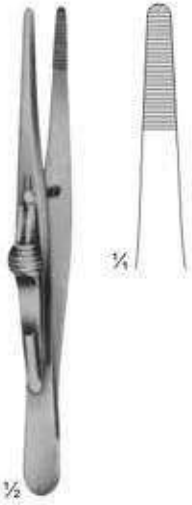

04-480
FRICKE
Artery forceps
130 mm



04-481
KRONLEIN
130 mm



04-482
PEAN
125 mm



04-483
125 mm

04-483 - 04-484
PEAN



04-484
140 mm



04-485
PEAN
125 mm



04-486
165 mm

04-486 - 04-487
PEAN



04-487
185 mm



1/2

04-488 - 04-491
ROCHESTER-CARMALT



04-488 160 mm
04-489 200 mm
04-490 160 mm
04-491 200 mm



1/2

04-492 - 04-493
MOYNIHAN



04-492 230 mm
04-493 240 mm



1/2

04-494 - 04-496
PEAN



04-494 195 mm
04-495 220 mm
04-496 230 mm



1/2

04-497 - 04-498
NEGUS
190 mm



04-497
04-498



1/2

04-499
MIKULICZ
185 mm



1/2



04-500
MIXTER-O'SHAUGNESSY
190 mm

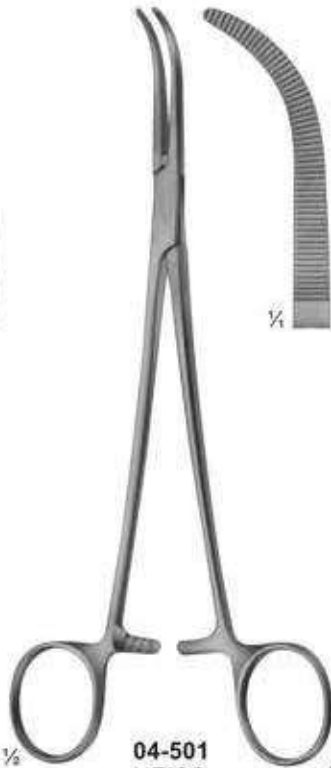

04-501
HEISS
195 mm



04-502 - 04-506
RUMEL
240 mm

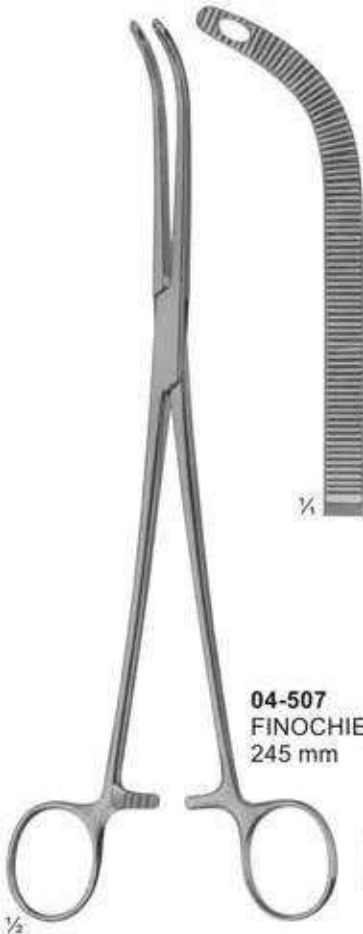
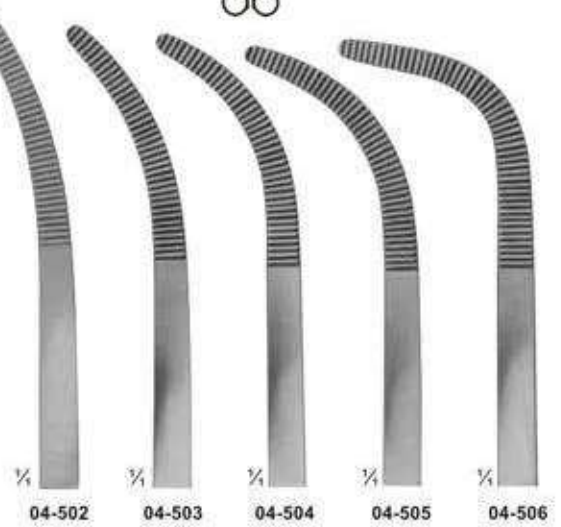

04-507
FINOCHIETTO
245 mm



04-508
MIXTER
230 mm



04-509
LAWRENCE
270 mm

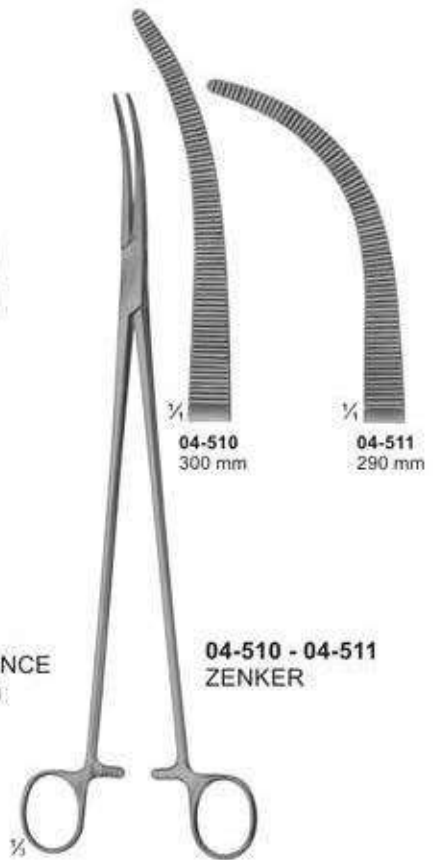

04-510
300 mm

04-511
290 mm

04-510 - 04-511
ZENKER

Hysterectomy Forceps, Vaginal Clamps and Compression Forceps



04-512
WERTHEIM
Hysterectomy forceps
255 mm

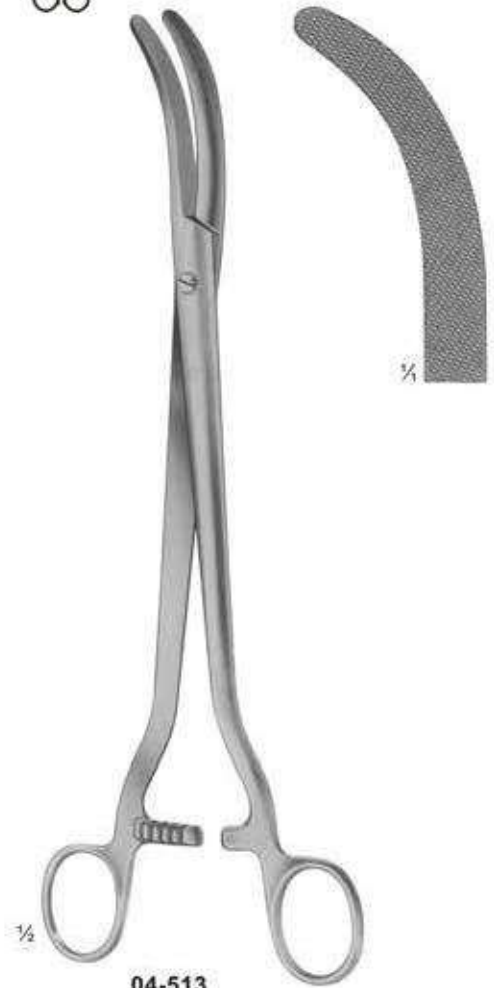

04-513
WERTHEIM
Parametrium clamp
260 mm



04-514 - 04-516
DICK



04-514 255 mm
04-515 265 mm
04-516 275 mm





05-101
ROHRSCHEIDER
with copper inserts
100 mm



05-102
KALT
with catch
135 mm



05-103
ARRUGA
with catch
135 mm



05-104 - 105
CASTROVIEJO
with catch
145 mm



05-106 - 107
without Catch
160 mm



05-108 - 109
without catch
185 mm



05-109



05-110 - 111
JACOBSON
without catch
185 mm

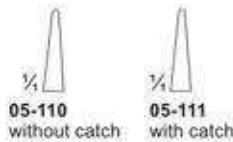

05-110
without catch



05-111
with catch



05-112
without catch
195 mm



05-113 - 114
YASARGIL
with catch
200 mm

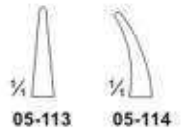

05-113

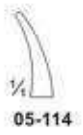

05-114



05-115
150 mm

05-116
180 mm

05-117
200 mm

05-115 - 117
MAYO-HEGAR
medium fine patterns

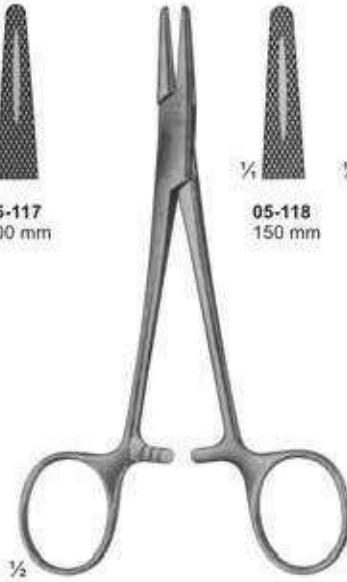

05-118
150 mm

05-119
175 mm

05-120
205 mm

05-121
205 mm

05-118 - 121
HEGAR
heavy patterns



05-122
HEANEY (HEGAR)
200 mm



05-123
JAMESON
230 mm



05-124
WANGENSTEEN
275 mm



05-125
MASSON
265 mm

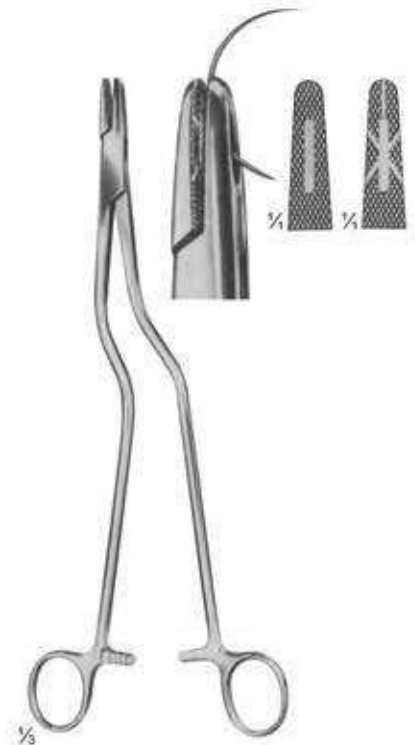

05-126
MASSON-LUETHY
255 mm

Needle Holders



05-127 - 128
HEGAR-OLSEN
255 mm

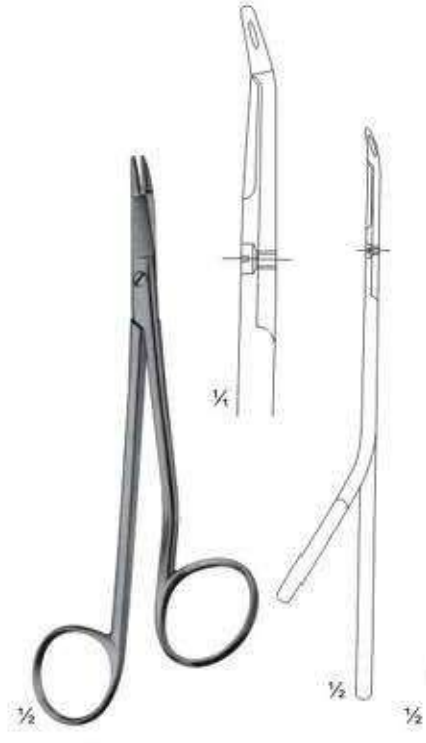

05-129
GILLIES
150 mm



05-130
GILLIES
160 mm



05-131
EISELSBERG
115 mm

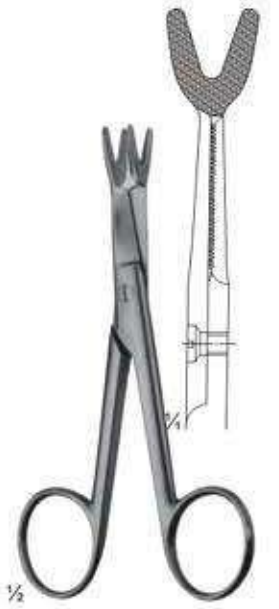

05-132
SCHOEMAKER-LOTH
125 mm



05-133
CRILE
150 mm



05-134
TOENNIS
Elastic pattern for dura-or
intestinal suture. 180 mm

Needle Holders

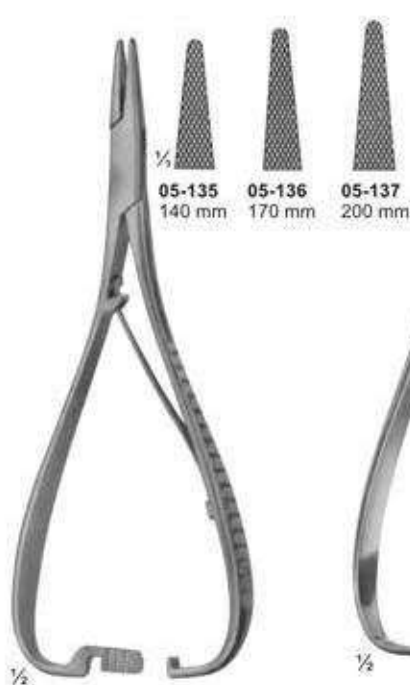

05-135 140 mm
05-136 170 mm
05-137 200 mm

05-135 - 05-137
MATHIEU

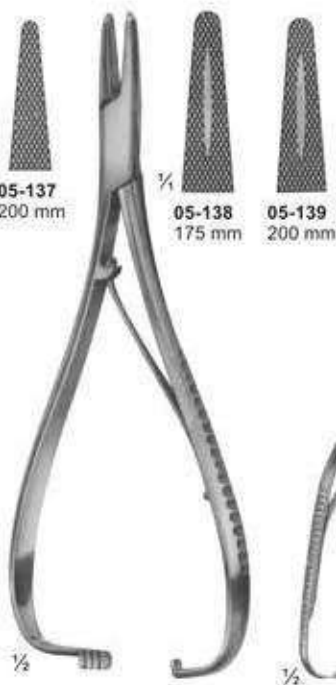

05-138 175 mm
05-139 200 mm

05-138 - 05-139
MATHIEU-STILLE
Very heavy models



05-140
BOYNTON
125 mm



05-141
EISELSBERG-MATHIEU
For palate suture
195 mm



05-142 200 mm
05-143 250 mm

05-142 - 05-143



05-144



05-145



05-146



05-147
YOUNG-
HRYNTSCHAK
With 1 needle
240 mm



05-148
YOUNG-MILLIN
With 1 needle
200 mm



05-149
MILLIN
Ligature holding
forceps. 245 mm

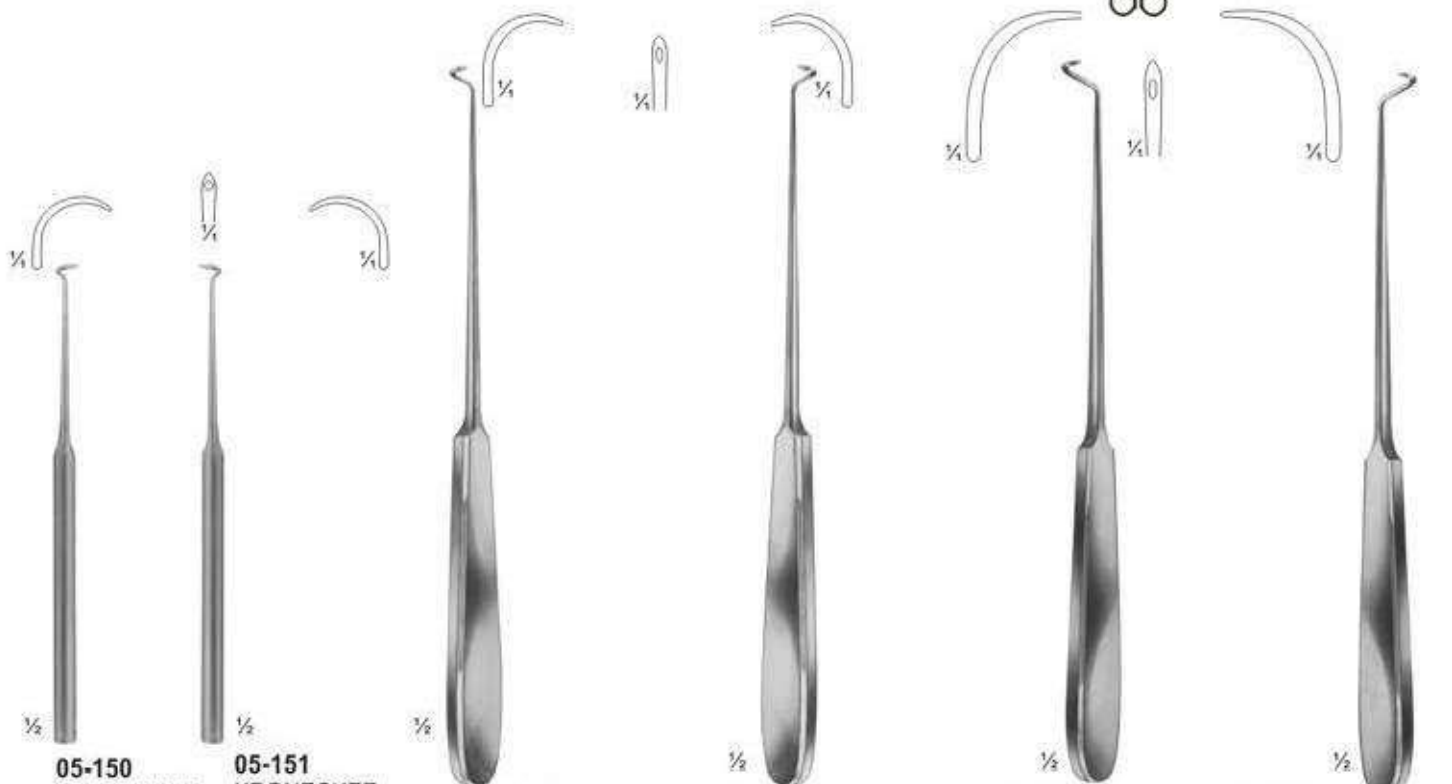

05-150
KRONECKER
for right hand
blunt
155 mm

05-151
KRONECKER
for left hand
blunt
155 mm

05-152
DESCHAMPS
for right hand
steep turn
blunt
225 mm

05-153
DESCHAMPS
for left hand
steep turn
blunt
225 mm

05-154
DESCHAMPS
for right hand
steep turn blunt
225 mm

05-155
DESCHAMPS
for left hand
steep turn blunt
225 mm

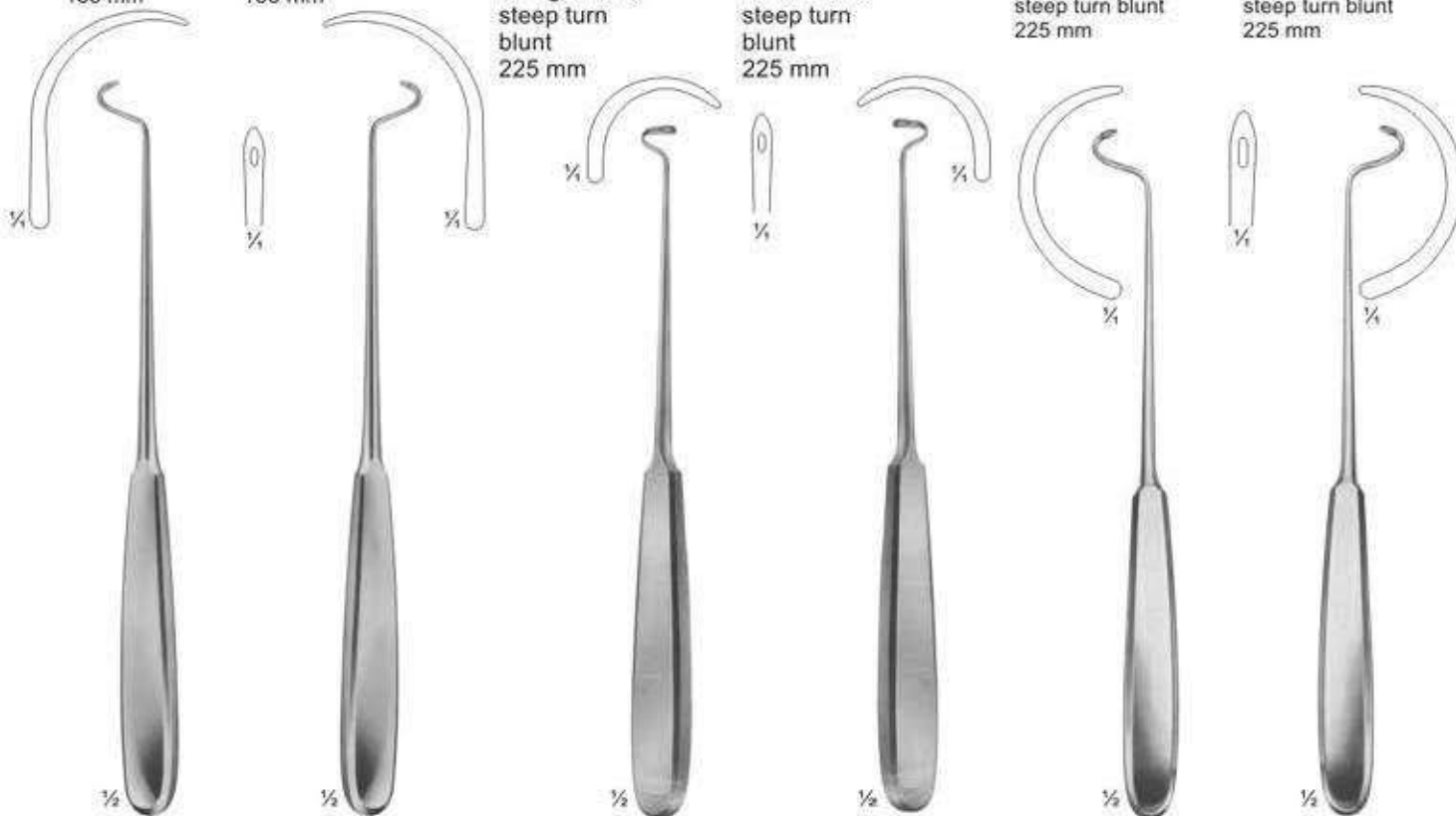

05-156
DESCHAMPS
for right hand
steep turn blunt
230 mm

05-157
DESCHAMPS
for left hand
steep turn blunt
230 mm

05-158
DESCHAMPS
for right hand blunt
215 mm

05-159
DESCHAMPS
for left hand blunt
215 mm

05-160
DESCHAMPS
for right hand blunt
210 mm

05-161
DESCHAMPS
for left hand
blunt. 210 mm



05-162 130 mm
05-163 145 mm
05-164 160 mm
Directors



05-165
DOYEN
145 mm
Directors



05-166
NELATON
160 mm
Directors



05-167
Director with tip
Diam. Of tip 3,3 mm
140 mm



05-168
BRODIE
Director with tip,
Diam. Of tip 3,5 mm
200 mm

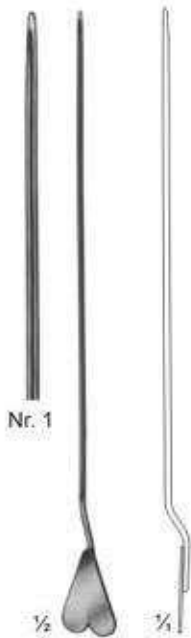

05-169
LOCKHART-MUMMERY
165 mm



05-170
LOCKHART-MUMMERY
165 mm

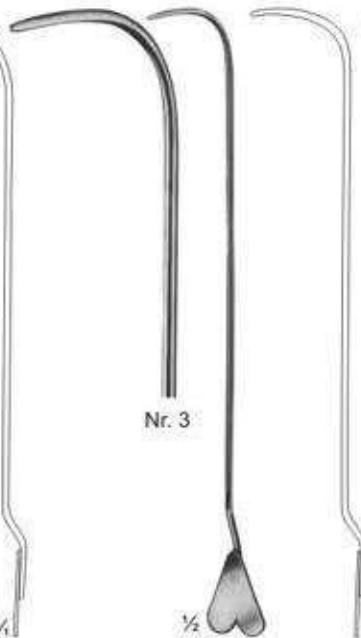

05-171
LOCKHART-MUMMERY
165 mm

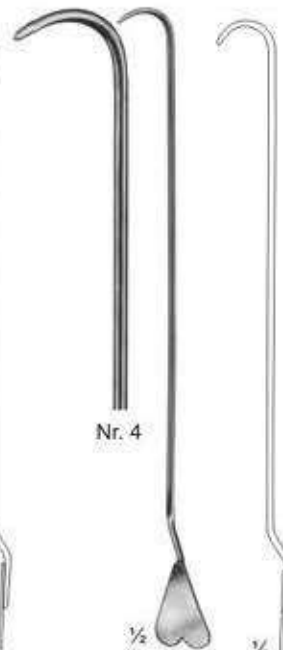

05-172
LOCKHART-MUMMERY
165 mm



05-173
Director with wire
loop, malleable
190 mm



05-174 145 mm
05-175 160 mm
05-176 200 mm
Probes with eye



05-177
Myrtle leaf probe
145 mm



05-178 130 mm
05-179 145 mm
05-180 160 mm
05-181 180 mm
05-182 200 mm



05-183
Probes



05-184 $\frac{1}{2}$
Double ended probe,
malleable, diam. of tips
3 mm with hole
190 mm



05-185
Double ended probes,
tin, malleable,
diam. of tips
3,5 mm with hole
250 mm, 300 mm



05-186 $\frac{1}{4}$
Double ended probes,
tin, malleable,
diam. of tips 4 mm
400 mm



$\frac{1}{2}$ \varnothing tip
05-187 1,5 mm
05-188 2,0 mm
05-189 2,5 mm
300 mm



05-190

Suturing instruments set, in metal case consisting of: Scissors, curved, sharp/sharp, 115mm
25 MICHEL clip, 16 x 3mm
1 Delicate tissue forceps, 130mm
1 Scalpel, bellied
1 MATHIEU needle holder, 140mm
1 Perforated metal case, stainless containing:
1 Suture needle
1 item 1 item



05-191

Pocket instrument set, in metal case consisting of:

Bottom tray

1 MATHIEU needle holder, 140mm
1 MICHEL clip forceps, combined
1 Myrtle leaf probe, 130mm
1 Sharp double curette
1 Skin hook
1 Detachable scalpel handle, no.4
1 Perforated metal case, containing
6 Scalpel blades
1 Perforated metal case, stainless, containing
1 Suture needle
1 item
1 item

Top tray

1 Tissue forceps, 130mm
1 KOCHER haemostatic forceps, 130mm
1 Straight surgical scissors, 130mm
1 Dissecting forceps, 130mm
1 FEILCHENFELD splinter forceps, 115mm
25 MICHEL clip, 16 x 3mm
1 Flacon of suture skin, sterile in alcohol



05-192

Pocket instrument set, in metal case consisting of:

Bottom tray

1 MAYO-HEGER needle holder, 150mm
1 MICHEL clip forceps, combined
1 Myrtle leaf probe, 130mm
1 Sharp double curette
1 Skin hook
1 Detachable scalpel handle, no. 4
1 Perforated metal case, consisting
6 Scalpel blades
1 Perforated metal case, stainless, consisting:
1 Suture needle
1 item, & 1 item

Top tray

1 Tissue forceps, 130mm
1 CRILE haemostatic forceps, 140mm
1 Straight surgical scissors, 130mm
1 Dissecting forceps, 130mm
1 FEILCHENFELD splinter forceps, 115mm
25 MICHEL clip, 16 x 3mm
1 Flacon of suture silk, sterile in alcohol

Fine Wound Retractors (Dura- and Skin Retractors)



06-101 Sharp
06-102 Blunt
GRAEFE
125 mm



06-103 125 mm
06-104 130 mm
sharp
GUTHRIE



06-105 130 mm
06-106 135 mm
sharp
ROLLET
06-107 135 mm
blunt



06-108
FRAZIER
Dura retractors
130 mm



06-109
TONNIS
Dura retractors
150 mm



06-110
KILNER
160 mm



06-111
FREER
150 mm



06-112
MULLER
150 mm



06-113
MULLER
150 mm



06-114
COTTLE
160 mm



06-115
COTTLE
160 mm



06-116
JAEGER
135 mm



06-117 - 120
JOSEPH
165 mm



06-117 - 122
GILLIES
180 mm



06-123
KILNER
sharp
80 mm



06-124
CONVERSE
blunt
120 mm

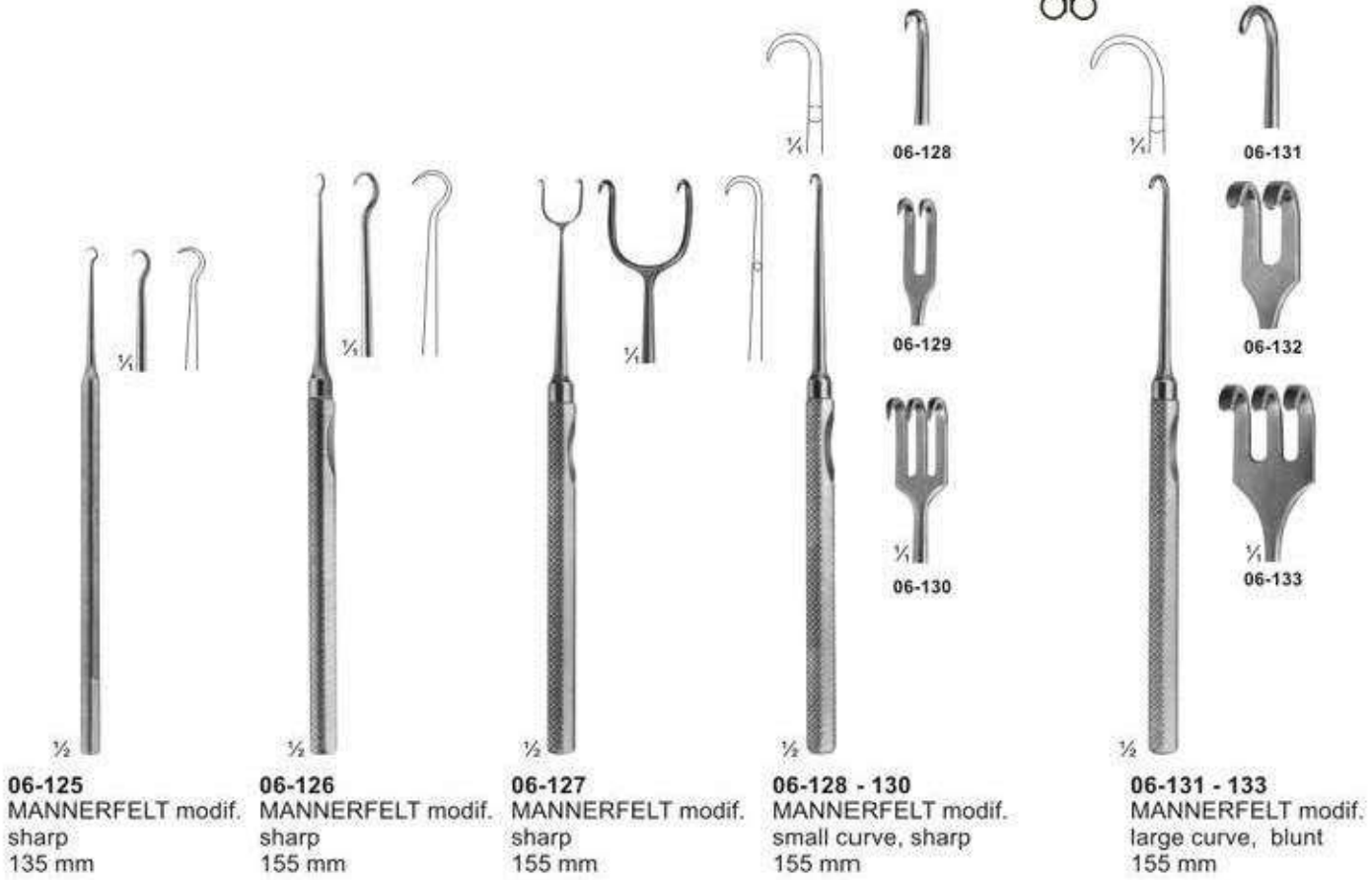



1/4
6 x 12 mm

1/2
06-142
MASING
140 mm



1/4
10 x 12 mm

1/2
06-143
COTTLE
140 mm



06-144
9 x 9 mm



06-145
9 x 12 mm

1/2
06-144 - 148
DESMARRES
140 mm



1/4
06-146
11 x 14 mm



06-147
12 x 16 mm



1/4
06-148
13 x 18 mm



1/4
06-149
13 x 13 mm



1/4
10 x 10 mm



1/4
06-150
12 x 16 mm

1/2
06-149 - 150
KONIG
180 mm

1/2
06-151
CUSHING-KOCHER
175 mm



1/2
06-152 - 153
KOCHER
205 mm



1/4
06-152
20 x 12 mm



1/4
06-153
20 x 15 mm



1/2
06-154
SCHOENBORN
200 mm



1/4
13 x 6 mm



1/2
06-155 - 156
CUSHING
205 mm



1/4
06-155
10 x 13 mm

1/4
06-156
14 x 18 mm



1/2
06-157
205 mm

20 x 15 mm

20 x 19 mm



1/2
06-158 - 160
CUSHING
250 mm



1/4
06-158
11 x 14 mm



1/4
06-159
13 x 18 mm



1/4
06-160
15 x 22 mm

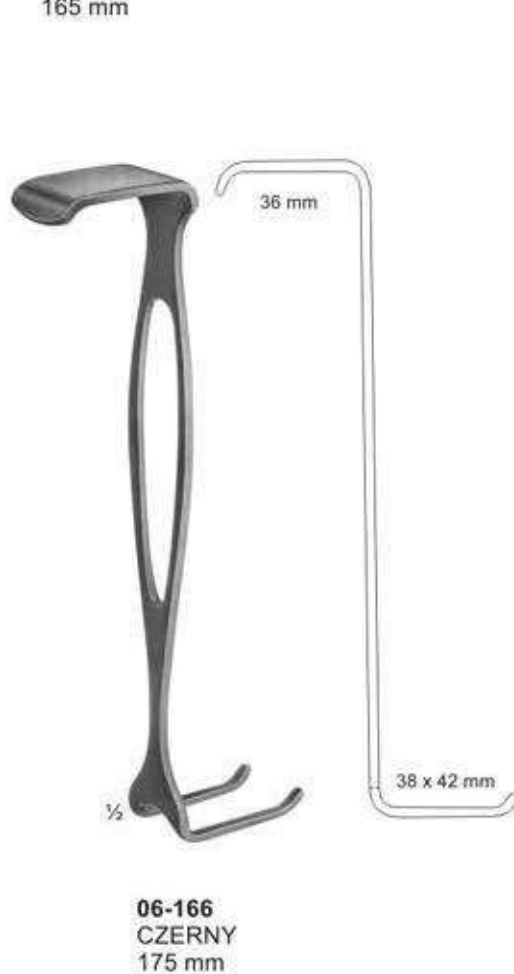
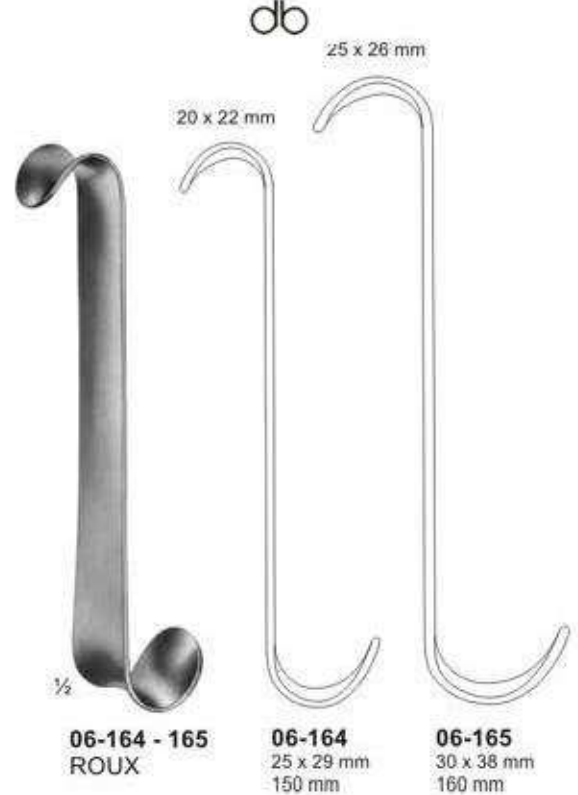

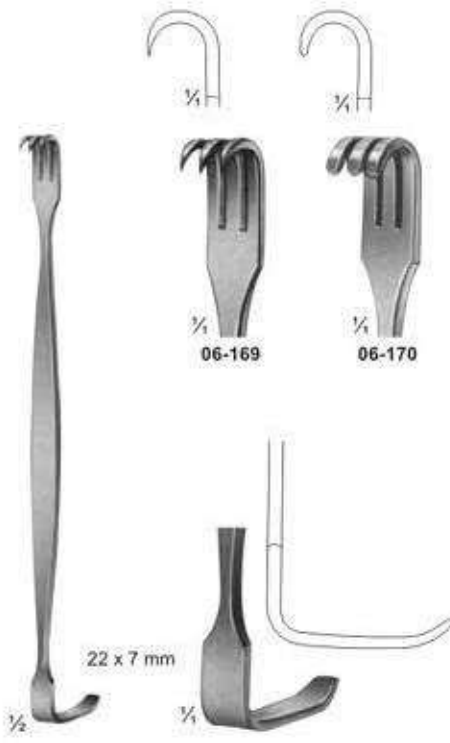

06-169 - 06-170
BABY-SENN-MILLER
 155 mm



06-171
SENN-MILLER
 165 mm



06-172
COLLIN-HARTMANN
 150 mm

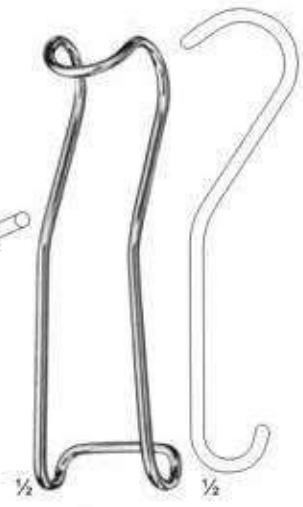

STERBERG
06-173 120 mm
06-174 130 mm
06-175 135 mm
06-176 140 mm



06-177
LUER
 110 mm

06-178
ROSE
 130 mm

06-179
BABY-ROUX
 135 mm



06-180
PARKER
 135 mm

06-181
CRILE
 110 mm



06-182
FARABEUF
 150 mm

06-183
COLLIN
 150 mm



06-182
FARABEUF
 150 mm

06-183
COLLIN
 150 mm



06-184
KOCHER
sharp
205 mm



06-185
KOCHER
sharp
220 mm



06-186
KOCHER
sharp
220 mm



06-187
VOLKMANN
blunt
220 mm



06-188
VOLKMANN
sharp
220 mm



06-189 - 06-196
VOLKMANN
225 mm



Sharp

1/2



06-189
9 x 8 mm



06-190
9 x 13 mm



06-191
9 x 19 mm



06-192
9 x 29 mm



Blunt

1/2



06-193
8,5 x 8 mm



06-194
8,5 x 13 mm



06-195
8,5 x 19 mm



06-196
8,5 x 29 mm

Retractors



1/2
06-197
15 x 15 mm
220 mm



1/2
06-198
20 x 22 mm
215 mm

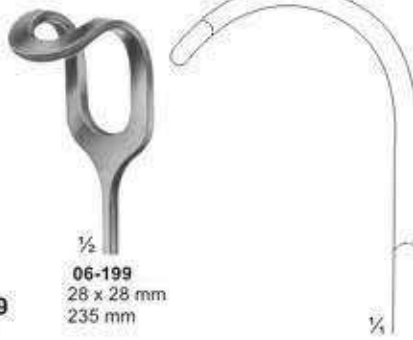

1/2
06-199
28 x 28 mm
235 mm

1/2
06-197 - 06-199
MIDDELDORPF



38 x 18 mm

1/2
06-200
BUCHS
205 mm



67 x 17 mm

1/2
06-201
CASPAR
210 mm



36 x 20 mm

1/2
06-202
KOCHER
230 mm



06-203-06-209
BRUNNER
275 mm

- 06-203 80 x 20
- 06-204 100 x 25
- 06-205 120 x 25
- 06-206 130 x 30
- 06-207 140 x 30
- 06-208 160 x 30
- 06-209 180 x 30



06-210
Handle with cold
light carrier for
retractor blades.
280 mm



Handle arrange-
ment verriable



Retractors for deep surgery (Abdominal Retractors)



06-216
MIKULICZ
255 mm

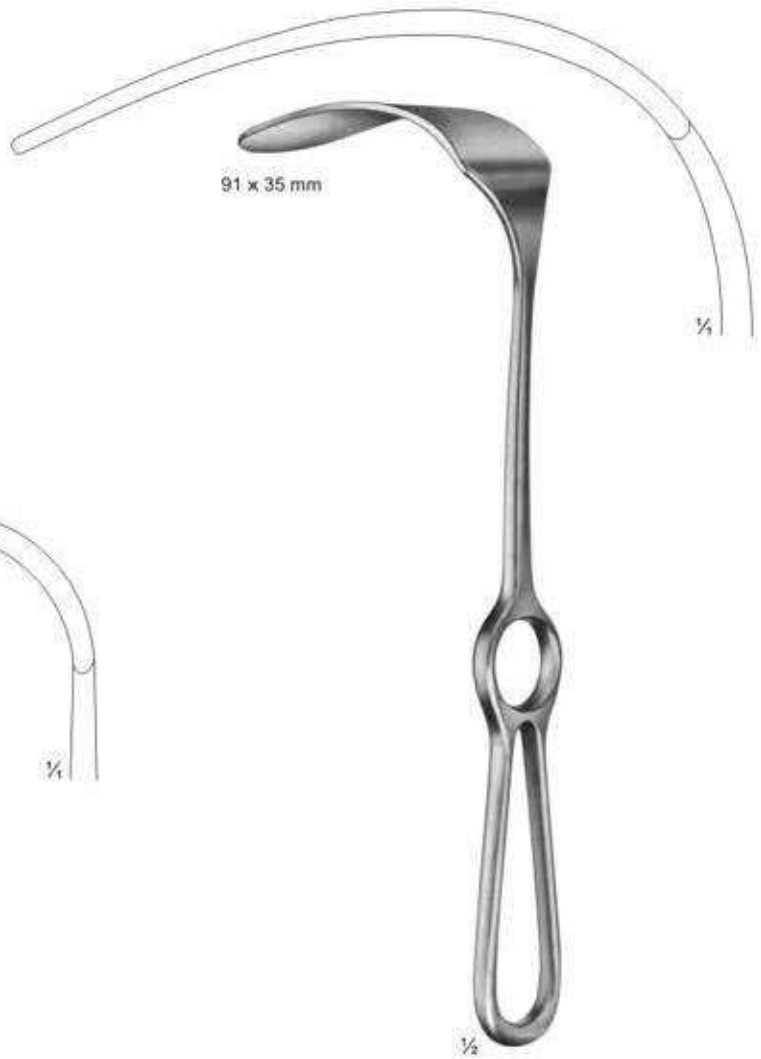

06-217
MIKULICZ
250 mm

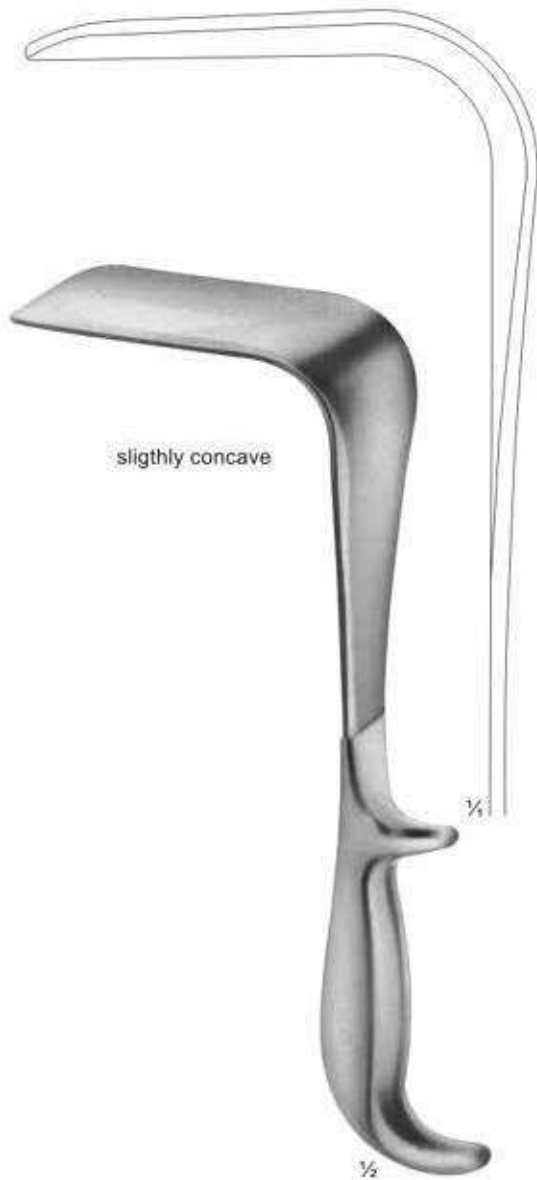

06-218 - 06-228
DOYEN
240 mm



06-229 - 06-233
FRITSCH
240 mm



06-234
DOYEN
250 mm

- 06-229 Fig.1 32 x 40 mm
- 06-230 Fig.2 34 x 50 mm
- 06-231 Fig.3 41 x 60 mm
- 06-232 Fig.4 46 x 75 mm
- 06-233 Fig.5 64 x 85 mm

	width of blades	
	35 mm, 45 mm, 60 mm	
length of blades		
62 mm	06-218, 06-222, 06-226	
92 mm	06-219, 06-223, 06-227	
122 mm	06-220, 06-224, 06-228	
160 mm	06-221, 06-225	

Abdominal- and Intestinal Spatulas Bauch- und Darmspatel



06-235
LERICHE
255 mm

06-236
KUMMEL
Mealleable
285 mm

06-237
MIKULICZ
29 mm
250 mm

06-238 - 06-239
KADER
06-238 30 mm
06-239 40 mm
270 mm



06-240
WEITLANER
sharp
130 mm

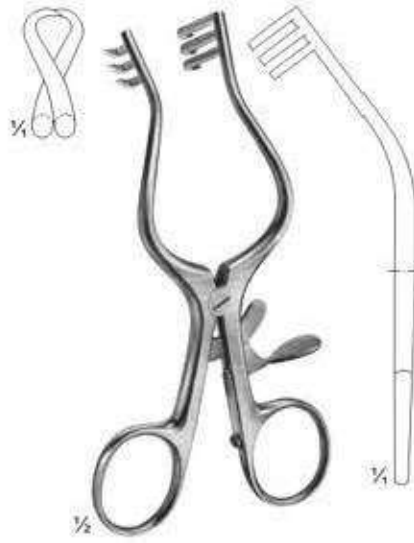

06-241
WULLSTEIN
sharp
130 mm

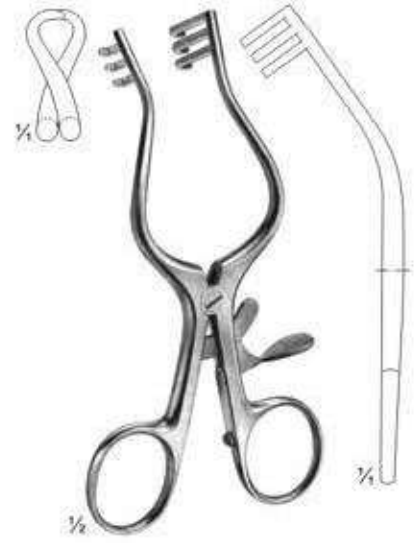

06-242
WULLSTEIN
blunt
130 mm



06-243
WEITLANER
sharp
165 mm



06-244
PLESTER
blunt
110 mm



06-245
PERKINS
blunt
130 mm



06-246
JOLL (FRIEDMAN)
 Thyroid- and vaginal retractor
 155 mm

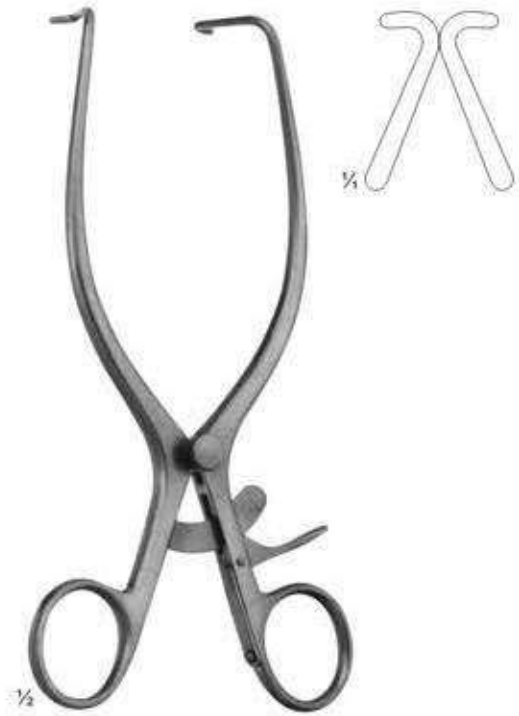

06-247
JACKSON BURROWS
 Retractor, blunt
 185 mm

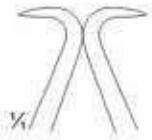

06-248
GELPI
 Vaginal retractor
 135 mm



06-249
GELPI
 Skin- and vaginal retractor
 175 mm

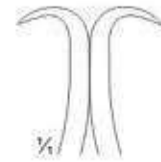

06-250
DE BAKEY
 Femur retractor
 145 mm



06-251
CLOWARD
155 mm



06-252
CLOWARD
135 mm



06-253
INGE
170 mm

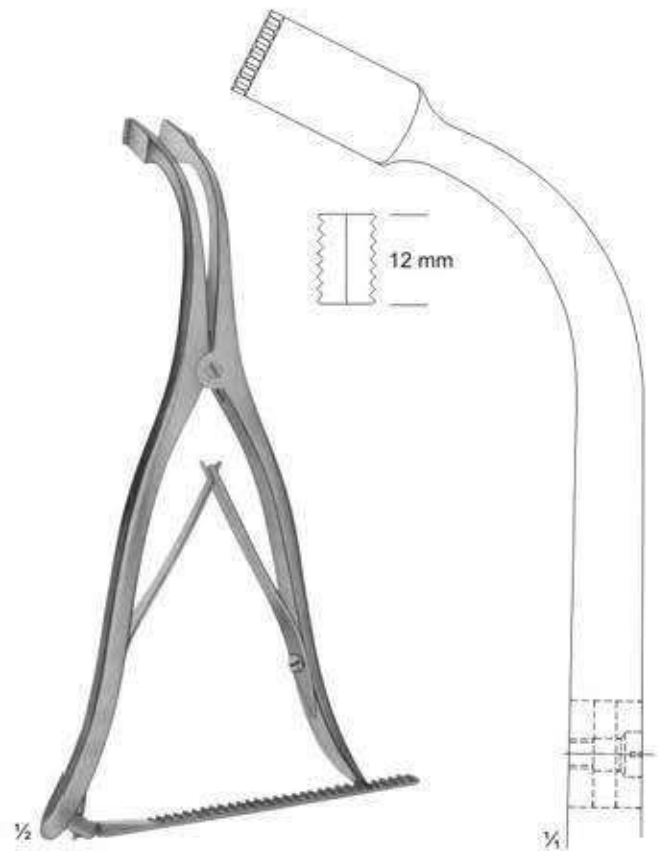

06-254
INGE
275 mm



06-255
GOSSET
Blades: 38 mm deep

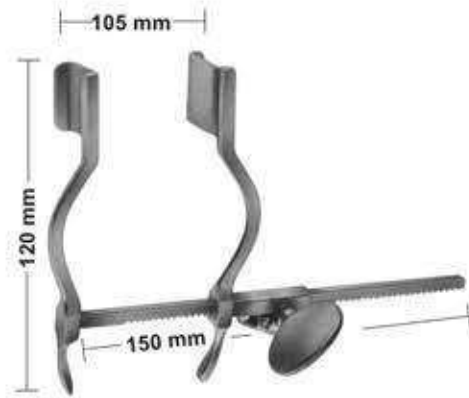

06-256
HERTZLER
Blades 20 X 25 mm

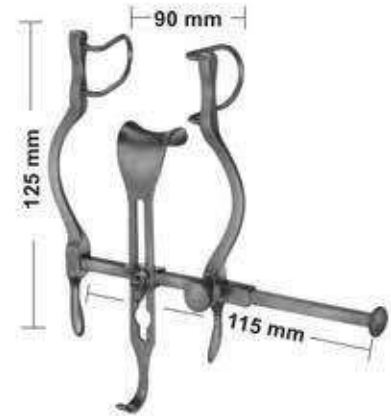

06-257
BALFOUR-BABY
Lateral blades 27 mm deep
Center blade 21x24 mm

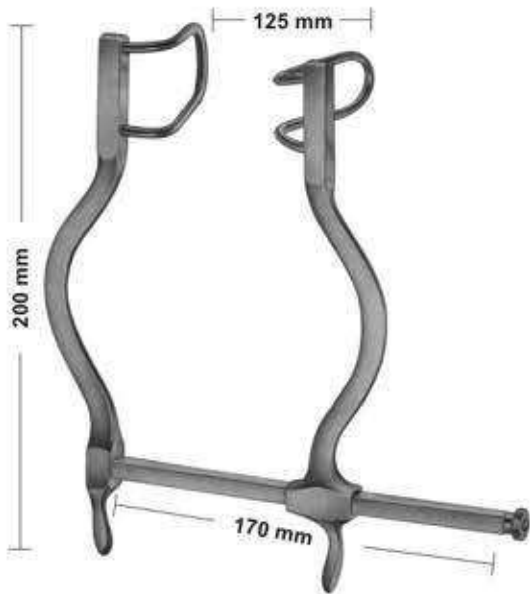

06-258
GOSSET
Blades: 55mm deep

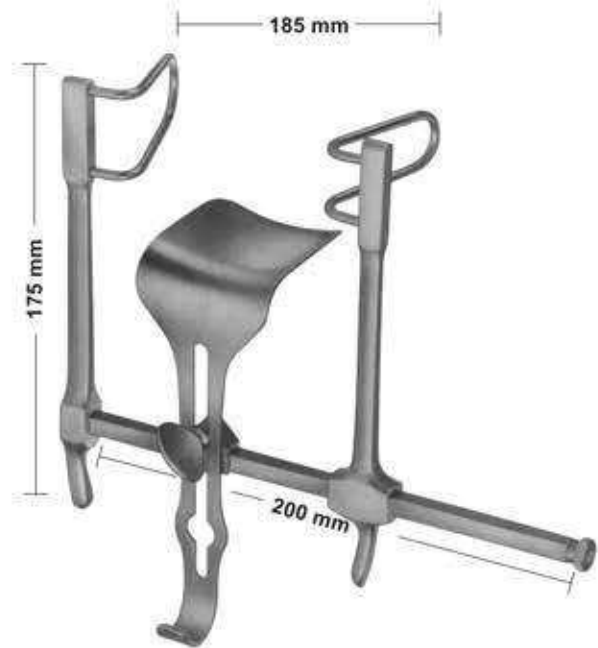

06-259
GOSSET
Lateral blades 58 mm deep
Center blade 59 x 57 mm

Abdominal Retractors

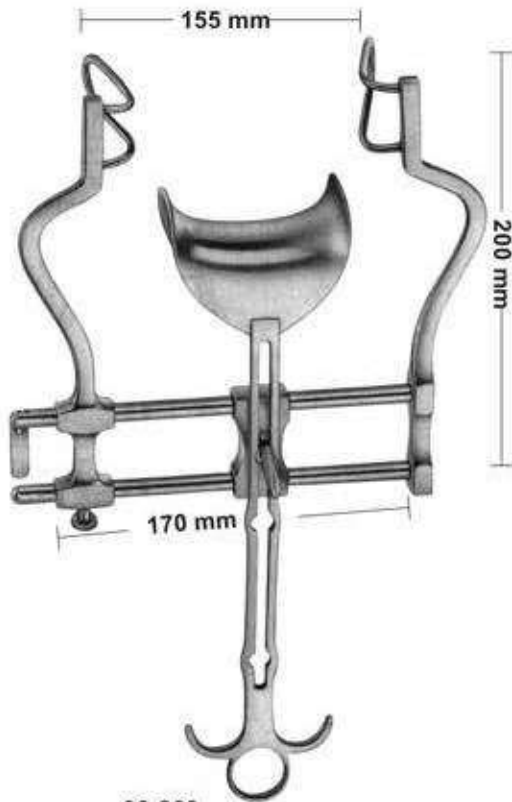

06-260
BALFOUR
Lateral blades 60 mm deep
Center blade 47 x 80 mm

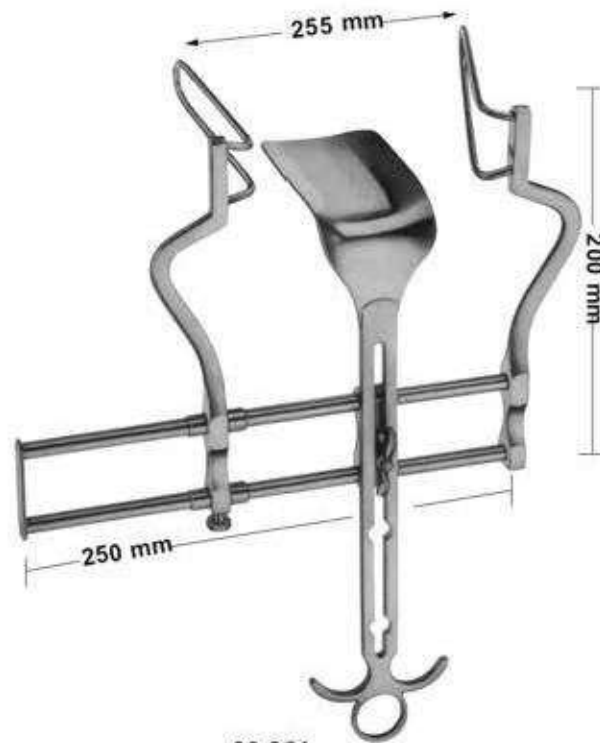

06-261
BALFOUR
Lateral blades 105 mm deep
Center blade 107x 59 mm



06-262
Center blade only
54x80 mm

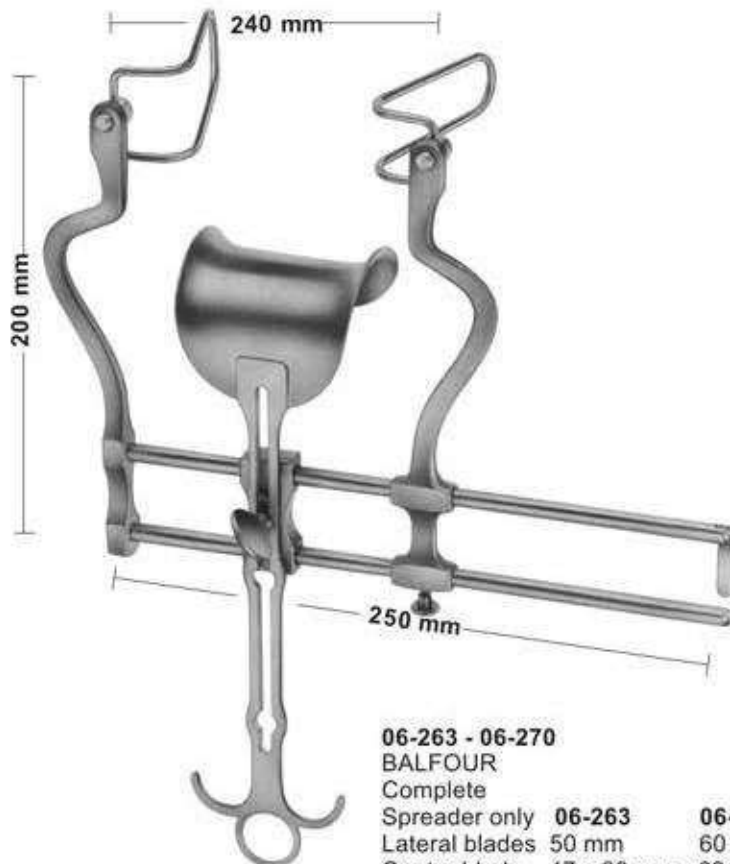

06-263 - 06-270
BALFOUR
Complete

	06-263	06-264	06-265	06-266
Spreader only				
Lateral blades	50 mm	60 mm	75 mm	90 mm
Center blade	47 x 80 mm	62x76 mm	80x80 mm	80x80 mm



Lateral blades
06-267 50 mm deep
06-268 60 mm deep
06-269 75 mm deep
06-270 90 mm deep
Sales Unit of blades: PR = pair

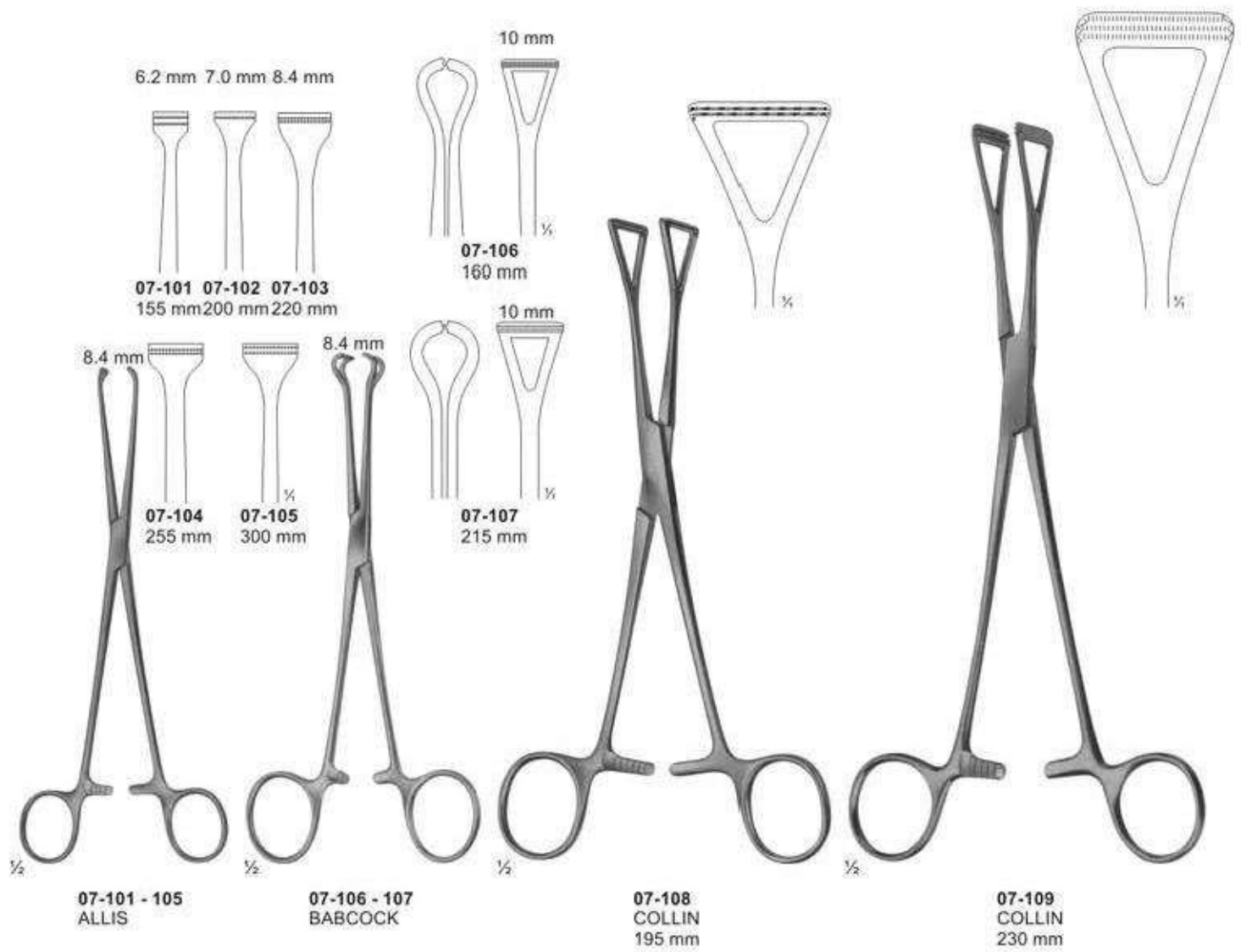

Intestinal Clamps, soft elastic

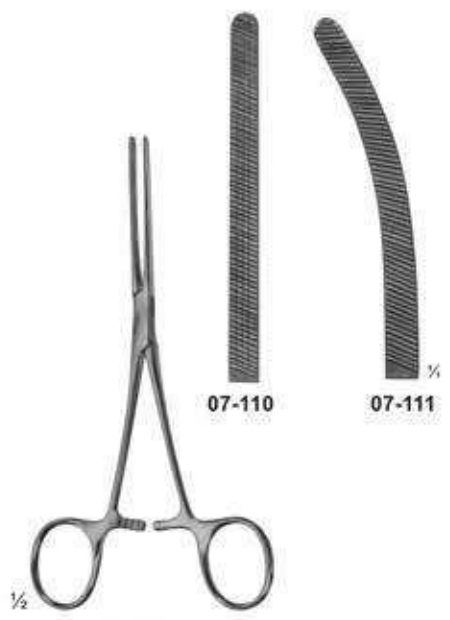

07-110 - 111
DOYEN
 elastic
 165 mm

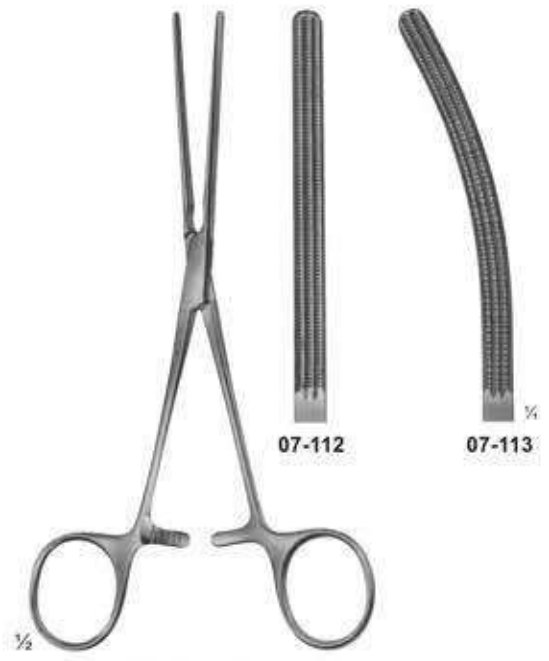

07-112 - 113
DOYEN
 with elastic blades
 170 mm

ATRAUMATA

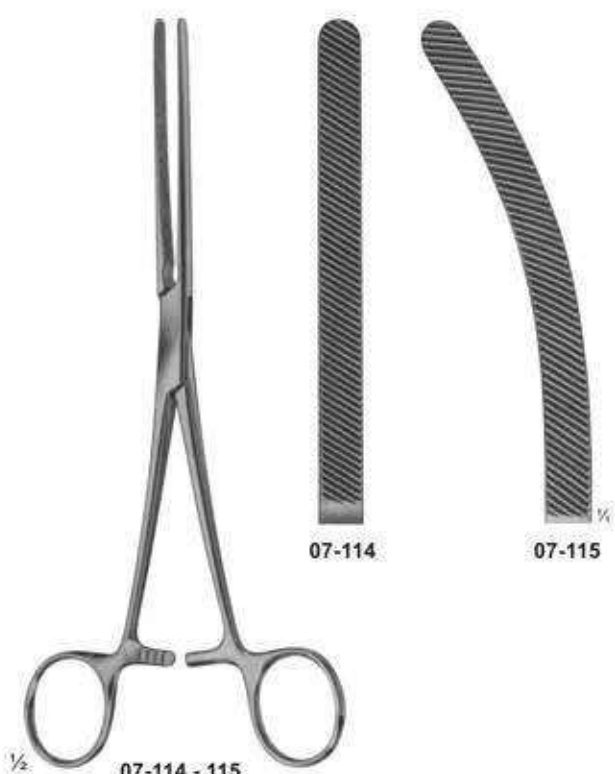

07-114 - 115
HARTMANN
 with elastic blades
 200 mm

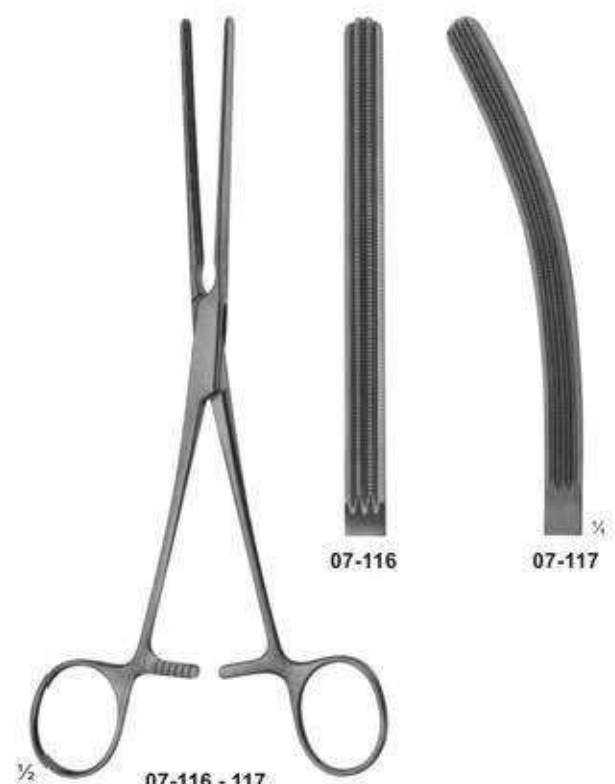

07-116 - 117
HARTMANN
 with elastic blades
 200 mm



07-118
PAYR
Intestinal clamp
light pattern,
for children
180 mm

07-119
PAYR
200 mm

07-120
PAYR
275 mm

07-121
PAYR
Pylorus clamp
315 mm

ATRAUMATA
Sigmoid Anastomosis Forceps

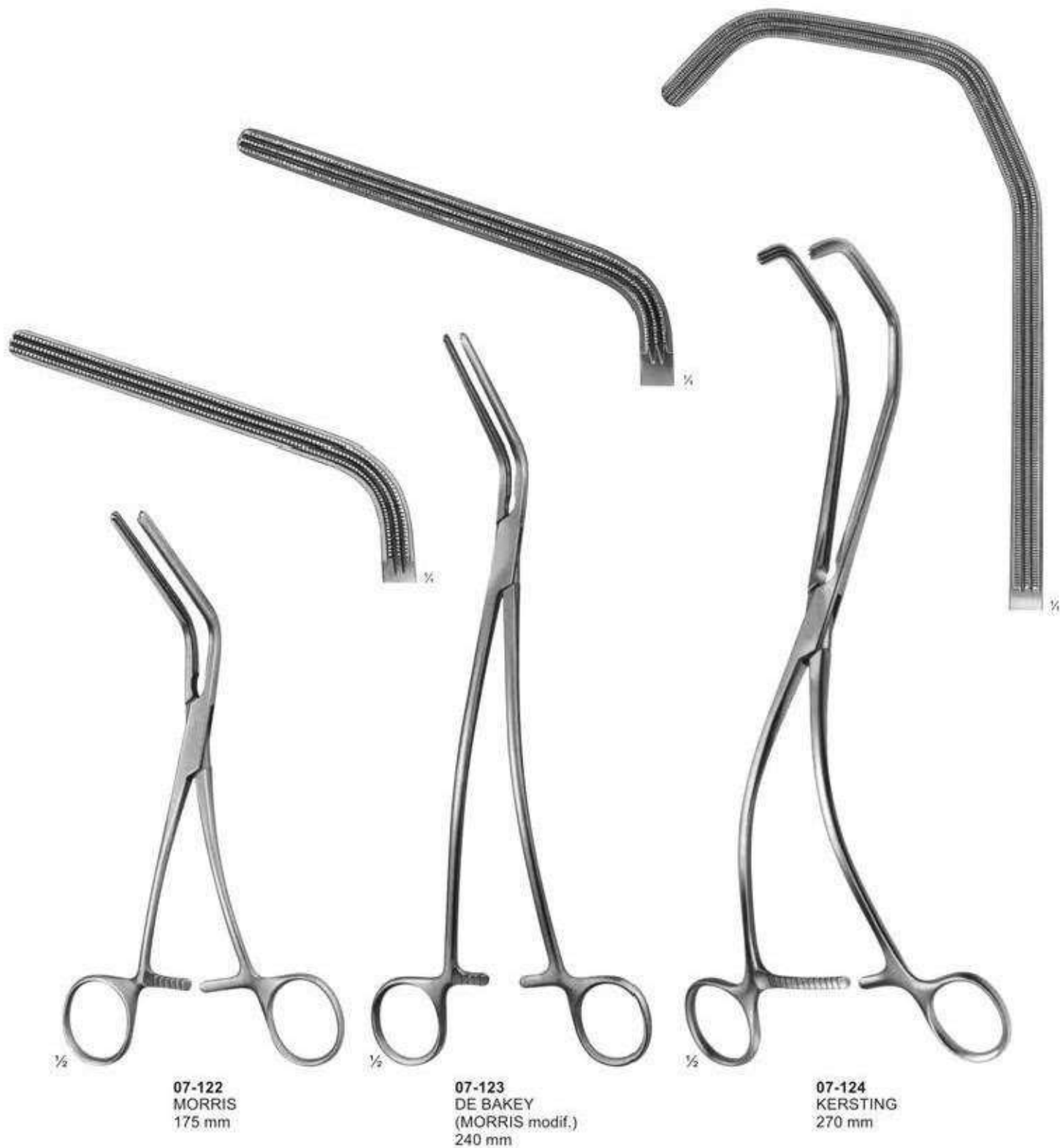

1/4

07-122
MORRIS
175 mm

1/4

07-123
DE BAKEY
(MORRIS modif.)
240 mm

1/4

07-124
KERSTING
270 mm



08-101
Martin
13 cm / 5 1/8"



08-102
SIMS
160 mm

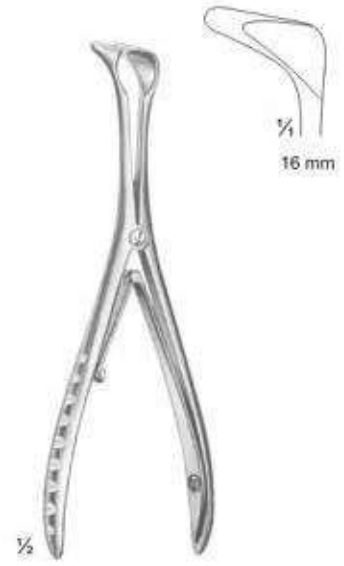

08-103
Tieck-Halle
13 cm / 5 1/8"



08-104
Killian

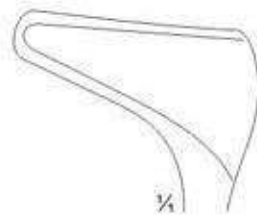

Fig. 1
14 cm 5 4/8"
35 mm

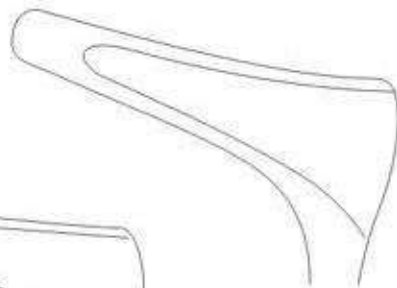

Fig. 2
14,5 cm / 5 4/8"
50 mm

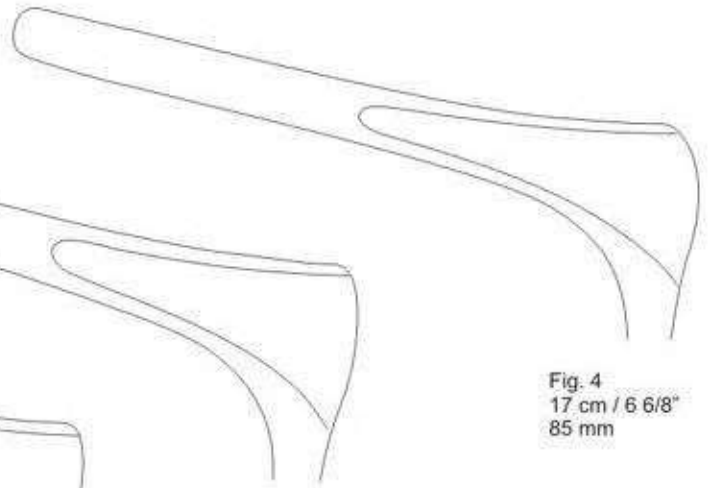

Fig. 3
16 cm / 6 2/8"
75 mm

Fig. 4
17 cm / 6 6/8"
85 mm



08-105
Cottle

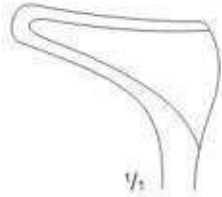

Fig. 1
13,5 cm / 5 3/8"
35 mm

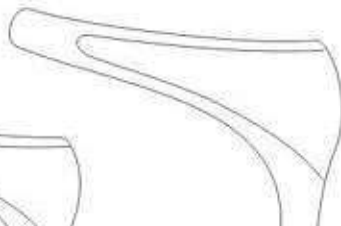

Fig. 2
14 cm / 5 4/8"
50 mm

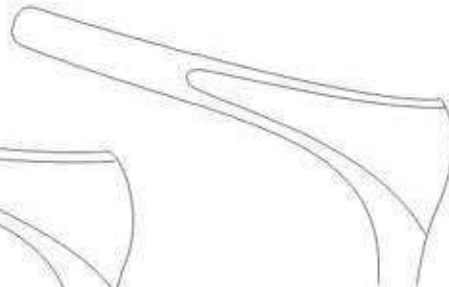

Fig. 3
16 cm / 6 2/8"
75 mm

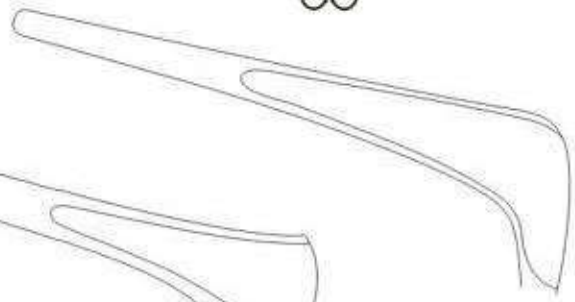

Fig. 4
16 cm / 6 2/8"
85 mm



08-106
Goldsmith (Thudichum)
6,5 cm / 2 4/8"



Fig. 1
21,0 x 9,5 mm

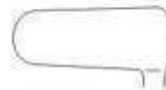

Fig. 2
21,0 x 10,5 mm



Fig. 3
21,0 x 11,5 mm



08-107
Mod. Wien 2
13,5 cm / 5 2/8"

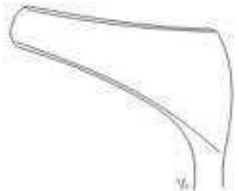

Fig. 1
30 mm



08-108
Hartmann-Halle
16 cm / 6 1/8"



Fig. 1
27 mm

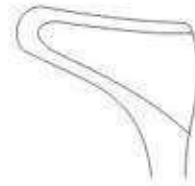

Fig. 2
31 mm

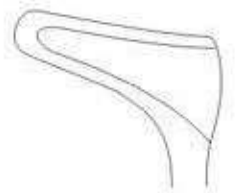

Fig. 3
35 mm



08-109
IVES-FANSLER
Anuscopy
145 mm
Ø24mm



08-110
KELLY
Sphincteroscope
160 mm
Ø21mm



08-111
KELLY
Sphincteroscope
160 mm
Ø27mm

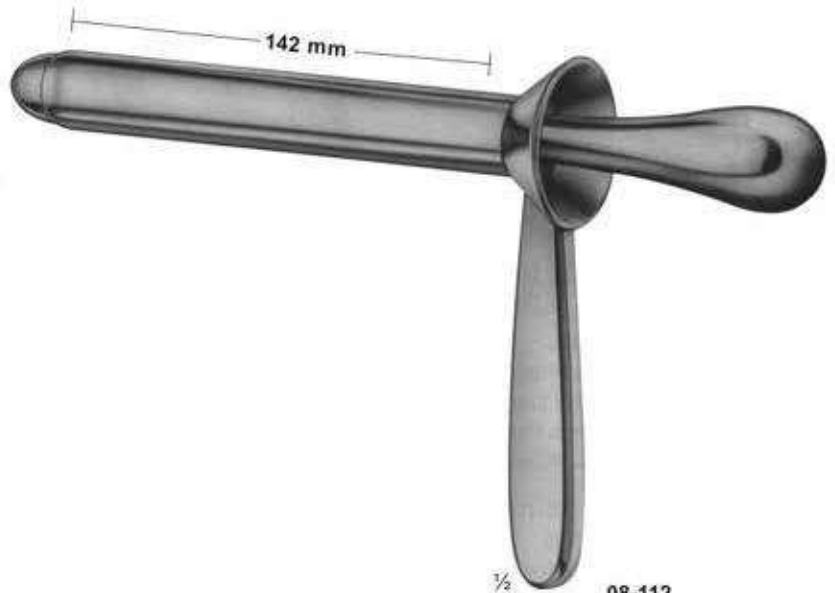

08-112
KELLY
Proctoscope
140 mm
Ø22mm

ATRAUMATA

Pressure Clamp

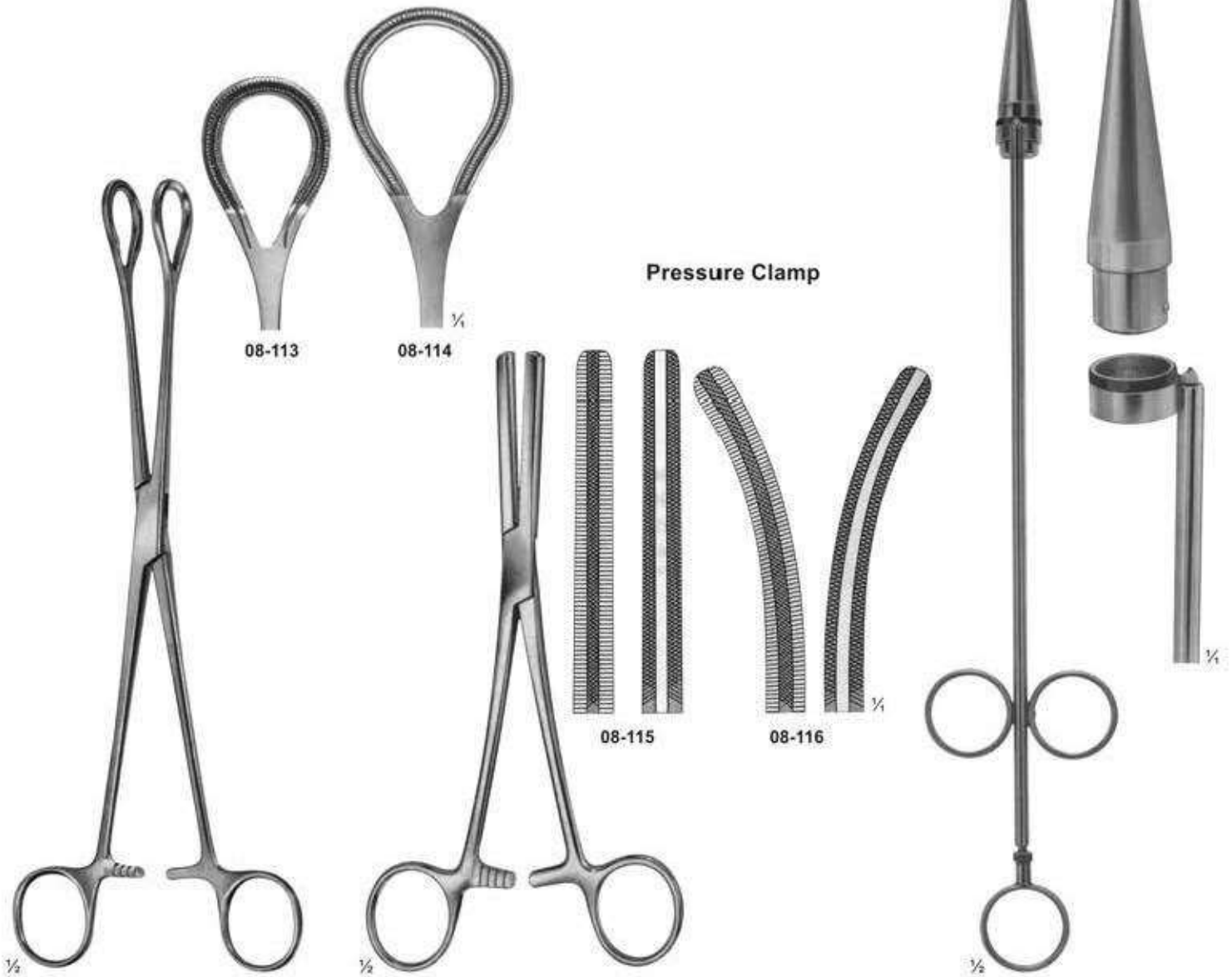

08-113 - 08-114
250 mm
08-114
270 mm

08-115 - 08-116
FERGUSSON
200 mm

08-117
RUDD
Haemorrhoidal ligator
with loading
attachment and 100
ligature rubber rings
315 mm



08-118
LOWER
180 mm



08-119
LAHEY (SWEET)
190 mm



08-120
LAHEY
220 mm



08-121
DESJARDINS
Gall duct-and cystic forceps
210 mm



08-122
NISSEN
Gall duct-and cystic forceps
215 mm



- Charr.
(French)**
- 08-123 8
 - 08-124 9
 - 08-125 10
 - 08-126 11
 - 08-127 12
 - 08-128 13
 - 08-129 14
 - 08-130 15
 - 08-131 16
 - 08-132 17
 - 08-133 18
 - 08-134 19
 - 08-135 20
 - 08-136 21
 - 08-137 22
 - 08-138 23
 - 08-139 24
 - 08-140 25
 - 08-141 26
 - 08-142 27
 - 08-143 28
 - 08-144 29
 - 08-145 30

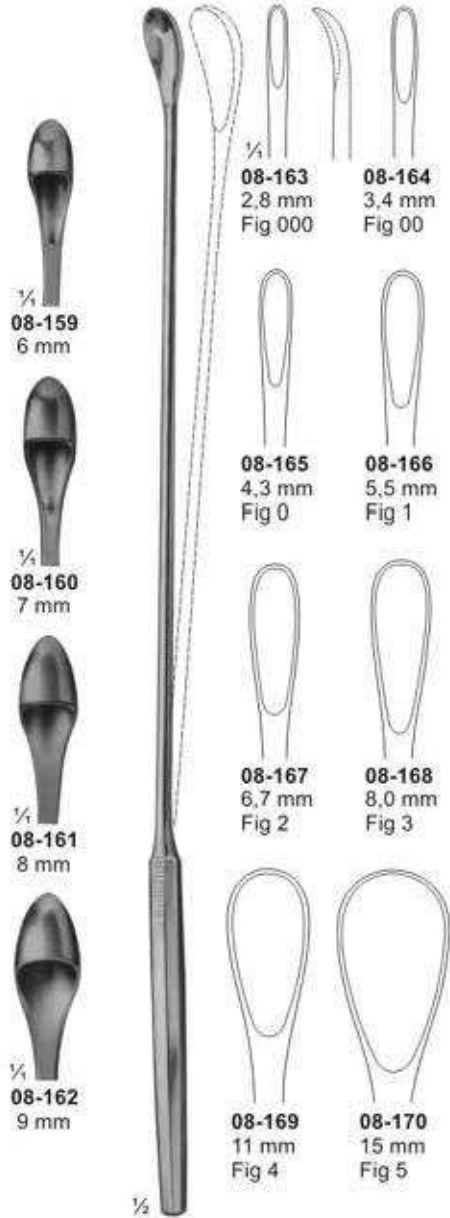
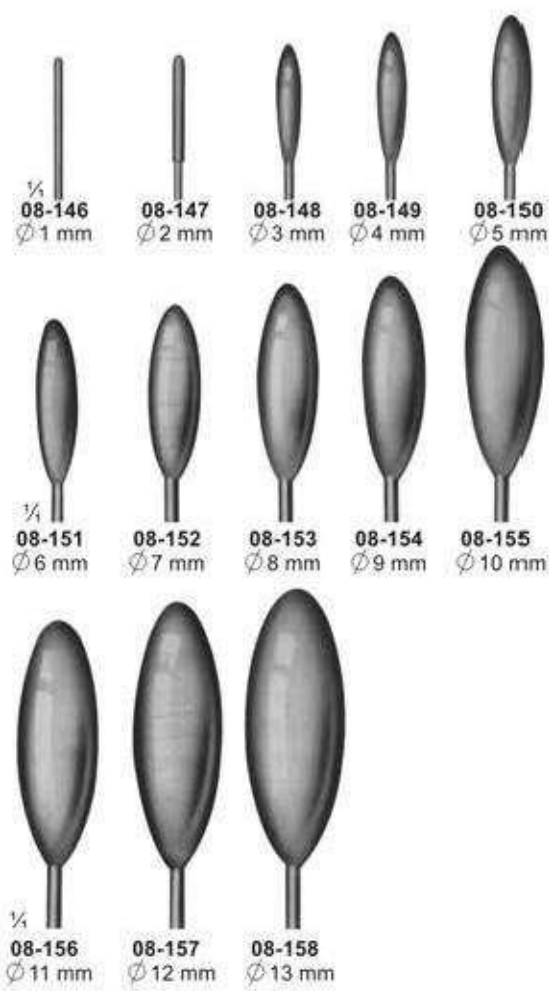

08-123 - 08-145
DITTEL
Metall bougies and dilating sounds, stiff 345 mm

08-146 - 08-158
BAKES
Common bile duct dilators, malleable
08-146 - 08-150 315 mm
08-151 - 08-158 320 mm

08-159 - 08-162
DESJARDINS
Probe and catch with flexible shaft 300 mm

08-163 - 08-170
LUER-KOERTE modif
with malleable shaft 310 mm

Gall Stone Forceps

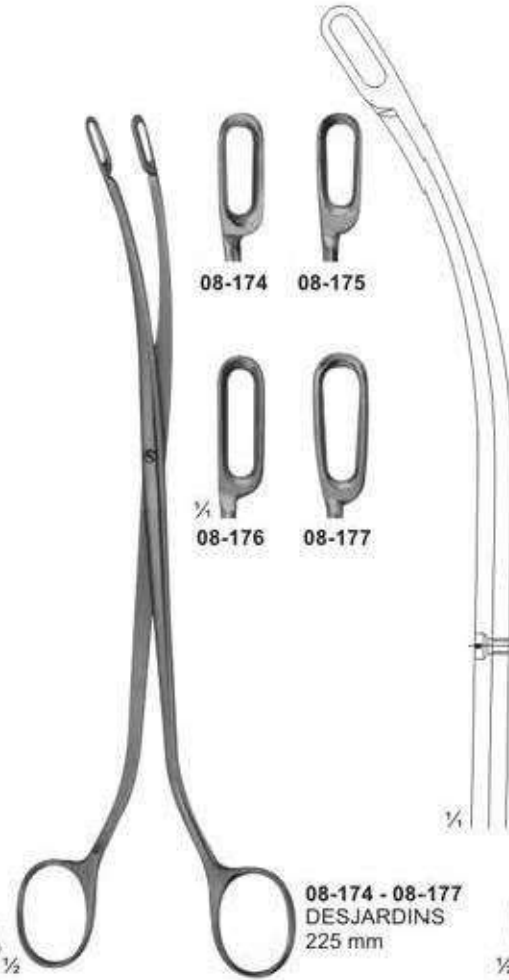
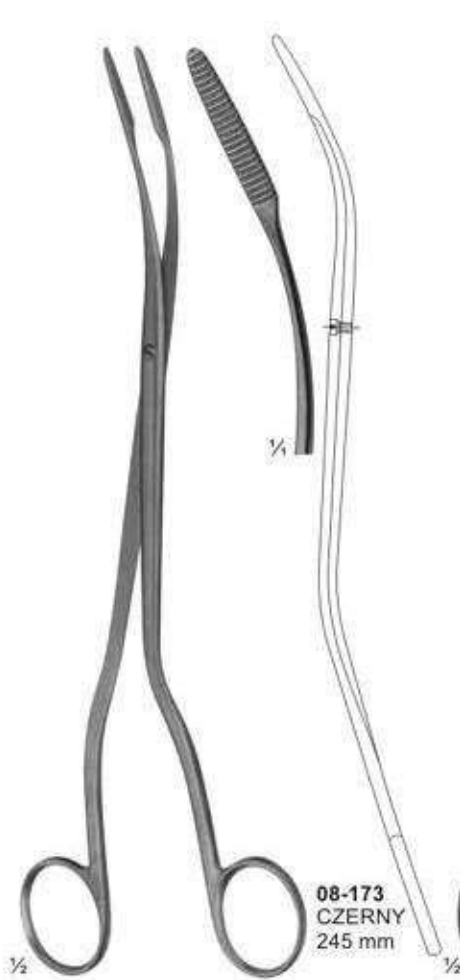
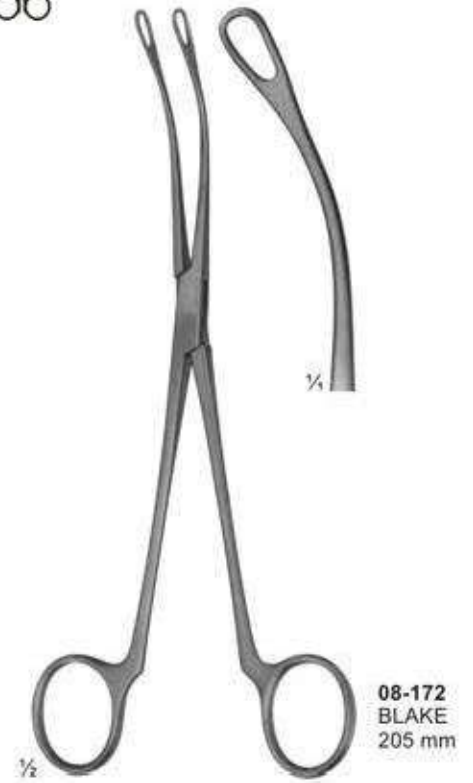

ATRAUMATA



Kidney Stone Forceps



08-186



08-187



08-188



$\frac{1}{2}$
08-189



08-190



08-191



$\frac{1}{2}$
08-192



$\frac{1}{2}$

08-186 - 08-189
RANDALL
225 mm



$\frac{1}{2}$

08-190 - 08-192
RANDALL
190 mm

Bladder Retractors



09-101
JUDD-MASSON
 Bladder-and suprapubic
 retractor

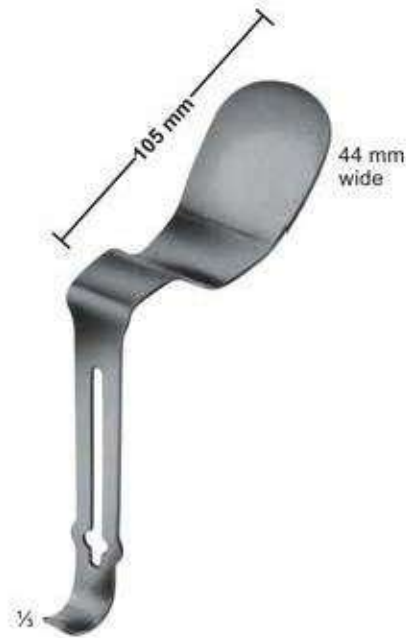

09-102
MILLIN
 Center bladder for
 retro pubic prostatectomy



09-103
MILLIN
 Bladder retractor, complete
 105X45 mm



09-104
LEGUEU
 Bladder retractor
 Center blade
 80 x 31 mm



09-105
KOCHER
 Bladder spatula
 235 mm



09-106
KLIMA ROSEGGER
35 X 1,8 mm
Sternal puncture needle



09-107
Universal trocar
with 4 tips



NELSON



09-108 - 112
Inside diam. Outside diam
09-108 2,2 mm 3,0 mm
09-109 3,0 mm 4,0 mm
09-110 4,0 mm 5,0 mm
09-111 5,0 mm 6,0 mm
09-112 5,5 mm 6,5 mm
for hydrocele and abdominal puncture

09-113 - 116
Inside diam. Outside diam
09-113 2,2 mm 3,0 mm
09-114 3,0 mm 4,0 mm
09-115 4,0 mm 5,0 mm
09-116 5,0 mm 6,0 mm
for abdominal puncture,
with stop-cock and lateral
drain



09-117 - 118
Inside diam. Outside diam
09-117 6,5 mm 8,0 mm
09-118 9,0 mm 10,0 mm
Empyema trocar
BUELEU



09-119 - 122
Inside diam. Outside diam
09-119 3,0 mm 4,0 mm
09-120 3,6 mm 4,6 mm
09-121 4,3 mm 5,3 mm
09-122 5,0 mm 6,0 mm
Gall bladder trocars. OCHSNER



09-123
PIERCE
Antrum trocar
Ø 4,0 mm



09-124
COAKLEY
Antrum trocar
3,0 mm

Vaginal Specula



10-101
COLLIN
for children
53 x 10 mm

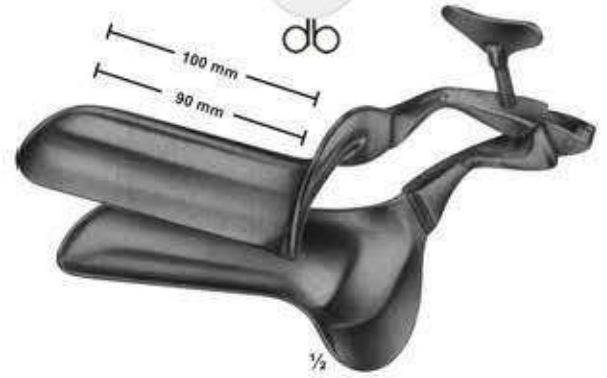

10-102 - 105
COLLIN

10-102	100/90mm	28 mm
10-103	100/90mm	32 mm
10-104	105/95mm	35 mm
10-105	115/105mm	40 mm

 Total length/working length width



10-106
COLLIN
for virgins
95/85 x 18 mm



10-107
CUSCO
for virgins
75 x 17 mm



10-108
CUSCO
for virgins
75 x 17 mm

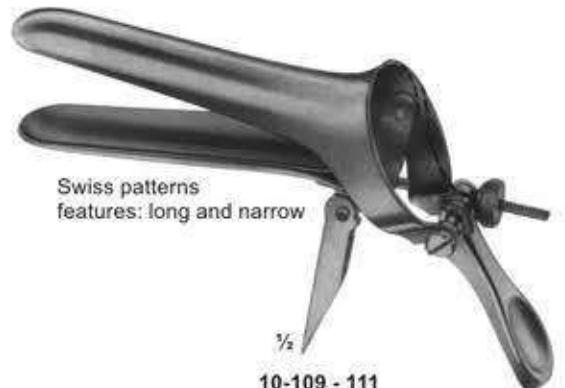

Swiss patterns
features: long and narrow

10-109 - 111
CUSCO

10-109	92X23-25 mm
10-110	100x25-27 mm
10-111	110x27-30 mm

Vaginal Specula- Sets, upper and lower blades



10-112 - 114
GRAVE
10-112 75X20 mm
10-113 95X30 mm
10-114 105X33 mm

1/2



10-115 - 116
PEDERSON
10-115 100X22 mm
10-116 120X25 mm

1/2



10-117 - 118
BRIESKY
10-117 72X25 mm / 77X30 mm 140 mm
10-118 75X30 mm / 92X38 mm 170 mm

1/2



10-119
SIMS
70 X 26 mm / 75 X 30 mm
75 X 30 mm / 80 X 35 mm
80 X 36 mm / 90 X 40 mm
175 mm

1/2



10-120 - 122
SEIDL
10-120 80X8 mm
10-121 80X10 mm
10-122 90X14 mm
For children and infants
170 mm

1/2



10-123
KRISTELLER
70X15 mm, (170 mm)
For children

1/2



10-124 - 10-126
KRISTELLER
10-124 70X27 mm
10-125 75X30 mm
10-126 90X36 mm
175 mm

1/2

Vaginal Specula- upper and lower blades



10-127 - 131
KRISTELLER
 10-127 110X18 mm
 10-128 110X20 mm
 10-129 110X27 mm
 10-130 110X30 mm
 10-131 110X36 mm
 220 mm

10-132 - 10-135
KRISTELLER
 Upper blades

10-136 - 10-139
KRISTELLER
 Lower blades



1/2

10-140 - 143
DOYEN
235 mm

10-140
60 X 45 mm

10-141
90 X 45 mm

10-142
112 X 45 mm

1/4

1/4

1/2

10-143 - 10-153
DOYEN
240 mm

	width of blades		
	35 mm	45 mm	60 mm
length of blades	60 mm	35 mm	45 mm
	90 mm	10-143	10-146
	120 mm	10-144	10-147
	160 mm	10-145	10-148
		60 mm	10-150
			10-151
			10-152
			10-153



1/2
10-154
JOLL (FRIEDMAN)
155 mm



1/4
10-155
RICHTER
170 mm



1/4
10-156
GELPI
135 mm



1/4
10-157
GELPI
175 mm



11-101	1	mm	11-123	23	mm
11-102	2	mm	11-124	24	mm
11-103	3	mm	11-125	25	mm
11-104	4	mm	11-126	26	mm
11-105	5	mm	11-127	1	½mm
11-106	6	mm	11-128	2	½mm
11-107	7	mm	11-129	3	½mm
11-108	8	mm	11-130	4	½mm
11-109	9	mm	11-131	5	½mm
11-110	10	mm	11-132	6	½mm
11-111	11	mm	11-133	7	½mm
11-112	12	mm	11-134	8	½mm
11-113	13	mm	11-135	9	½mm
11-114	14	mm	11-136	10	½mm
11-115	15	mm	11-137	11	½mm
11-116	16	mm	11-138	12	½mm
11-117	17	mm	11-139	13	½mm
11-118	18	mm	11-140	14	½mm
11-119	19	mm	11-141	15	½mm
11-120	20	mm	11-142	16	½mm
11-121	21	mm	11-143	17	½mm
11-122	22	mm			

11-101 - 143
HEGAR
with very conical point
185 mm



11-144	1+2	mm
11-145	3+4	mm
11-146	5+6	mm
11-147	7+8	mm
11-148	9+10	mm
11-149	11+12	mm
11-150	13+14	mm
11-151	15+16	mm
11-152	17+18	mm

11-144 - 152
HEGAR
205 mm

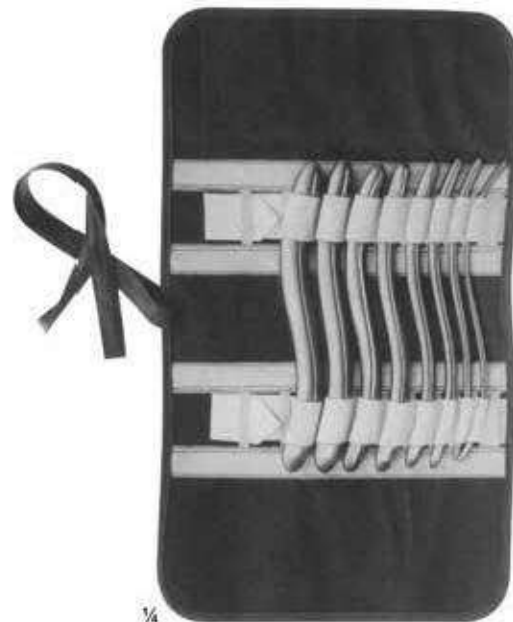

11-153
HEGAR
Uterine dilator set, in canvas
roll with 8 dilators.

5 mm



11-154
MAYO
malleable
330 mm

4 mm



11-155
SIMS
malleable
330 mm

3 mm



11-156
MARTIN
330 mm

4 mm



11-157
SIMPSON
malleable
silver-plated
290 mm



11-158
BRAUN
Uterine
depressor
270 mm

24 mm



11-159
Cotton
applicator
270 mm



11-160
PELMANN
260 mm



11-161
PELMANN
260 mm



11-162
BOZEMANN
250 mm



11-163
BOZEMANN
255 mm

Jaws with longitudinal groove



11-164
HEYWOOD-SMITH
200 mm

11-165
KELLY
320 mm

11-166
HEYWOOD-SMITH
250 mm

11-167
NOTO
280 mm



12-101
Langenbeck
13 cm / 5 1/8"

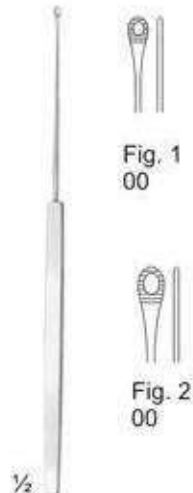

12-102
Shapleigh
15 cm / 5 1/8"

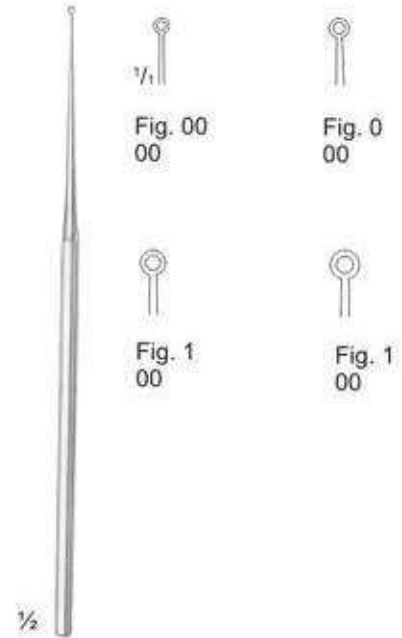

12-103
Buck
17cm / 6 6/8"



12-104
Buck
15 cm / 6 6/8"

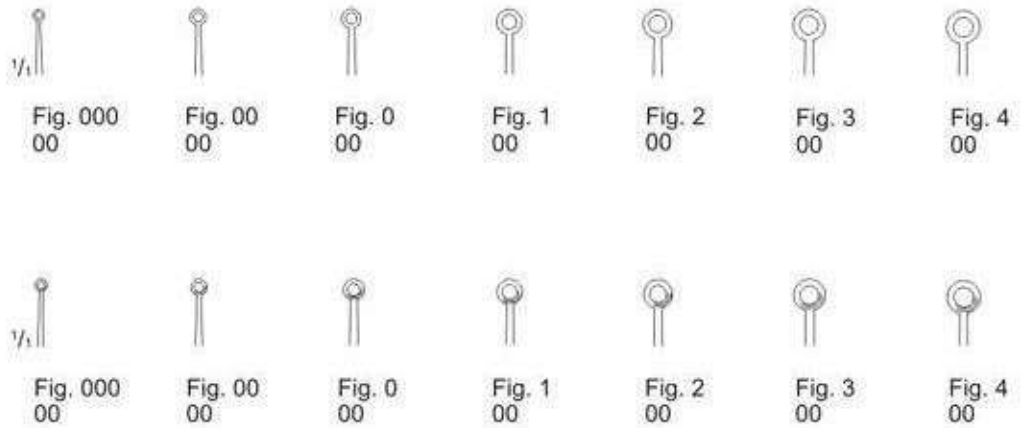

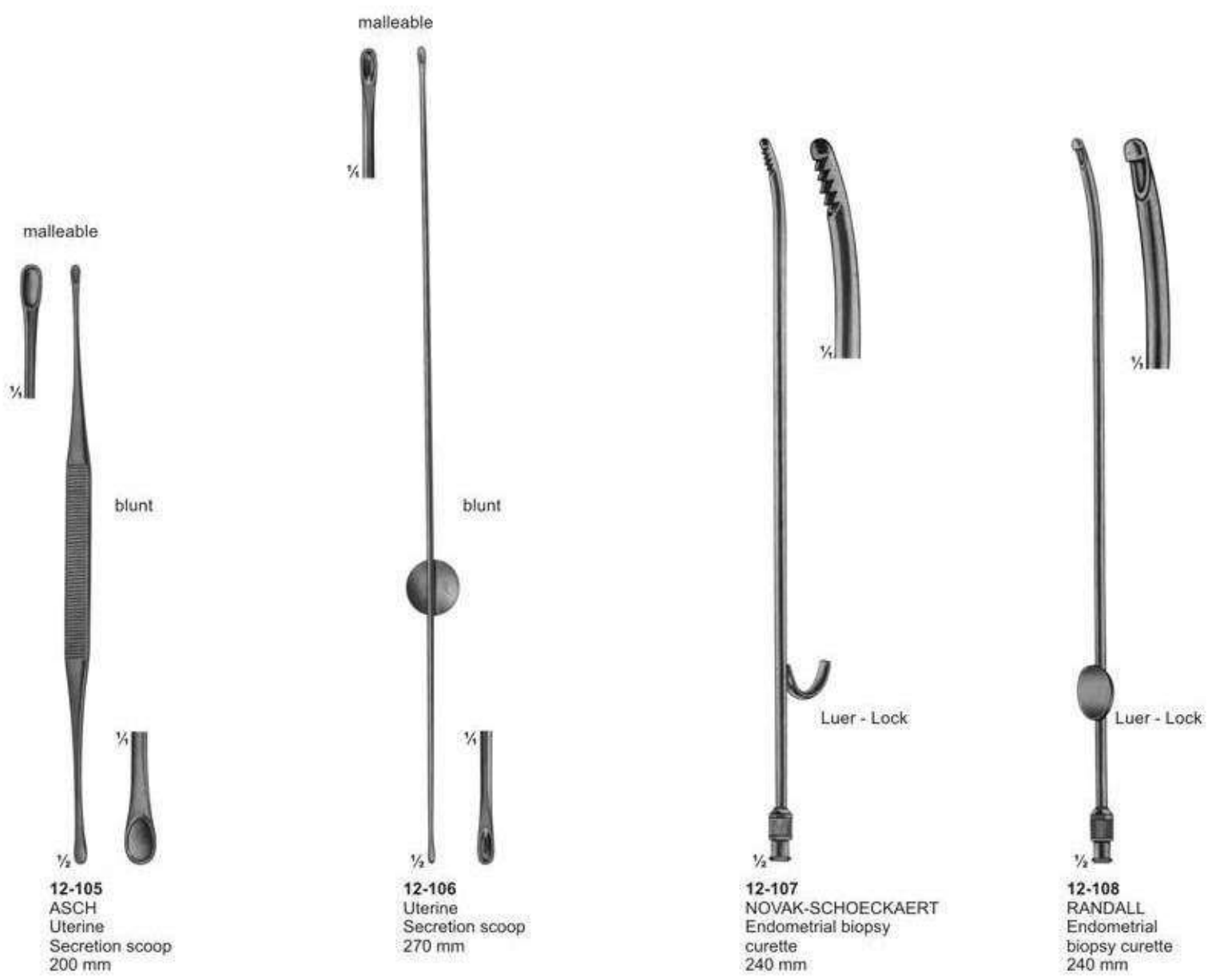

12-105
ASCH
 Uterine
 Secretion scoop
 200 mm

12-106
Uterine
 Secretion scoop
 270 mm

12-107
NOVAK-SCHOECKAERT
 Endometrial biopsy
 curette
 240 mm

12-108
RANDALL
 Endometrial
 biopsy curette
 240 mm



12-109
Hartmann-Wullstein
shaft length
85 mm



12-110
Hartmann-Wullstein
shaft length
85 mm



12-111
Hartmann
shaft length
85 mm



12-112
Hartmann
shaft length
85 mm



12-109 - 12-119

12-113
14 cm / 5 4/8"
shaft length
140 mm

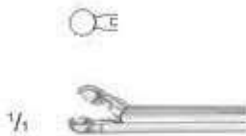

12-114
Hartmann-Herzfel
2,0 mm
shaft length
85mm



12-115
Hartmann
3 mm
shaft length
85mm

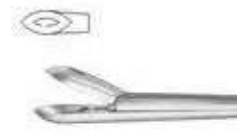

12-116
shaft length
85mm



12-117
Hartmann-Hoffmar
2,0 mm
85mm

12-118
2,5 mm
85 mm

12-119
3,0 mm
85 mm

Biopsy forceps for rectum

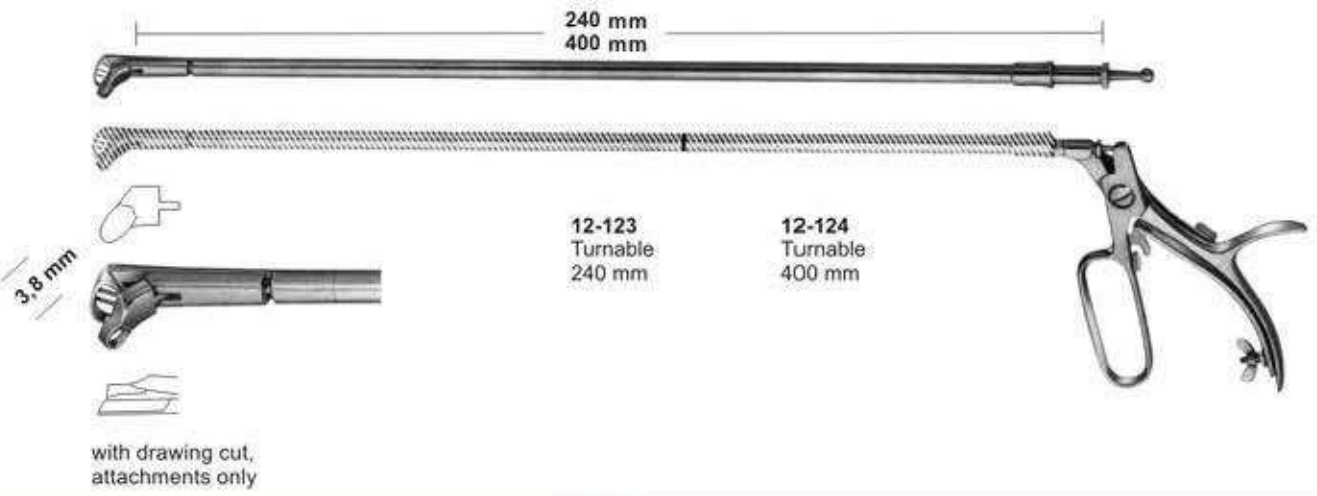
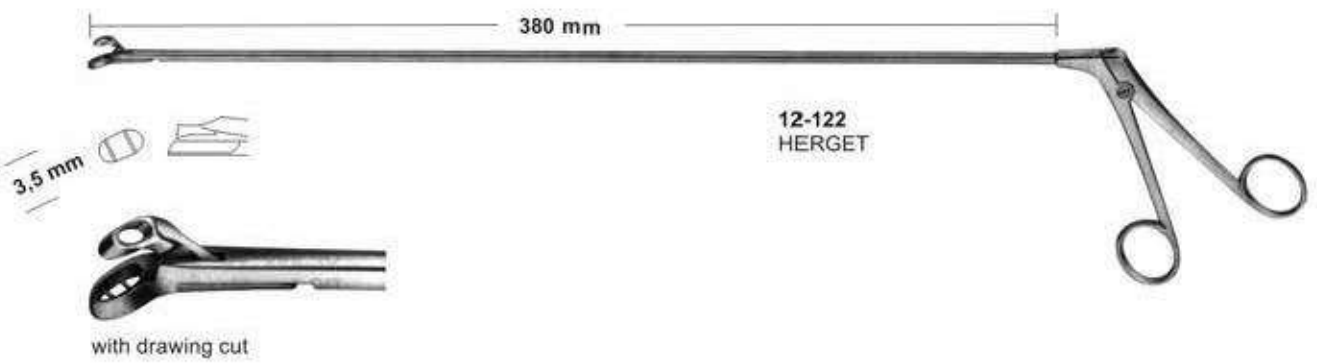
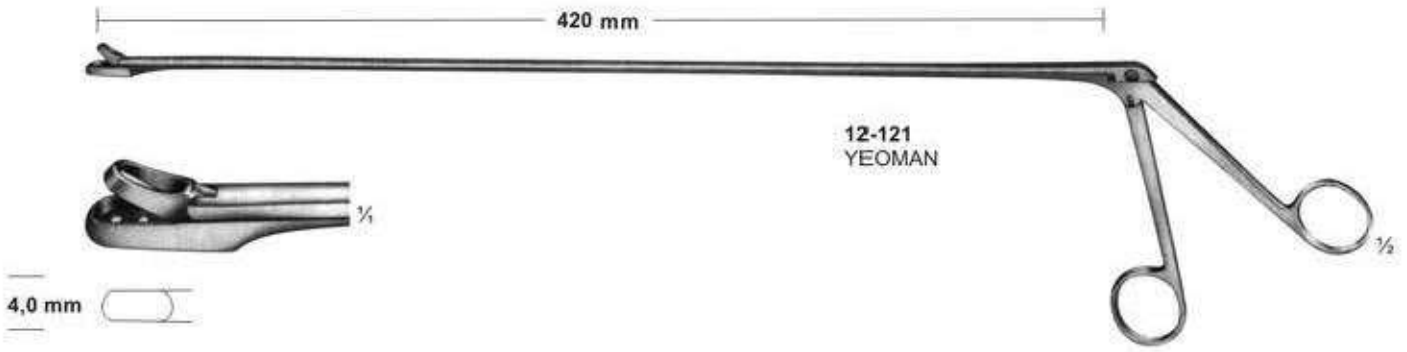
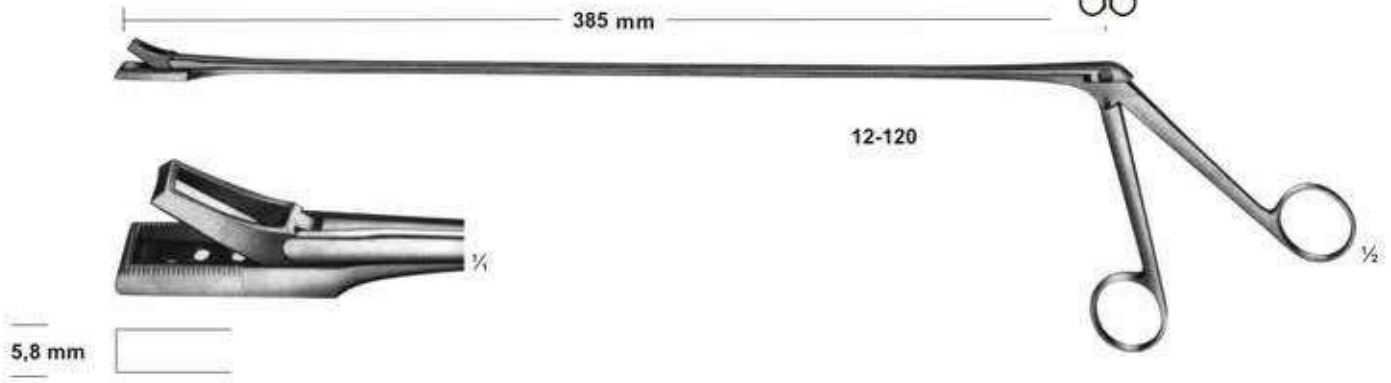

Biopsy Forceps

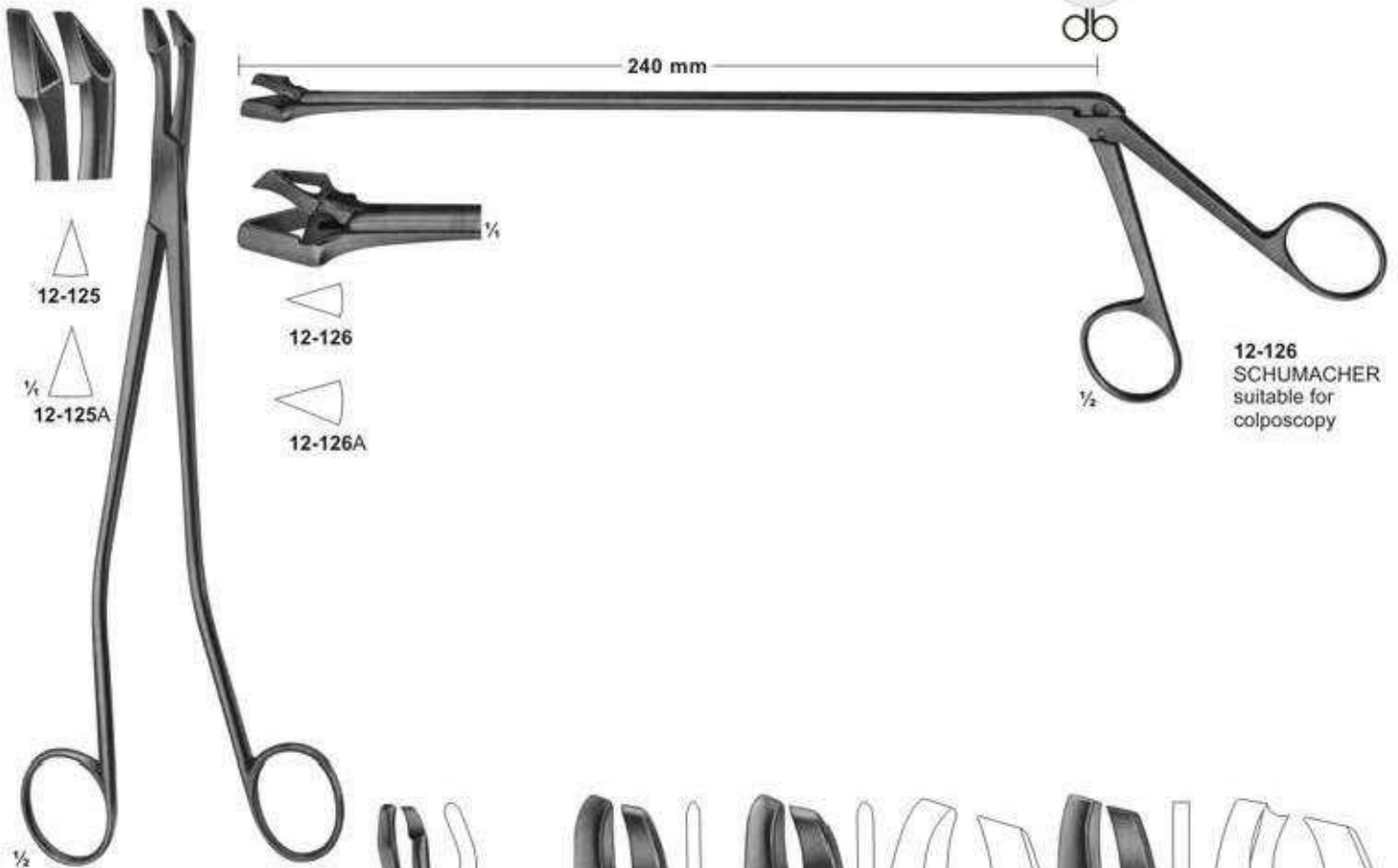

12-125

12-125A

12-126

12-126A

12-126
SCHUMACHER
suitable for
colposcopy

12-125
SCHUMACHER
240mm

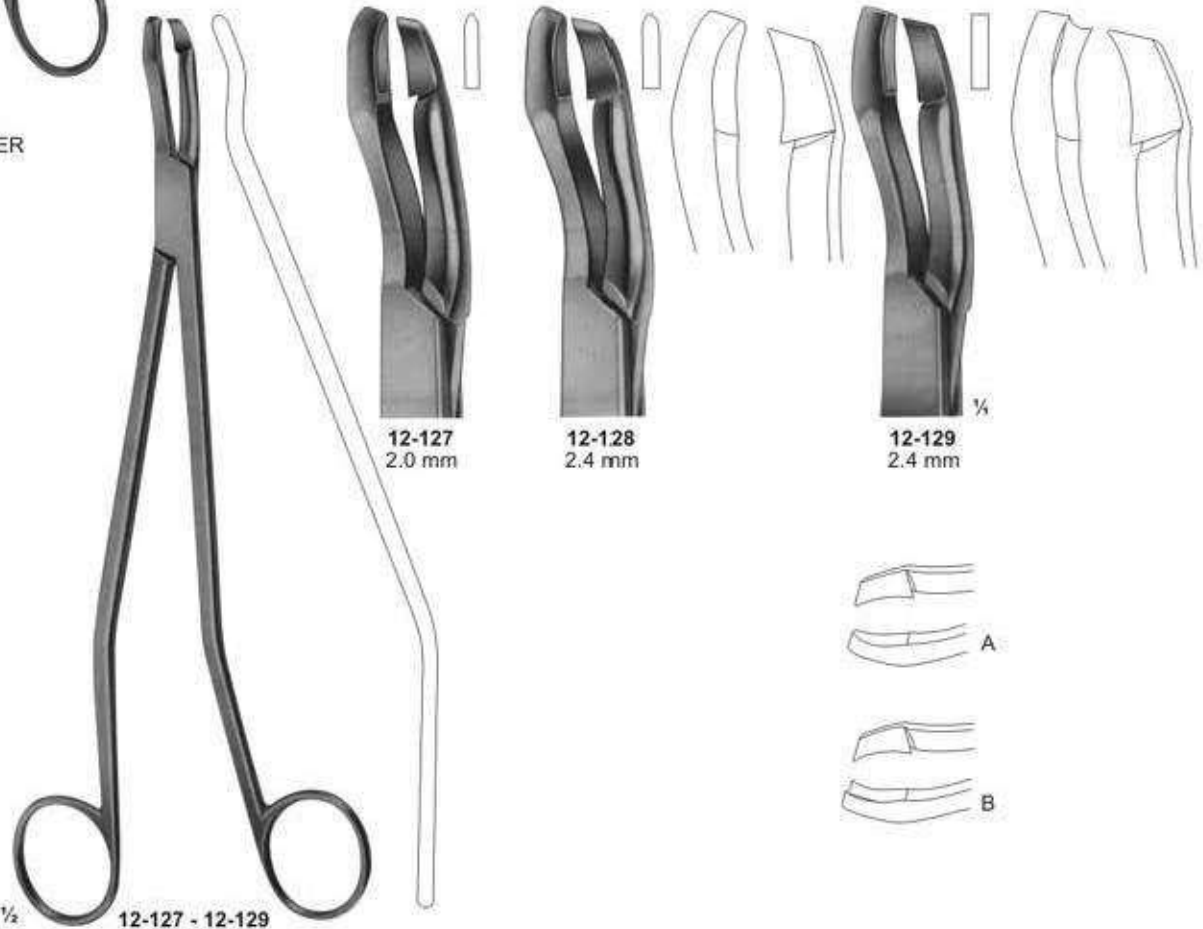

12-127
2.0 mm

12-128
2.4 mm

12-129
2.4 mm

12-127 - 12-129
SEIDL DBP
Biopsy forceps, bayonet shaped
for portio, vagina and vulva
240mm

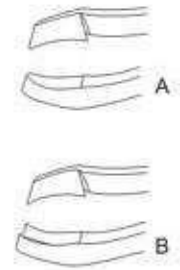

Biopsy Forceps

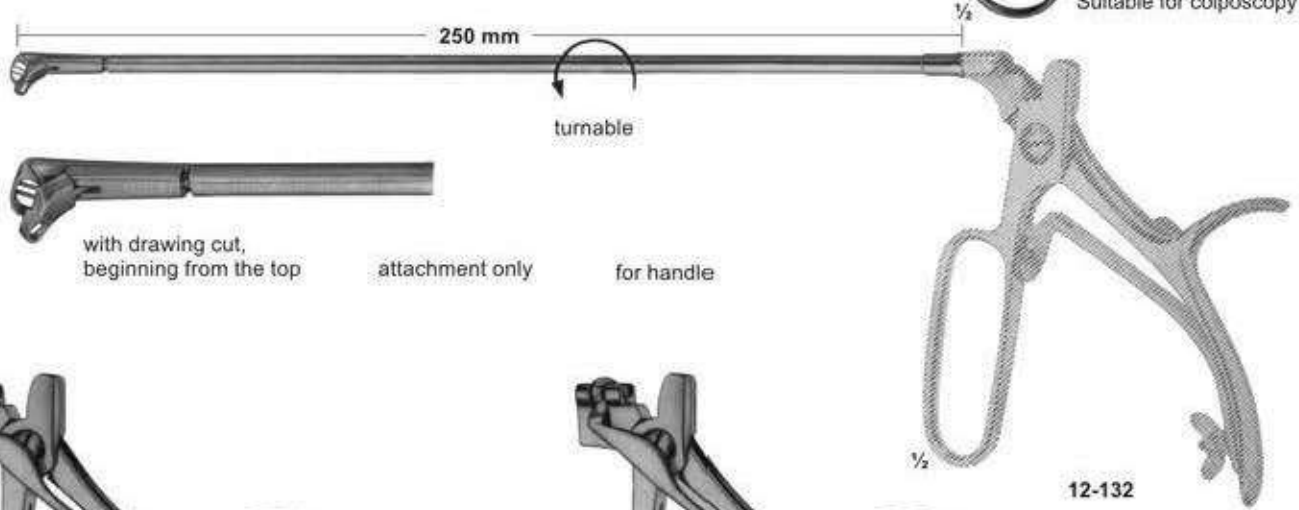
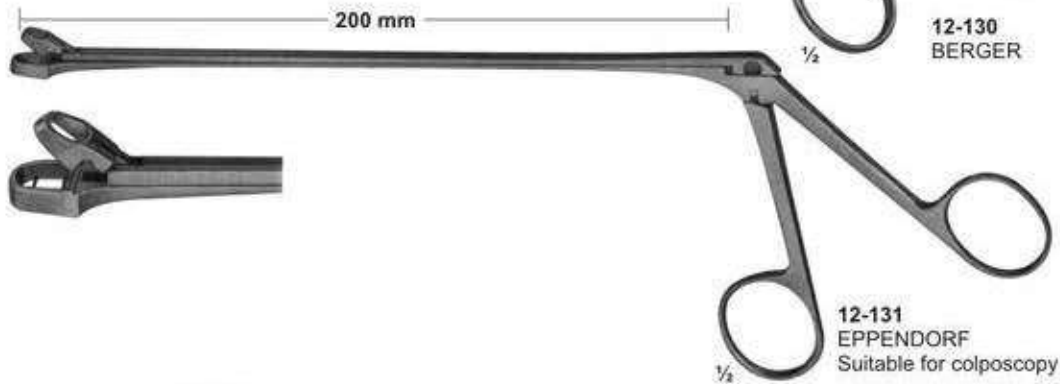
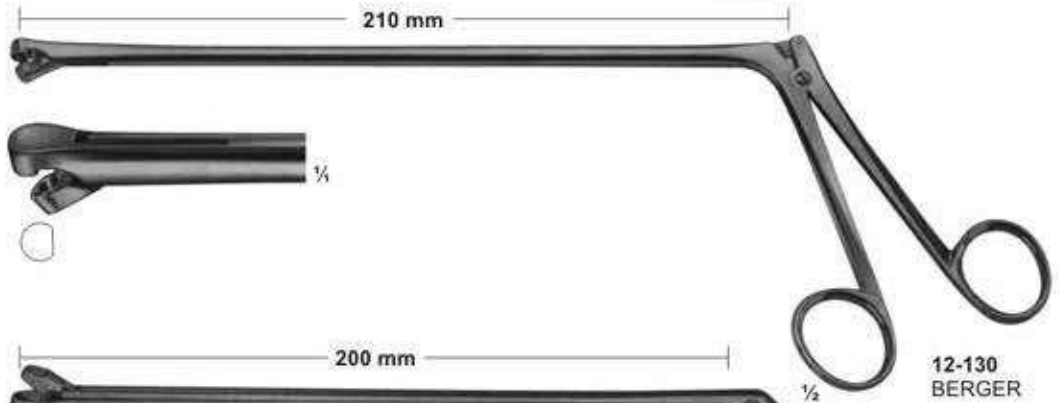

Uterine Scoops

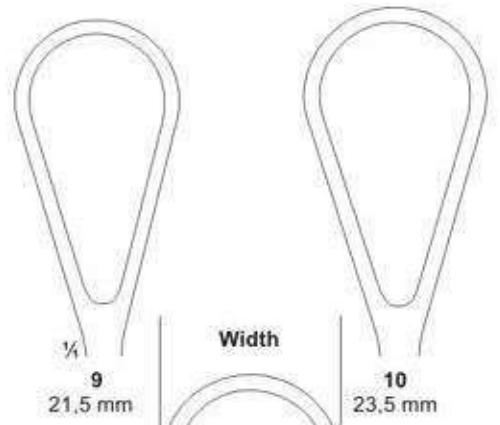
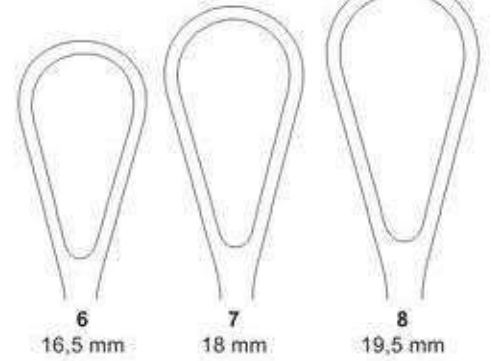
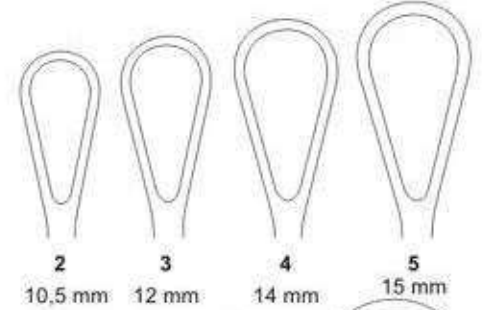
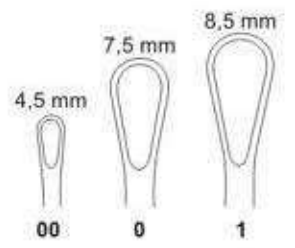

1/2
12-140
SIMON
240 mm

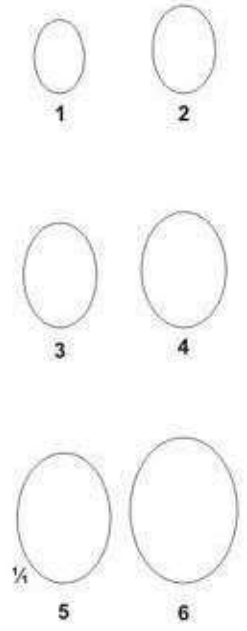

1/2
12-141
SCHROEDER
310 mm

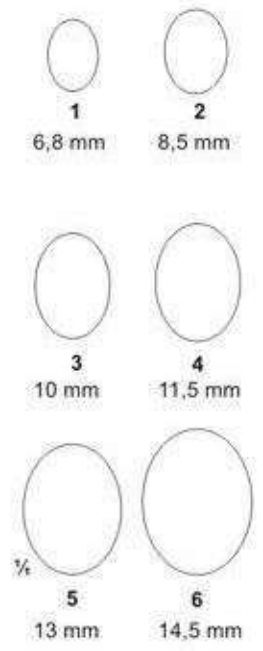

1/2
12-142
RECAMIER
300 mm



13-101
NAEGELE
355 mm



13-102
NAEGELE
400 mm



13-103
SIMPSON-BRAUN
305mm

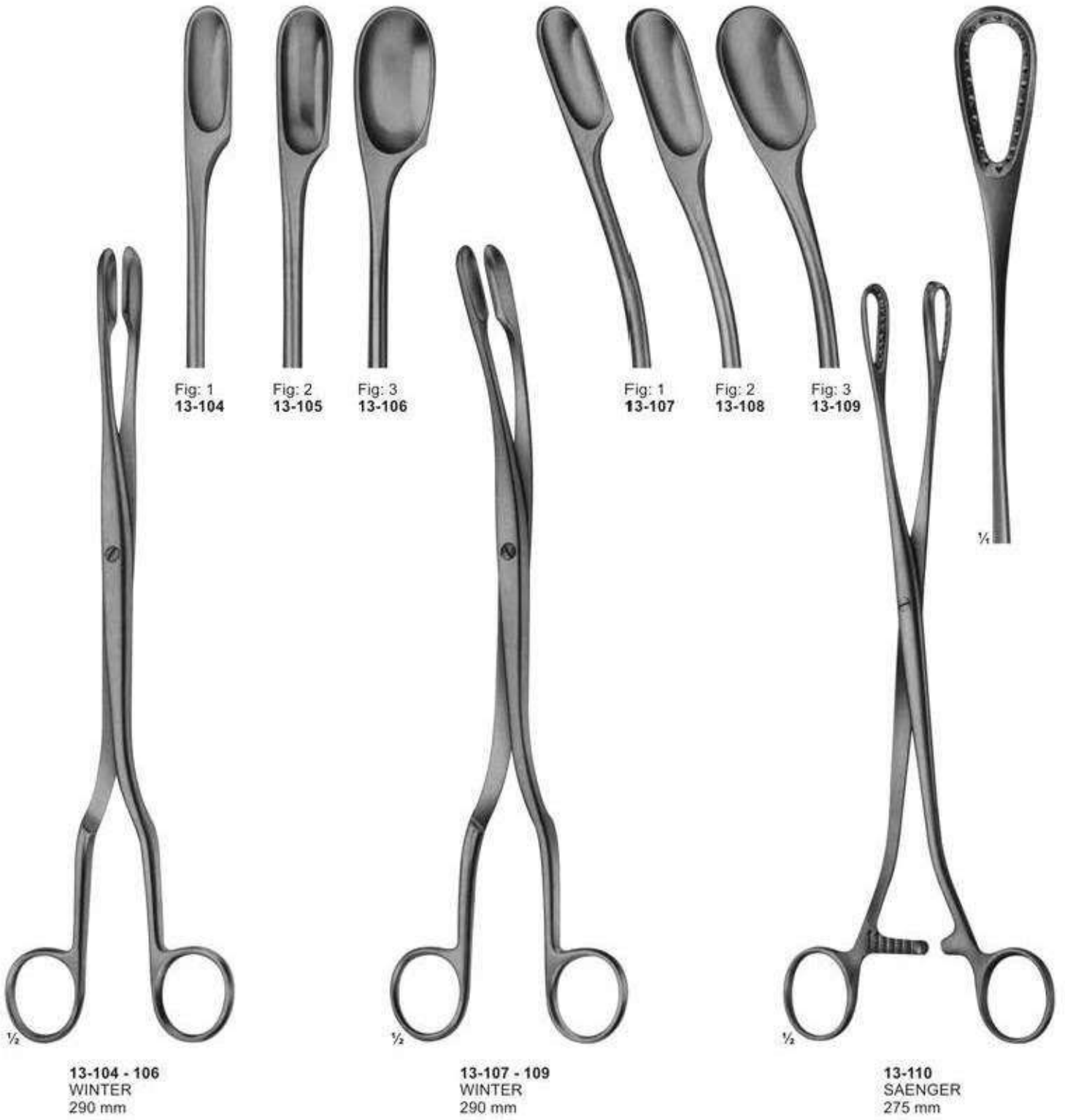

Fig: 1
13-104

Fig: 2
13-105

Fig: 3
13-106

Fig: 1
13-107

Fig: 2
13-108

Fig: 3
13-109

13-104 - 106
WINTER
290 mm

13-107 - 109
WINTER
290 mm

13-110
SAENGER
275 mm

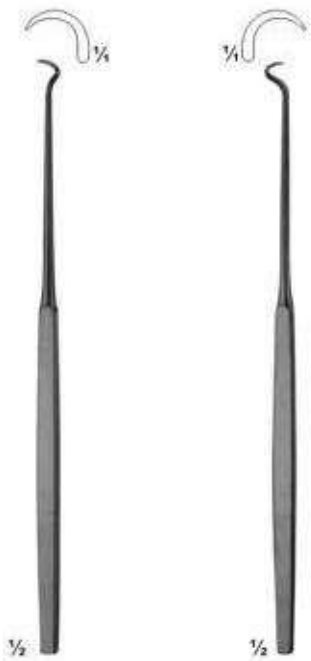

13-111
BOSE
165 mm

13-112
BOSE
165 mm



13-113 - 115
180 mm

13-113
sharp



13-114
blunt



13-115
stumpf/blunt



13-116
FINSEN
50 mm



13-117
FINSEN
70 mm



13-118
TROUSSEAU
120 mm



13-119
LABORDE
125 mm



13-120
LABORDE
strong pattern
135 mm



13-121
Cleaning Brush
for tracheal tubes
285 mm

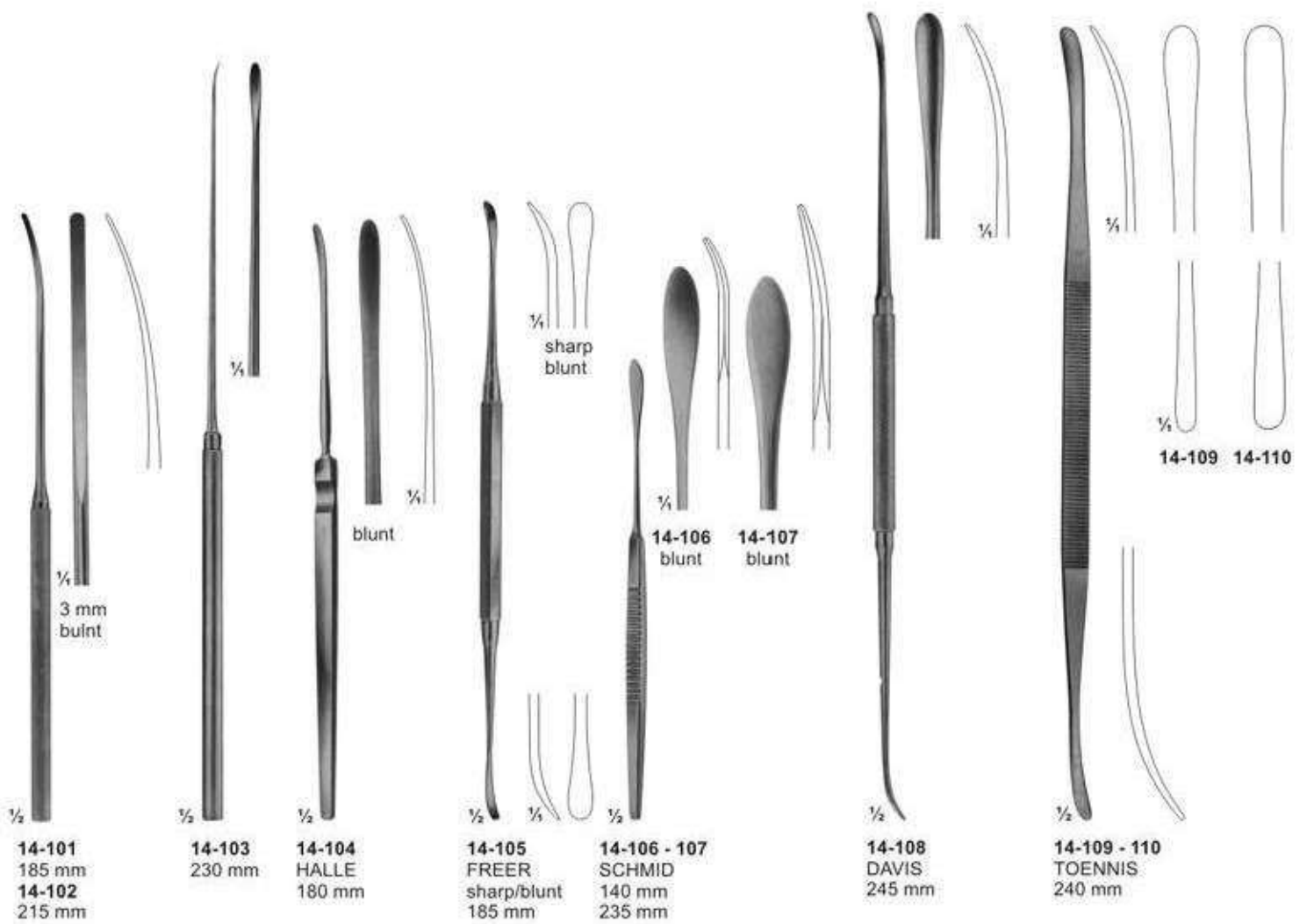

ATRAUMATA Forceps

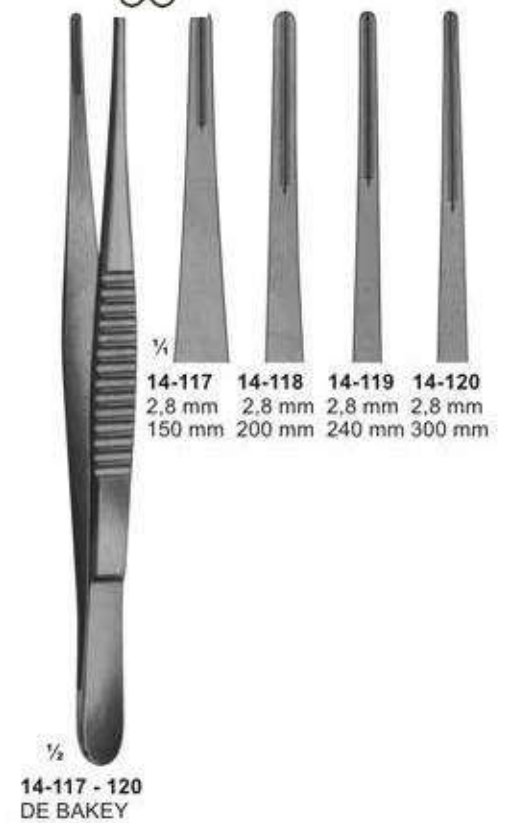
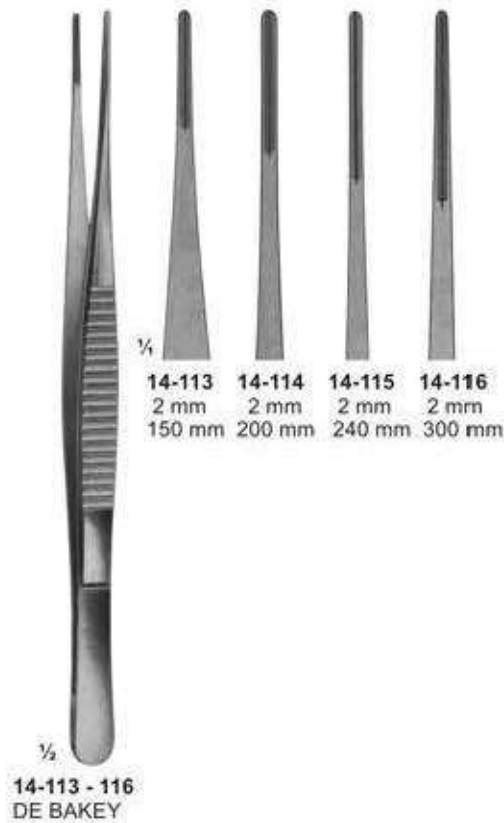
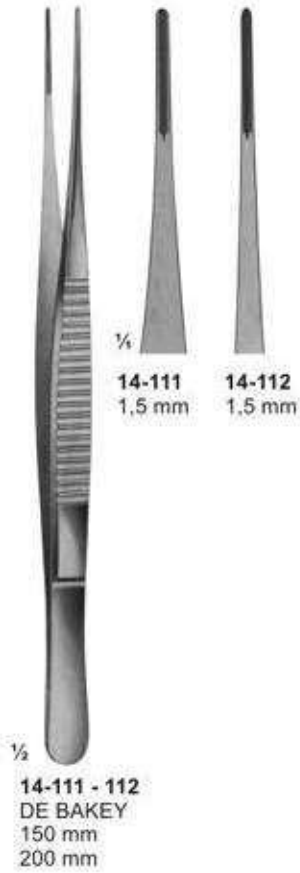

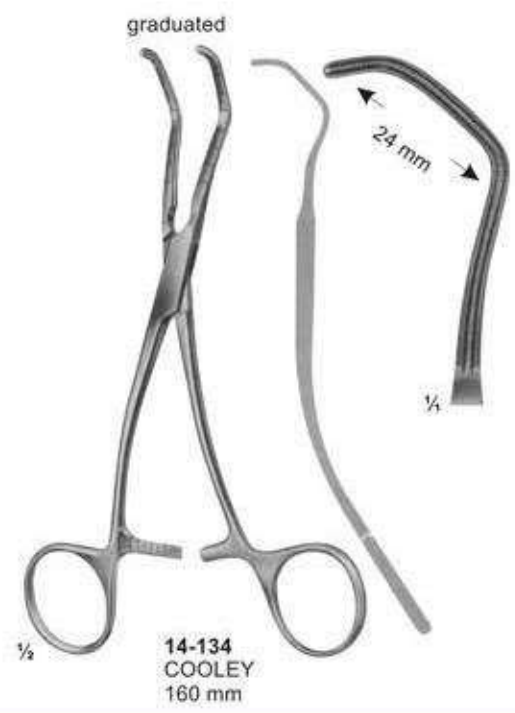
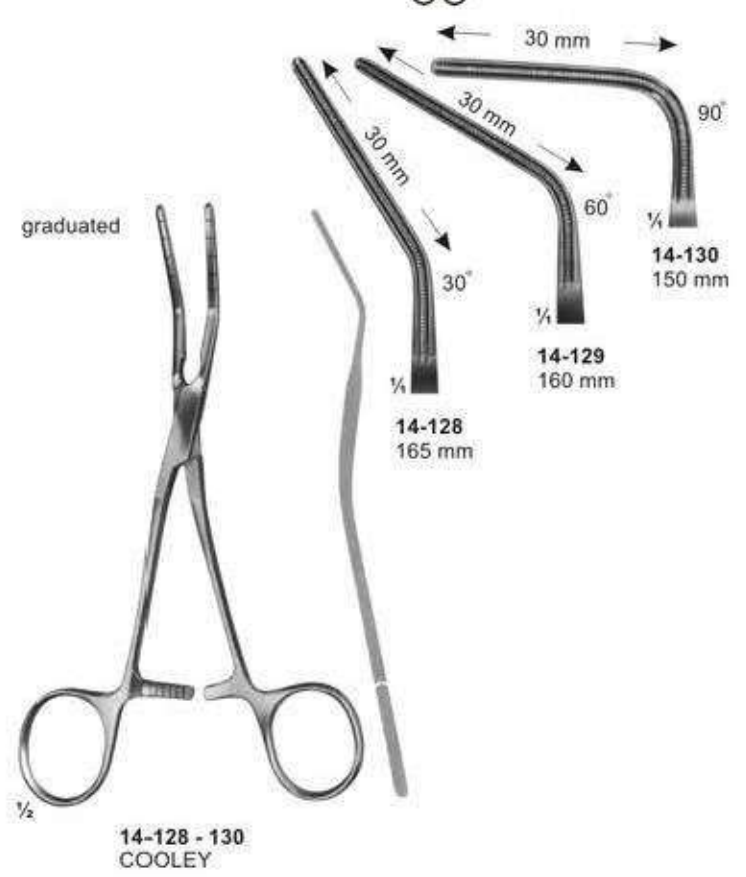
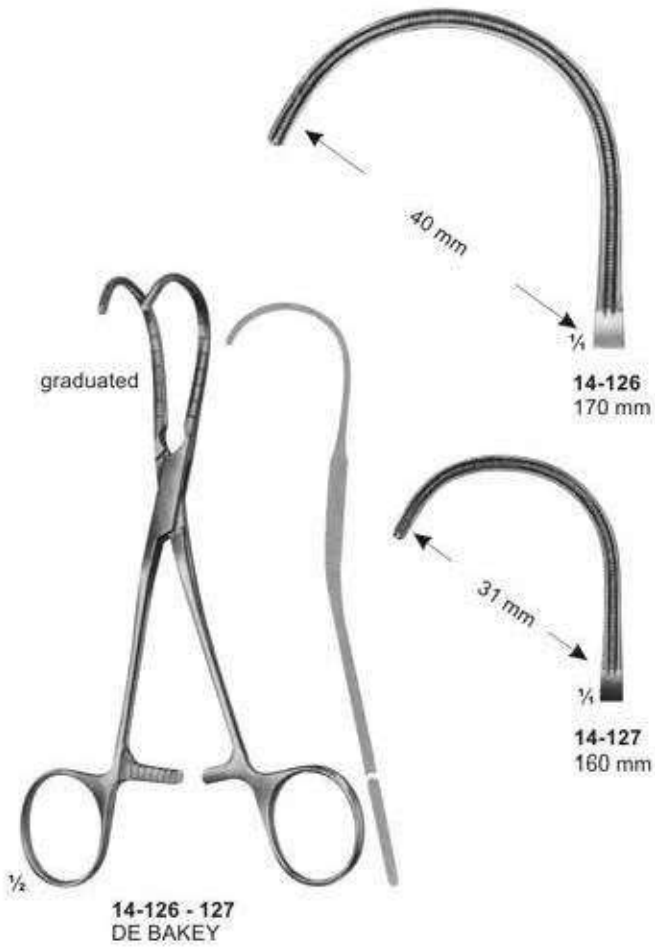

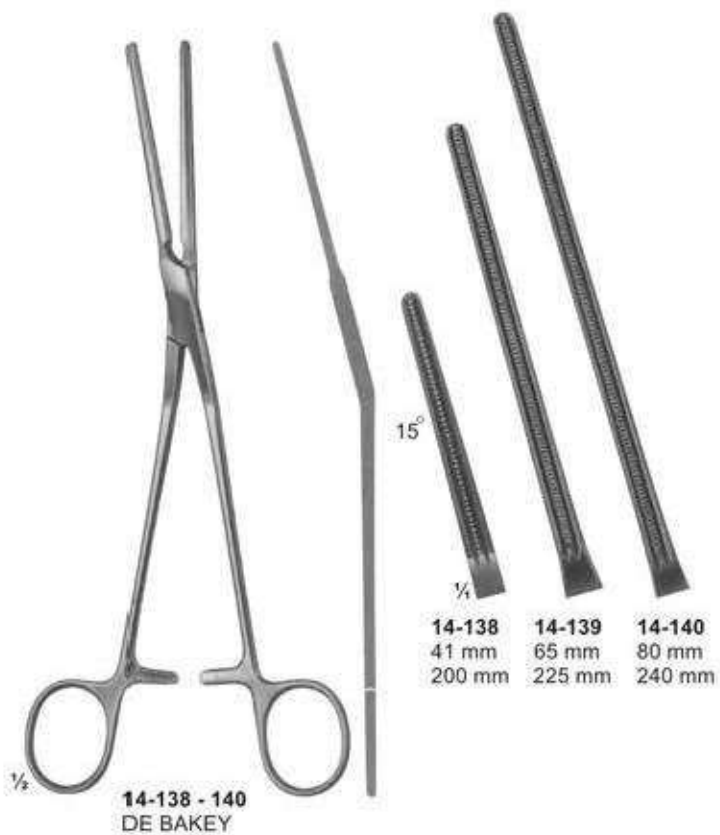



L
14-144
WEBER
260 mm



R
14-145
WEBER
260 mm

Multi- Purpose-Clamps



14-146 - 149
DE BAKEY



Total Length:	230 mm	280 mm	305 mm	240 mm
Length of jaws:	85 mm	100 mm	135 mm	93 mm



14-150 - 153
DE BAKEY

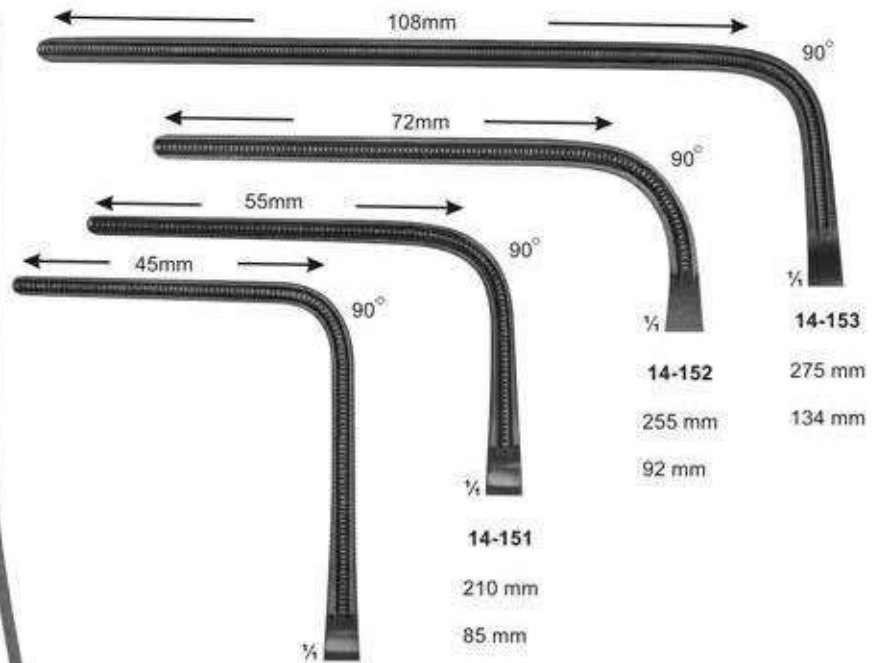

Total Length:	225 mm
Length of jaws:	93 mm



14-154
SCHUMACHER
 Sternum shears
 210 mm



14-155
LEBSCHÉ
 Sternum chisel
 200 mm



14-156
 230 mm



14-157
COLLIN
 195 mm



14-158
GLUCK
 190 mm



14-159
BETHUNE
 340 mm



14-160
BRUNNER
 Universal pattern
 340 mm



14-161
GIERTZ-STILLÉ
 250 mm



14-162
FINOCHIETTO
Blades
18X21 mm

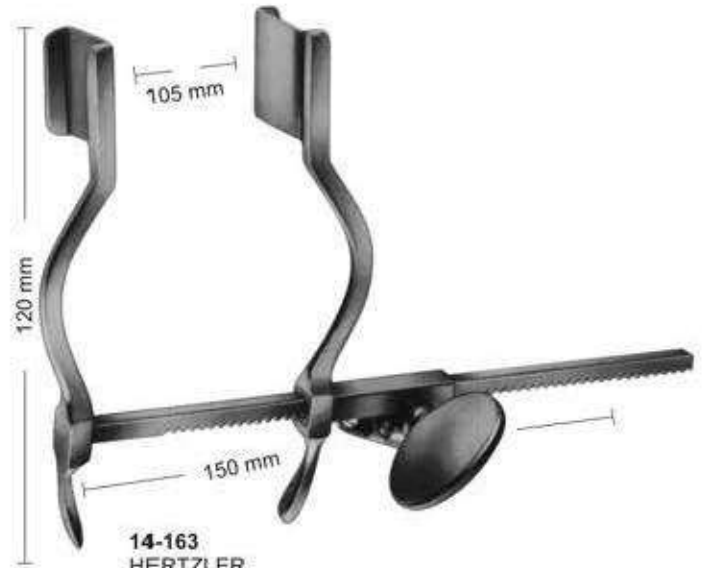

14-163
HERTZLER
Blades
20X25 mm

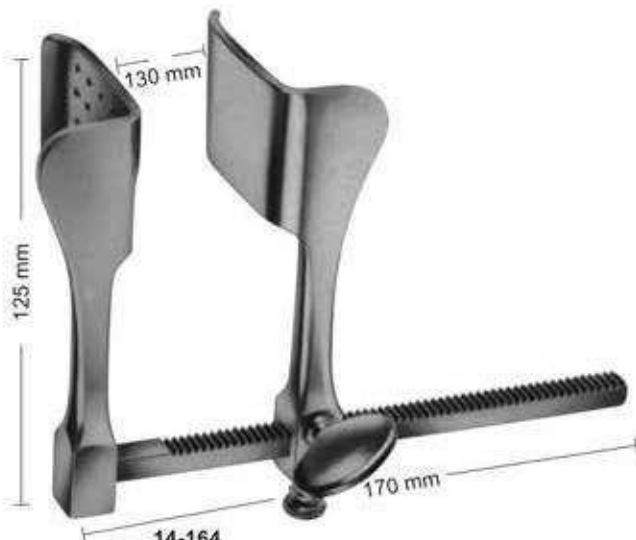

14-164
TUFFIER
Blades
43X53 mm

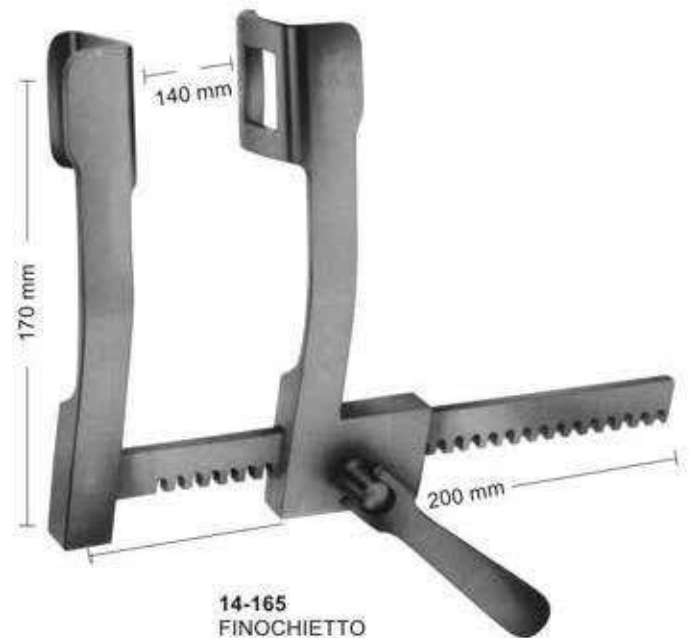

14-165
FINOCHIETTO
Blades
36X45 mm



14-166
SELLORS
Rib spreader-and contractor
with swivel blades
200 mm



14-167
BAILEY
150 mm



14-168
for children

14-169
for adults

14-168 - 169
BAILEY
200 mm

130° upwards cutting

15-101
1 mm

KERRISON - JACOBY

FERRIS-SMITH-KERRISON

15-102
2 mm

15-103
3 mm

15-104
4 mm

15-105
5 mm

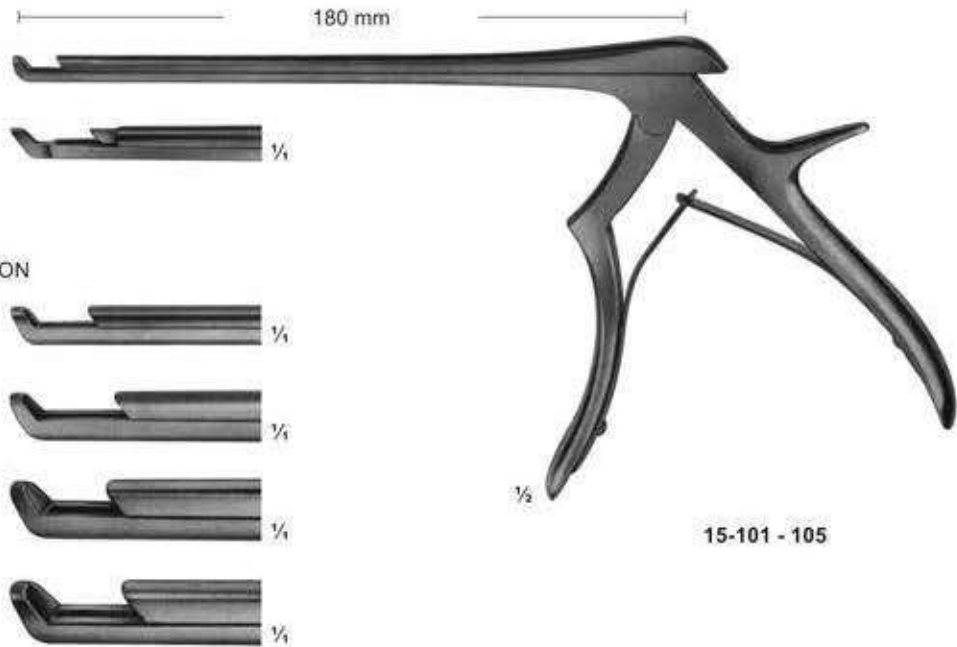

15-101 - 105

90° upwards cutting

KERRISON - JACOBY

15-106
1 mm

15-107
2 mm

FERRIS-SMITH-KERRISON

15-108
3 mm

15-109
4 mm

15-110
5 mm

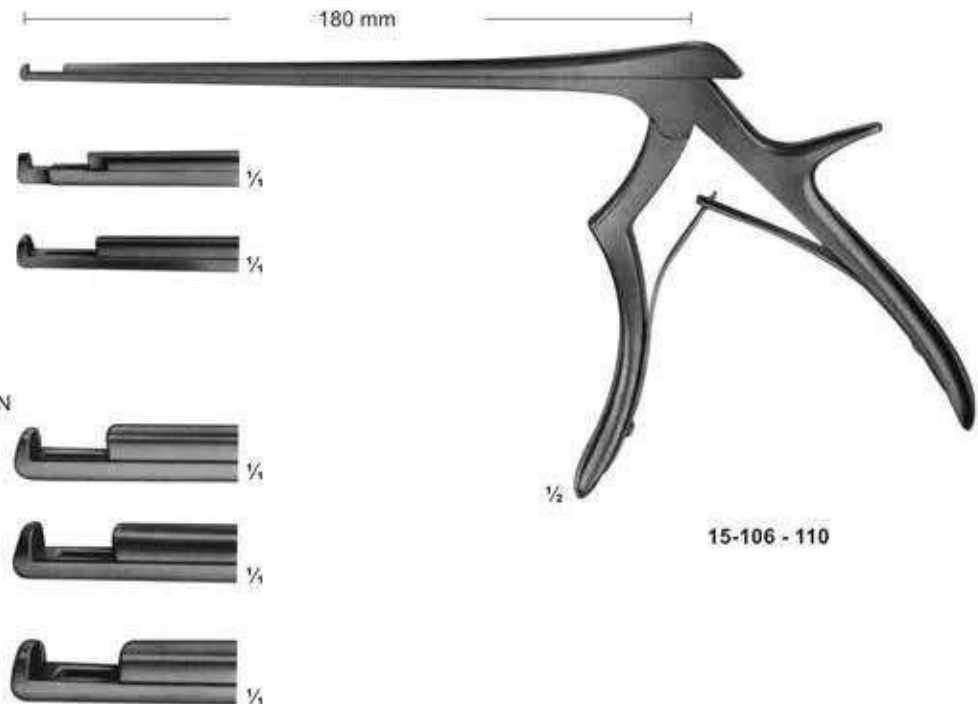

15-106 - 110

90° upwards cutting



15-111
4 mm



1/4

15-112
5 mm



1/4

1/2

15-111 - 15-112
KERRISON

90° upwards cutting

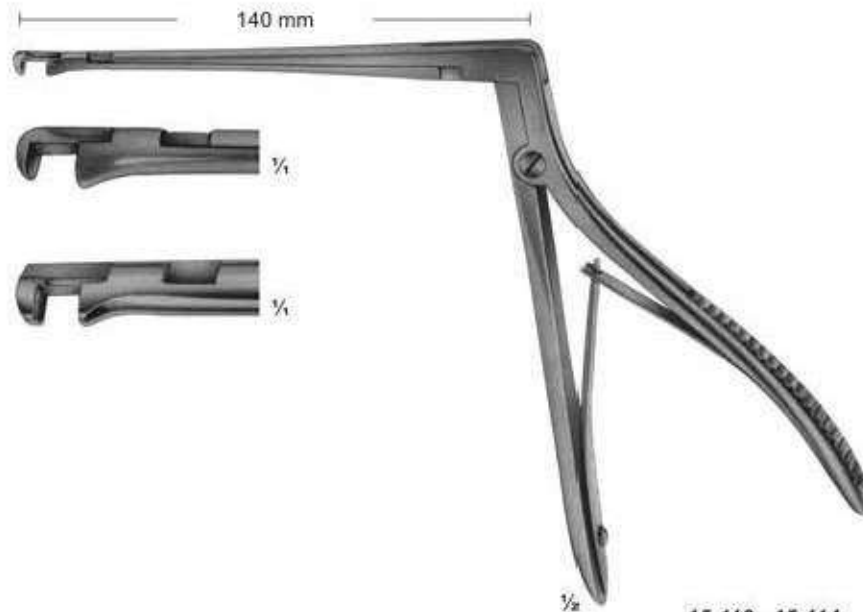

15-113
3,3 mm



1/4

15-114
4,0 mm



1/4

1/2

15-113 - 15-114
HAJEK-KOFLER

LOVE-GRUENWALD

15-115
2 X 10 mm

15-116
3 X 10 mm

SPURLING
15-117
4 X 10 mm



15-115 - 15-117

15-118
2 mm

15-119
3 mm

15-120
4 mm

15-121
5 mm

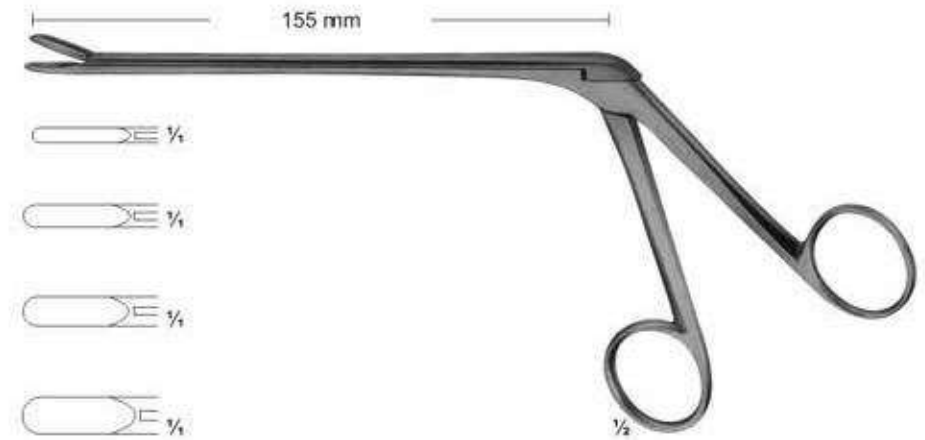

15-118 - 15-121
CASPAR

150°

15-122
2 mm

15-123
3 mm

15-124
4 mm

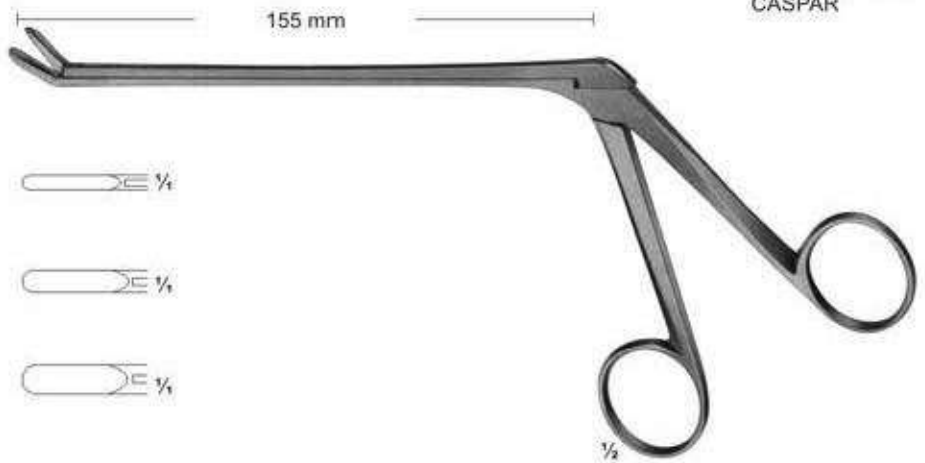

15-122 - 15-124
CASPAR

Angled positions for rongeurs

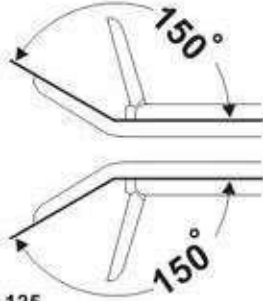

15-125
3,0 mm

15-126
3,6 mm

15-127
4,2 mm

15-128
4,8 mm

15-129
5,8 mm

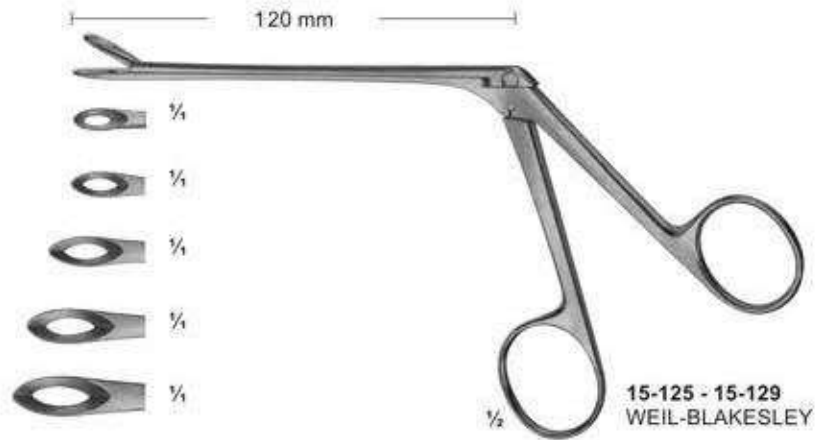
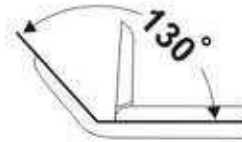
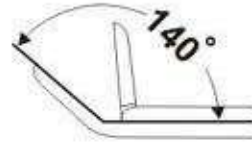

130°

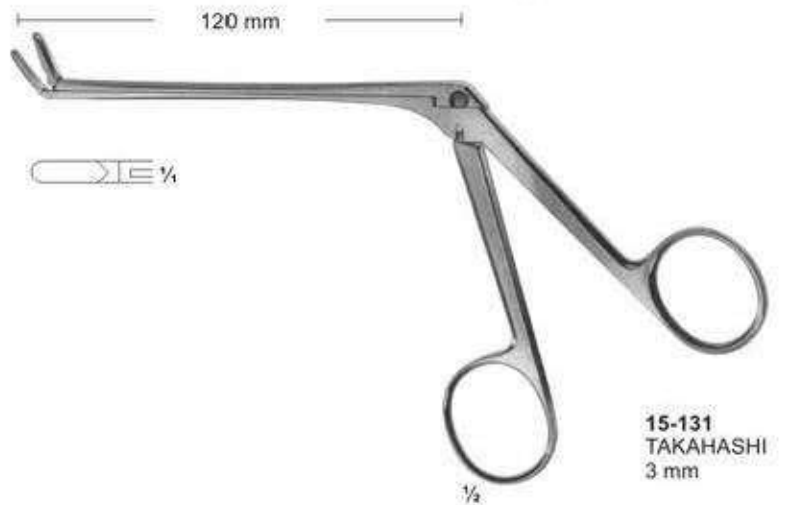

150°

Lower part of jaws movable

15-132
2 mm

15-133
3 mm

15-134
4 mm



15-132 - 15-134
CASPAR

Length of shaft
140 mm

Length of shaft
160 mm

Length of shaft
185 mm

size of jaws

15-135

15-140

15-145

2 X12 mm

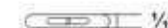

15-136

15-141

15-146

3 X12 mm



15-137

15-142

15-147

4 X14 mm

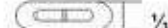

15-138

15-143

15-148

5 X14 mm



15-139

15-144

15-149

6 X16 mm



15-135 - 15-149
CASPAR

150°

Length of shaft
140 mm

Length of shaft
160 mm

Length of shaft
185 mm

size of jaws

15-150

15-153

15-156

3 X12 mm



15-151

15-154

15-157

4 X14 mm

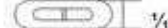

15-152

15-155

15-158

5 X14 mm

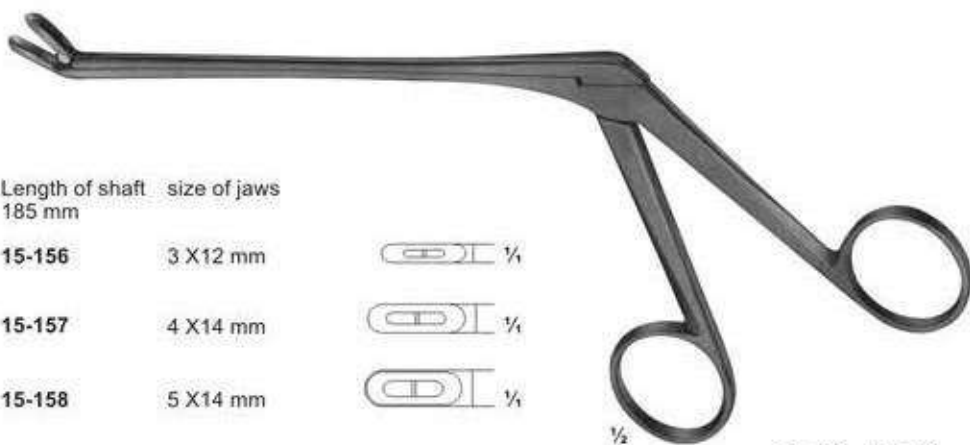

15-150 - 15-158
CASPAR

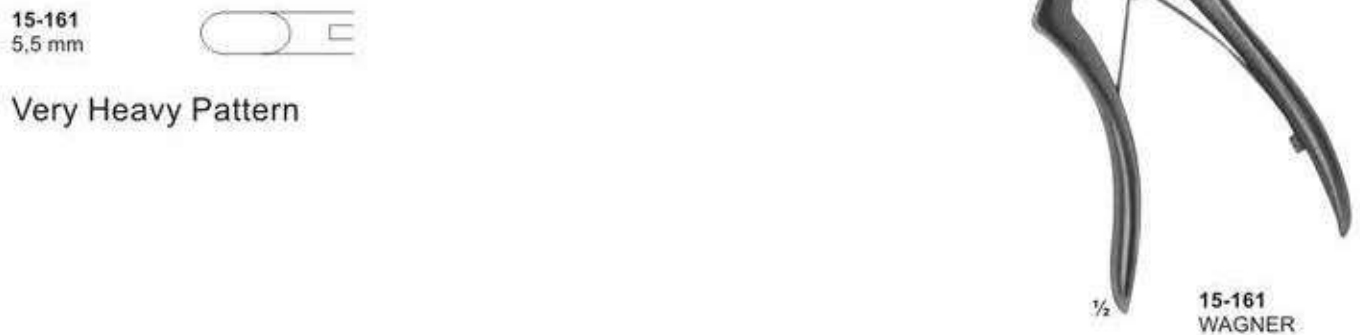
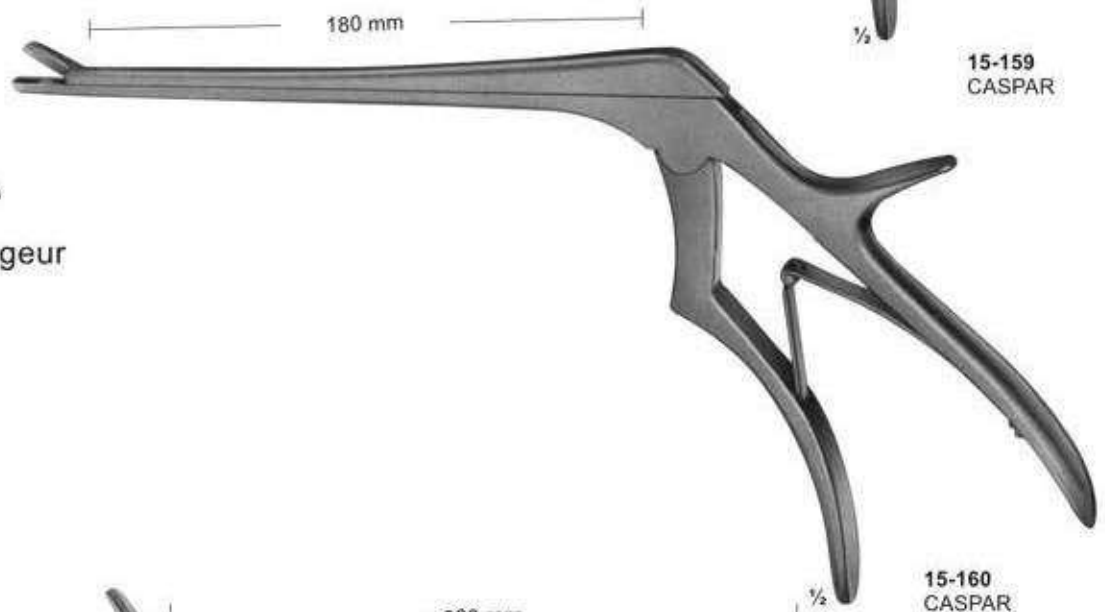
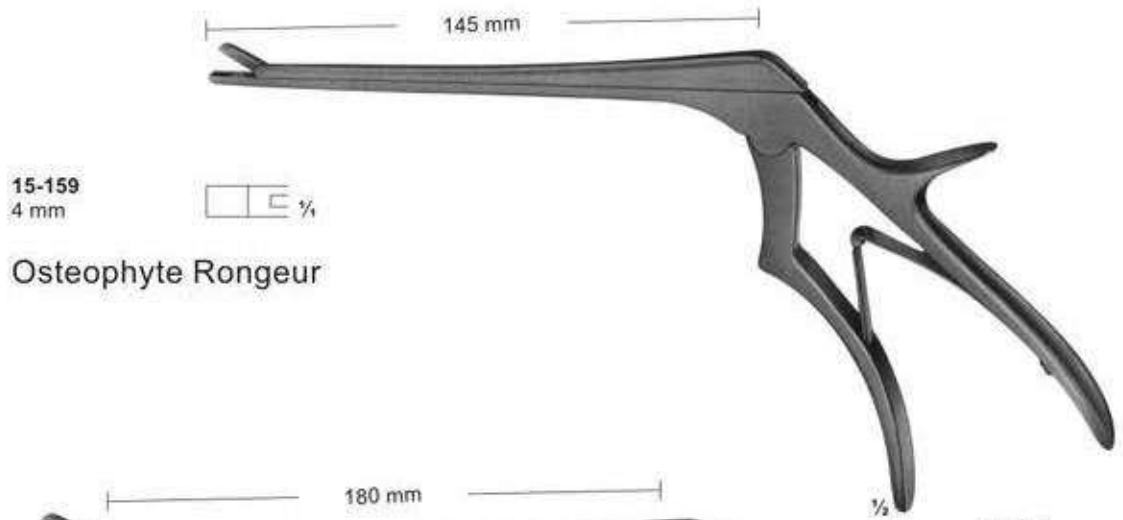

Elevators and Bone Levers

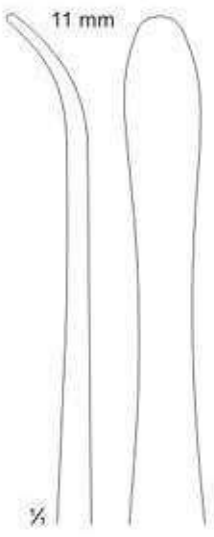
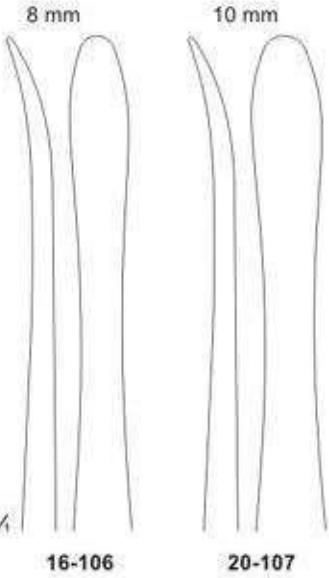
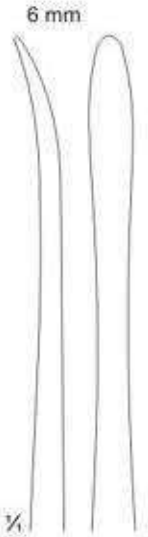
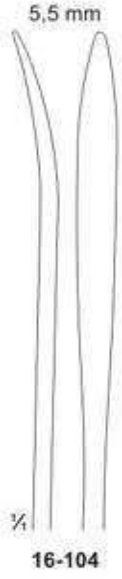
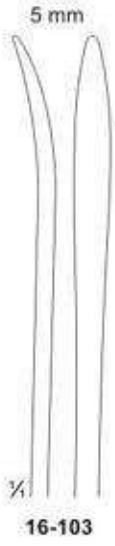
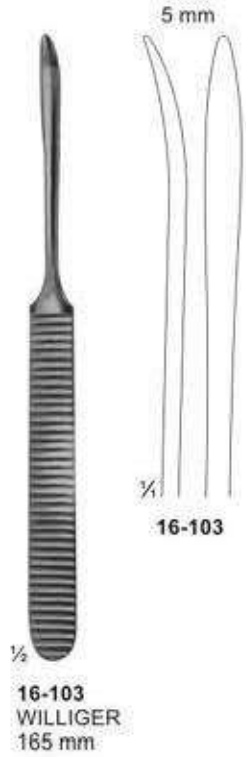
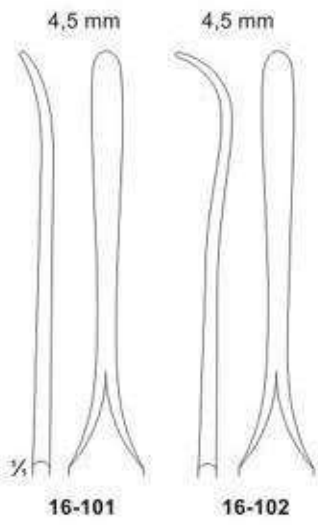



16-109
 LANE TRETHOWAN
 215mm



16-110
 LANE
 255mm



16-111
 LANGE-HOHMANN
 250mm



16-112 - 113
 LANGE-HOHMANN modif.
 16-112 265mm
 16-113 280mm

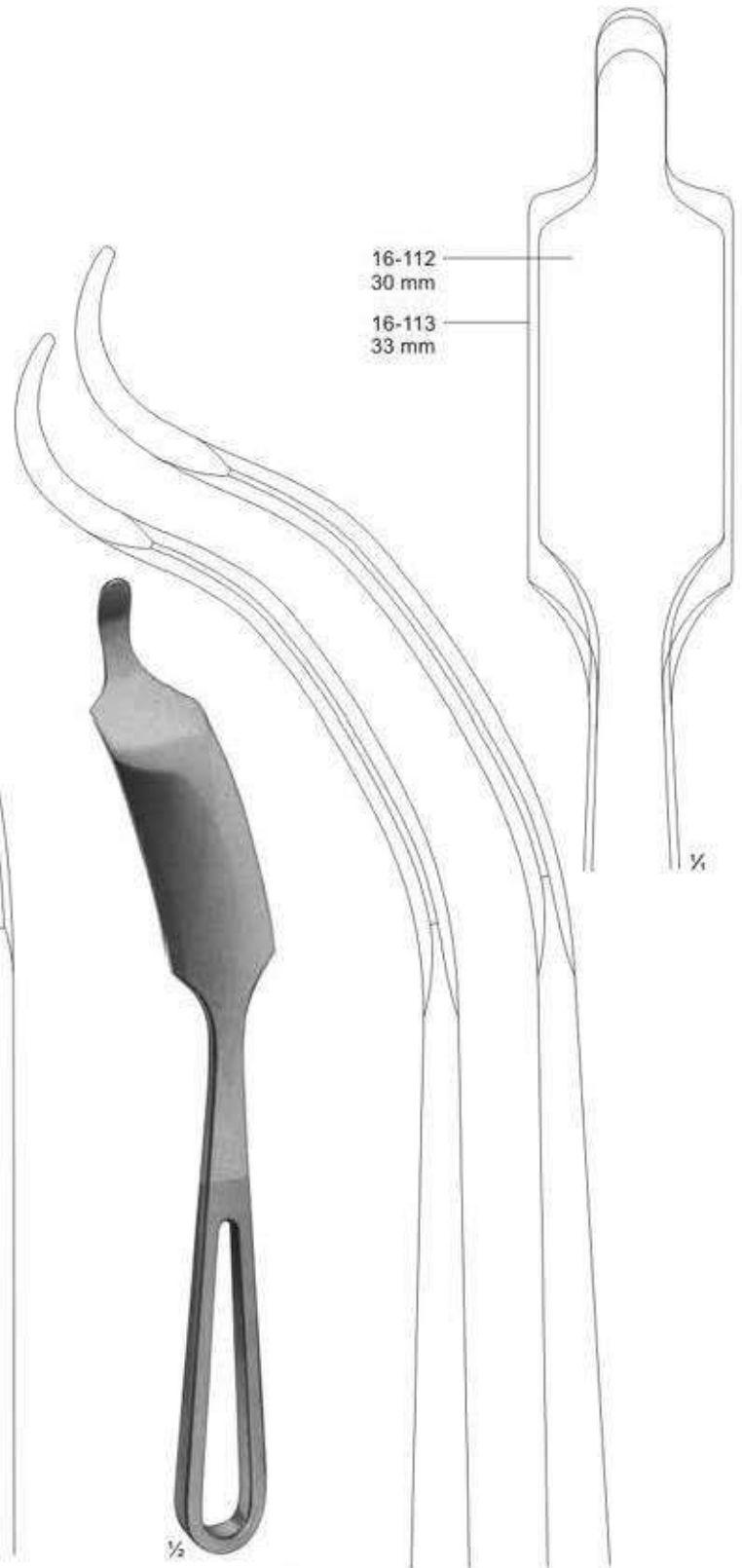

16-112
 30 mm
 16-113
 33 mm



16-114
PARTSCH
150 mm



16-116
PARTSCH mod. LANGE
145 mm



16-117
MC KENTY
155 mm

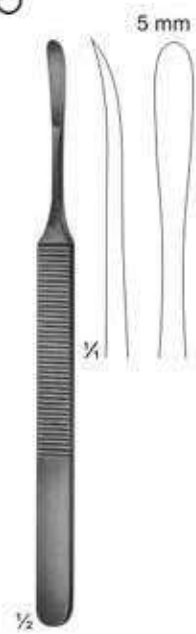

16-118
KOENIG
155 mm

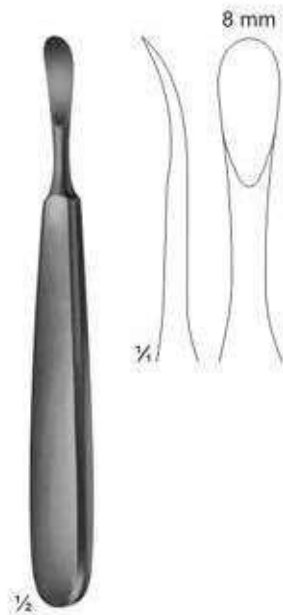

16-119
TRELAT
150 mm



16-120
WILLIGER
140 mm



16-121
WILLIGER
160 mm

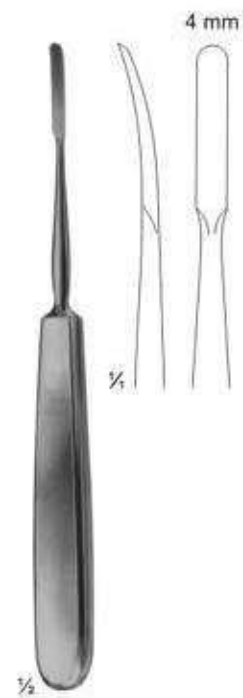

16-122
JOSEPH
170 mm

Bone File and Rasps

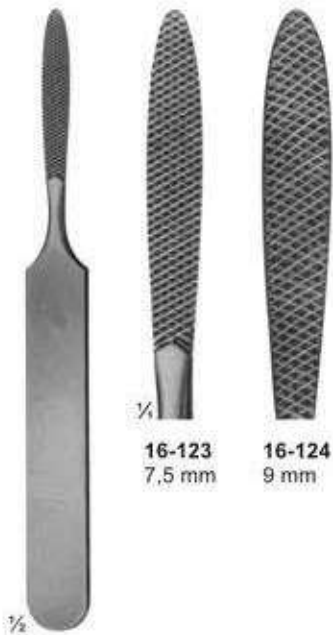

16-123
7,5 mm

16-124
9 mm

16-123
JOSEPH
fine, chequered

16-124
coarse, chequered
165 mm

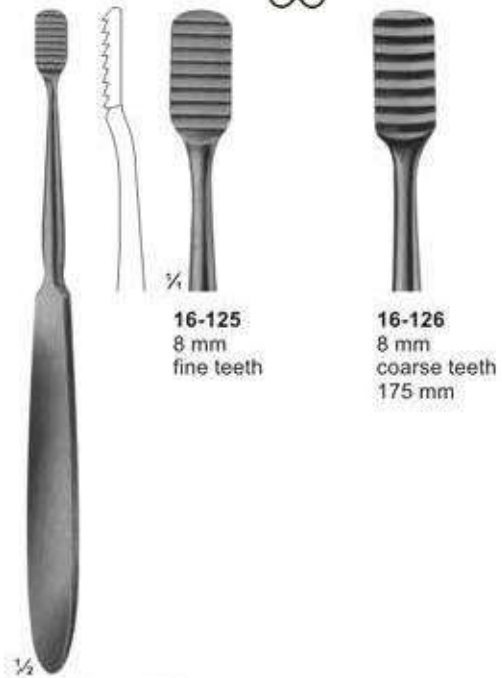

16-125
8 mm
fine teeth

16-126
8 mm
coarse teeth
175 mm

16-125 - 16-126
LEWIS



16-127
MALTZ
down stroke
180 mm

16-129
9 mm

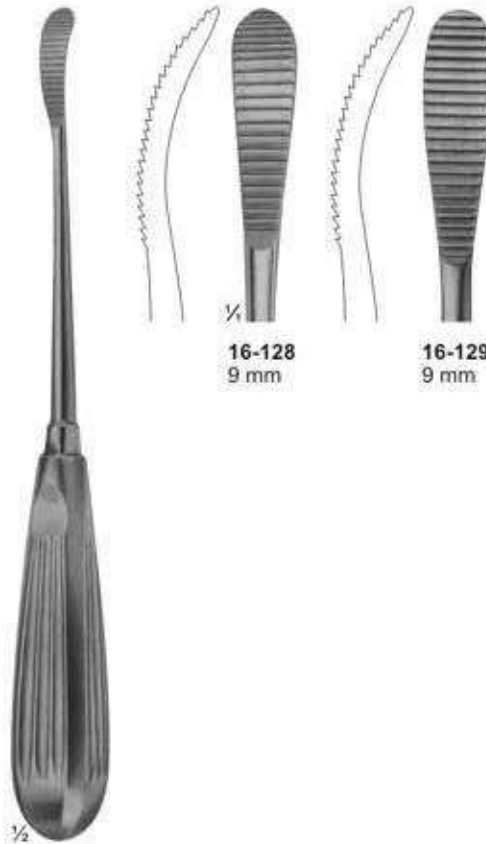

16-128
9 mm

16-129
9 mm

16-128 - 16-129
AUFRICT
up stroke
16-129
down stroke
220 mm



16-130
GALLAHER
190 mm

16-130
6,5 mm



16-131
JACOBSON
140 mm



16-132
MARTINI
140 mm



16-133
MARTINI
140 mm



16-134
WILLIGER
145 mm



16-135
JANSEN
160 mm



16-136
BARTH
180 mm



16-137
VOLKMANN
130 mm



16-138
VOLKMANN
145 mm

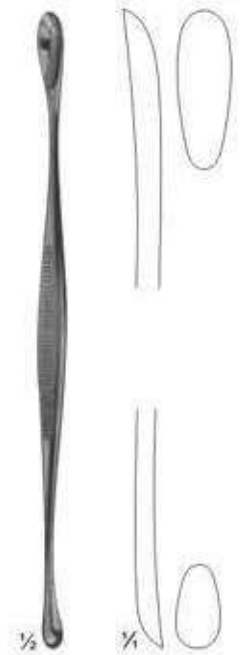

16-139
VOLKMANN
170 mm

Mallets Weights refer to the heads of the mallets
Hammer Die Gewichtsangaben beziehen sich auf den Kopf des jeweiligen Hammers



17-101
MEAD
 185 g
 with interchangeable
 plastic disks
 190 mm
17-102
 pair of spare disks



17-103
 140 g
 with interchangeable
 plastic disks
 185 mm
17-104
 pair of spare disks



17-105
COTTLE
 140 g
 1 Side Flat
 1 Side convex
 185 mm



17-106
 165 g
 lead filled head
 190 mm



17-107
MANNERFELT
Gouge
155 mm



17-108 - 112
Osteotomes
140 mm



17-113 - 117
Chisels
140 mm



17-118 - 122
Gouges
140 mm



PARTSCH
17-123 - 126
Chisels
140 mm

17-108 4 mm
17-109 6 mm
17-110 8 mm
17-111 10 mm
17-112 12 mm

17-113 4 mm
17-114 6 mm
17-115 8 mm
17-116 10 mm
17-117 12 mm

17-118 4 mm
17-119 6 mm
17-120 8 mm
17-121 10 mm
17-122 12 mm

17-123 3 mm
17-124 4 mm
17-125 5 mm
17-126 6 mm



PARTSCH
17-127 - 131
Chisels
170 mm



PARTSCH
17-132 - 135
Gouges
140 mm



PARTSCH
17-136 - 140
Gouges
170 mm



LUCAS
17-141 - 142
Chisels
160 mm



LUCAS
17-143 - 144
Gouges
160 mm

17-127 3 mm
17-128 4 mm
17-129 5 mm
17-130 6 mm
17-131 7 mm

17-132 3 mm
17-133 4 mm
17-134 5 mm
17-135 6 mm

17-136 3 mm
17-137 4 mm
17-138 5 mm
17-139 6 mm
17-140 7 mm

17-141 4 mm
17-142 6 mm

17-143 3 mm
17-144 5 mm



17-145
Patella forceps
185 mm



17-146
Forceps with
ratchet fixation
140 mm



17-147
Forceps with
thread fixation
170 mm



17-148
Forceps with
thread fixation
235 mm

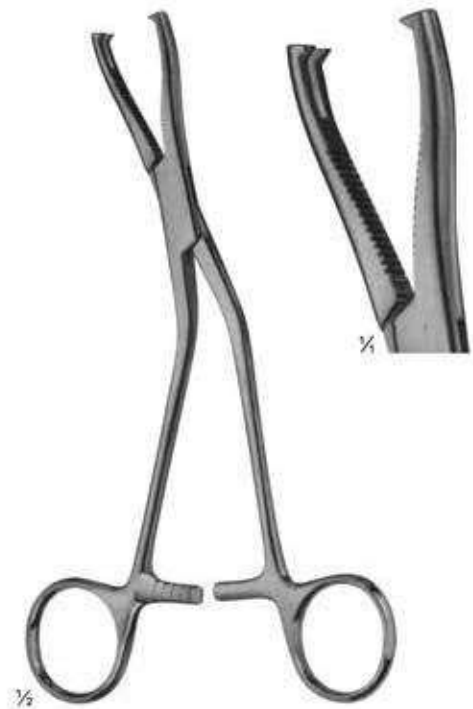

17-149
DINGMANN
185 mm

Bone Holding Forceps & Bone Clamps





17-158
LUER
150 mm



17-159
LUER
155 mm



17-160
BLUMENTHAL
155 mm



17-161
BLUMENTHAL
150 mm



17-162 - 163
JANSEN
175 mm



17-164
BANE-HARTMANN
175 mm



17-165
STILLE
235 mm



17-166
LEKSELL-STILLE
240mm



17-167
STILLE-RUSKIN
240mm

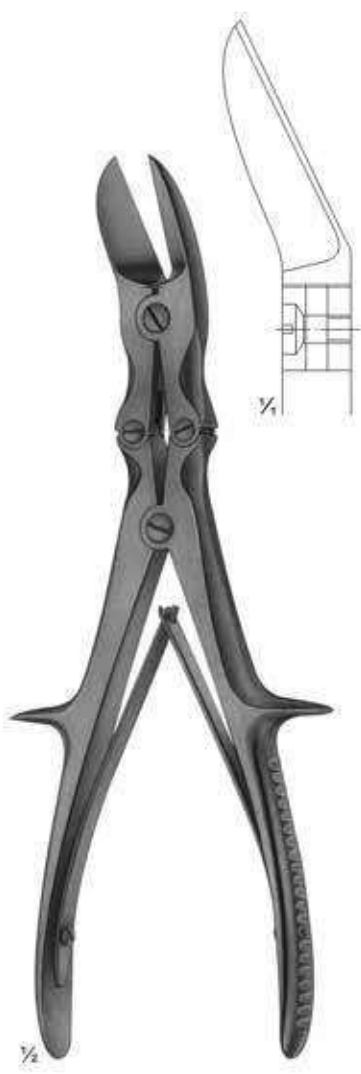

17-168
LISTON
curved on flat
240 mm

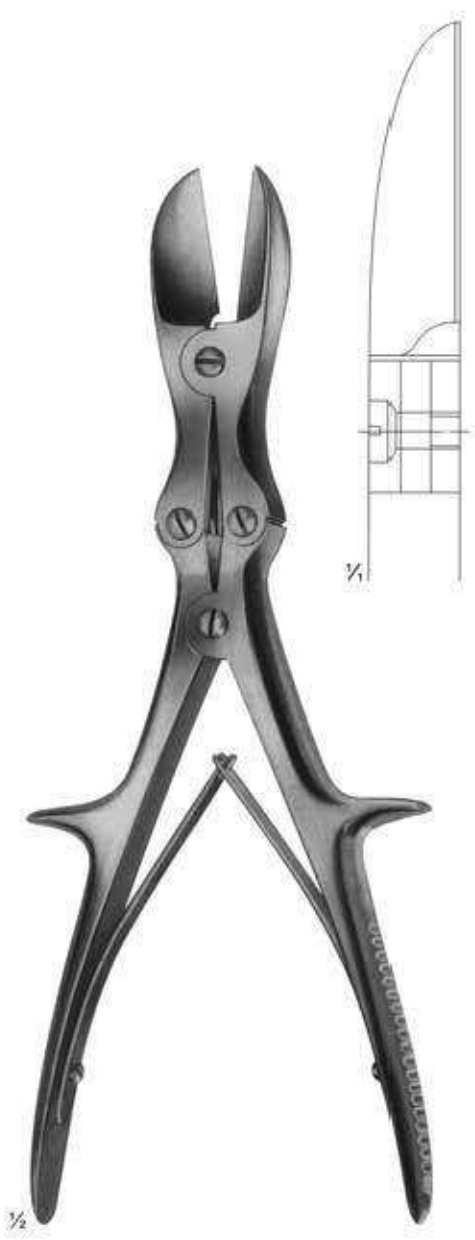

17-169
LISTON
straight
280 mm

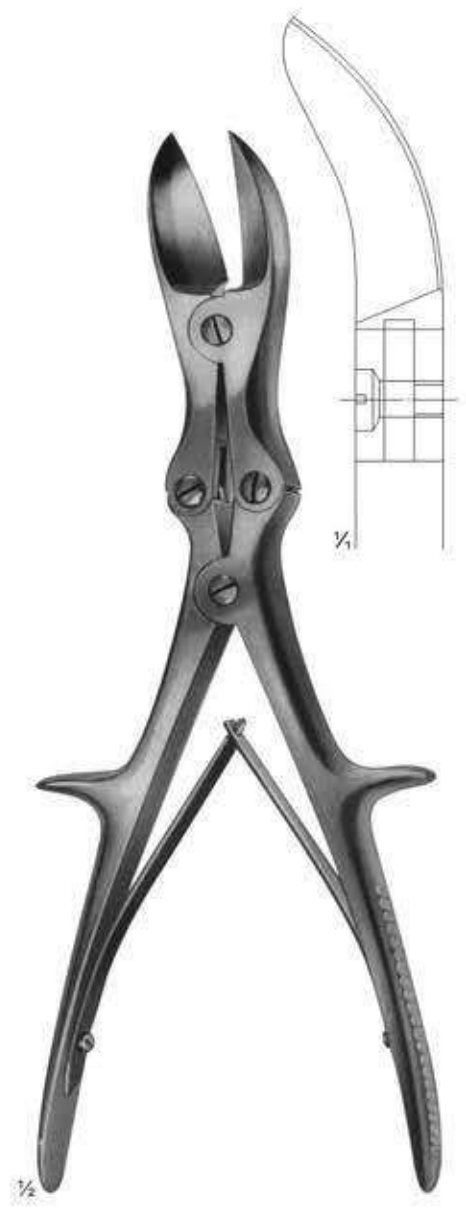

17-170
LISTON
curved on flat
280 mm

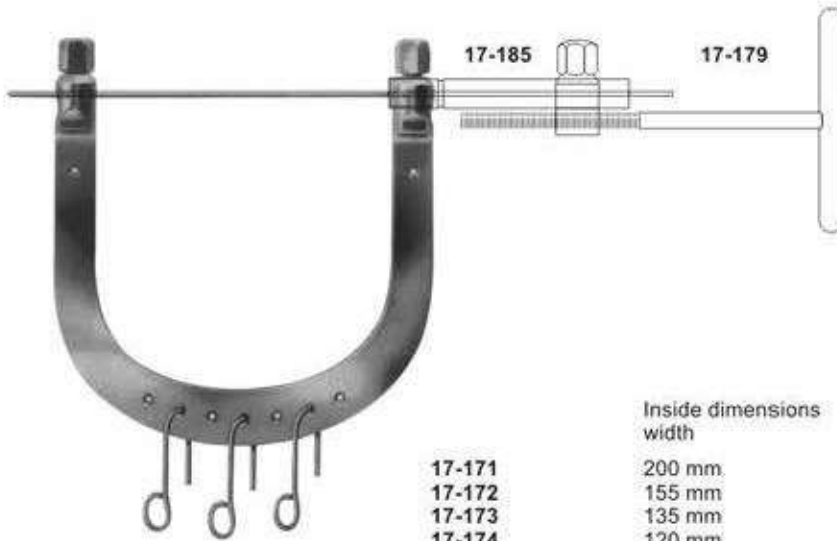

17-171 - 17-177
KIRSCHNER
 Wire traction bows,
 to be used with
 KIRSCHNER-wires
 up to 2.5 mm diam.,
 With 3 hooks,
 stainless steel

	Inside dimensions width	depth	
17-171	200 mm	155 mm	for the hip
17-172	155 mm	155 mm	for the femur
17-173	135 mm	130 mm	for the knee
17-174	120 mm	120 mm	for the knee
17-175	105 mm	100 mm	for the knee
17-176	95 mm	110 mm	for the calcaneus
17-177	95 mm	70 mm	for the arm and elbow



17-178
 Wrench, double - ended,
 for wire traction bows



17-179
 Wire tightener, with
 clamping jaws



17-182	max. 105 mm
17-183	max. 160 mm
17-184	max. 200 mm
17-182	80-95 mm
17-183	90-120 mm
17-184	140-170 mm
diam upto	
17-182	1,6 mm
17-183	2,0 mm
17-184	2,5 mm

17-182 - 17-184
KIRSCHNER
 Wire traction bows, modified,
 adjustable in width, holds wire
 securely, with 1 hook



17-180
 Traction hook only,
 large size



17-181
 Traction hook only,
 small size



17-185
 Fixation clamp, to secure clamping
 jaws of **17-179** stainless steel

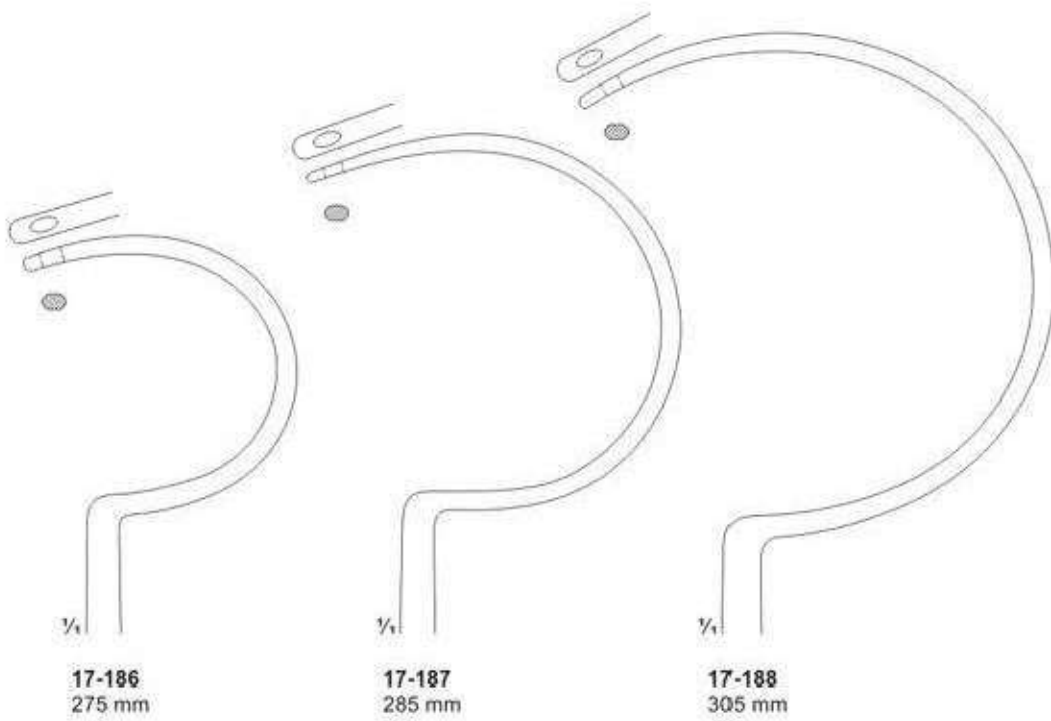

17-186 - 17-188
DEMEL
Wire guides

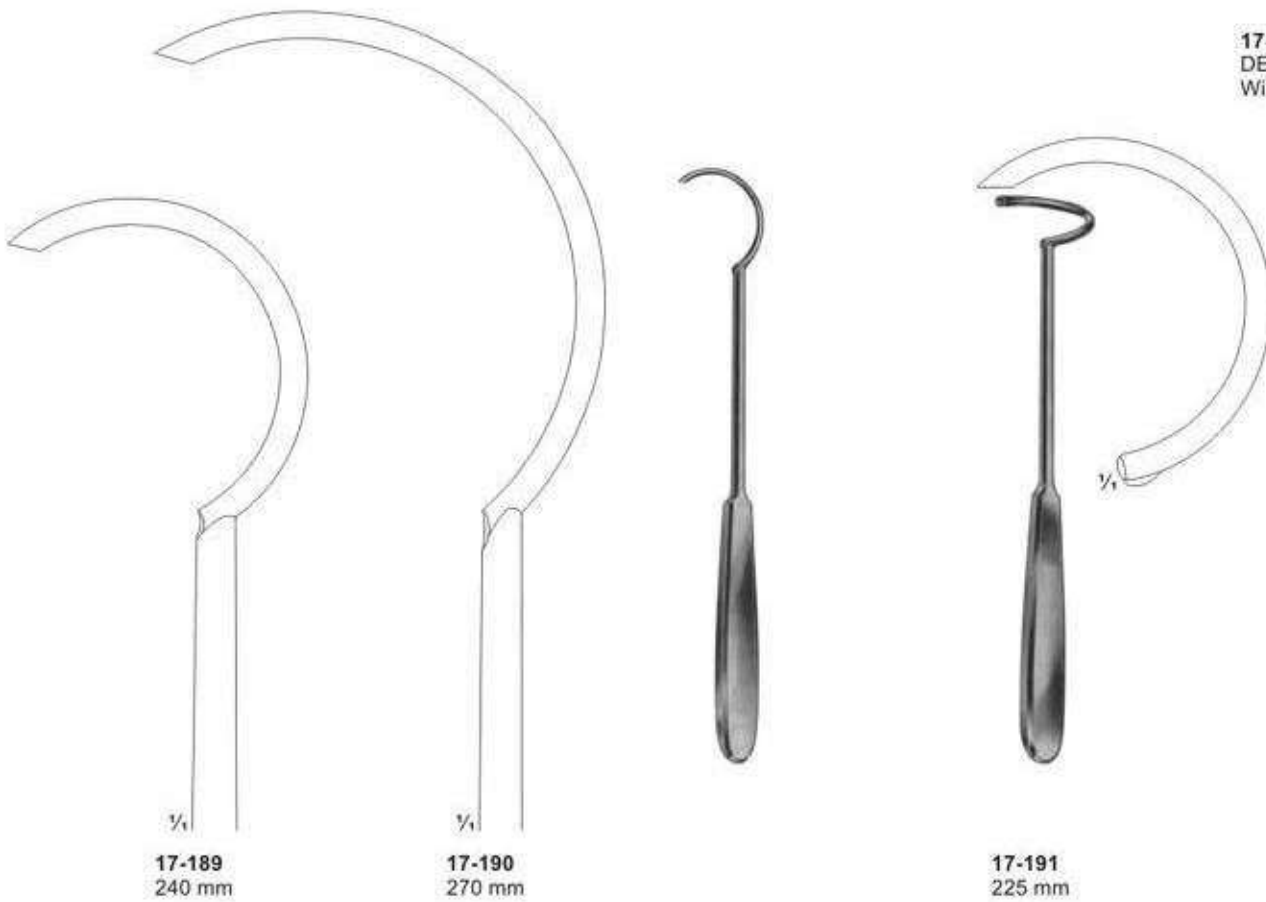

Wire Holding forceps, Wire Tightening Pliers, Flat-nosed Pliers DUROGRIP with Hard Metal Inserts



17-192
DUROGRIP
Holding forceps for cerclage
wire, with lateral jaws to avoid
wire slipping off
170 mm



17-193
DUROGRIP
Wire, tightening pliers.
Ligature pliers
150 mm



17-194
DUROGRIP
Wire, tightening pliers.
Ligature pliers
150 mm



17-195
with serrated jaws
140 mm



17-196
one jaw smooth,
one jaw serrated
140 mm



17-197
with serrated jaws
17-198
with longitudinal and
transversal grooves
170 mm



17-199
190 mm

Wire Holding forceps, Flat-nosed Pliers, Pliers for bending and cutting wires



17-200 - 17-201
Extraction pliers
for boring wires



17-202
Flat-nosed pliers,
parallel
185 mm



17-203
Vise grip
200 mm

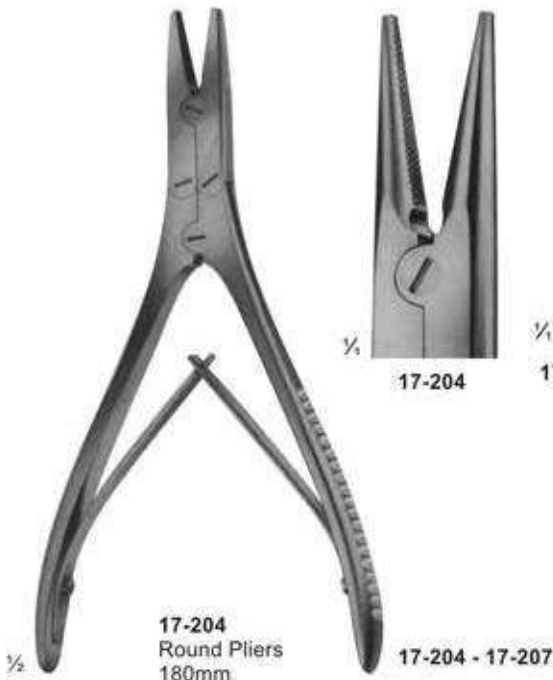

17-204
Round Pliers
180mm

17-204 - 17-207

17-205 145 mm
17-206 180 mm
17-207 180 mm
Extraction pliers for wires



17-208
Bending pliers
for wires up to
1.8 mm diam.

Wire Cutters and wire Cutting Scissors DUROTIP with Carbide Cutting Edges



17-209
ANGLE
130 mm

for soft wire
up to diam.
for hard wire
up to diam.

0,5 mm
0,3 mm

17-210
DUROTIP
ANGLE
130 mm

0,6 mm
0,4 mm

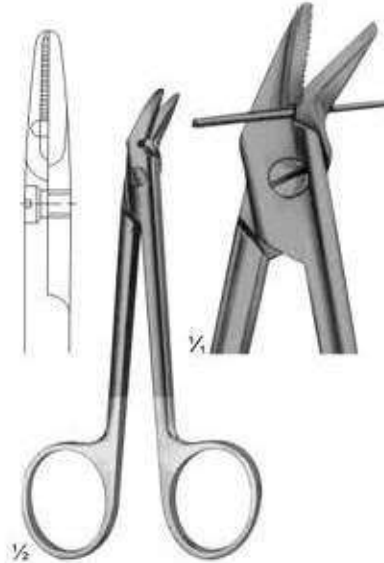

17-211
120 mm

for soft wire
up to diam.
for hard wire
up to diam.

1,2 mm
0,8 mm

17-212
DUROTIP
120 mm

1,2 mm
0,8 mm



17-213
HARVEY
125 mm

0,4 mm
0,3 mm



17-214
150 mm

for soft wire
up to diam
for hard wire
up to diam

1,5 mm
1,0 mm



17-215
160 mm

1,5 mm
1,2 mm



17-216
140 mm
DUROTIP
1,5 mm

1,0 mm



17-217
180 mm

for soft wire
up to diam. 2,0 mm
For hard wire 1,5 mm
up to diam
specially hardened
cutting edges, front
and lateral cutting
action



17-218
REILL
175 mm

for soft wire
up to diam. 2,0 mm
For hard wire 1,6 mm
up to diam
specially hardened
cutting edges, for
cutting off wires close
to the bone



DUROTIP

17-219
235 mm

for soft wire
up to diam. 3,0 mm
For hard wire 2,2 mm
up to diam

Wire Cutting Pliers, Lateral and Front Cutting Action



17-220
240 mm

for soft wire up to diam. 2,0 mm
For hard wire up to diam 1,6 mm



17-221
145 mm

for soft wire up to diam. 1,5 mm
For hard wire up to diam 1,0 mm



17-222
145 mm

for soft wire up to diam. 2,0 mm
For hard wire up to diam 1,5 mm

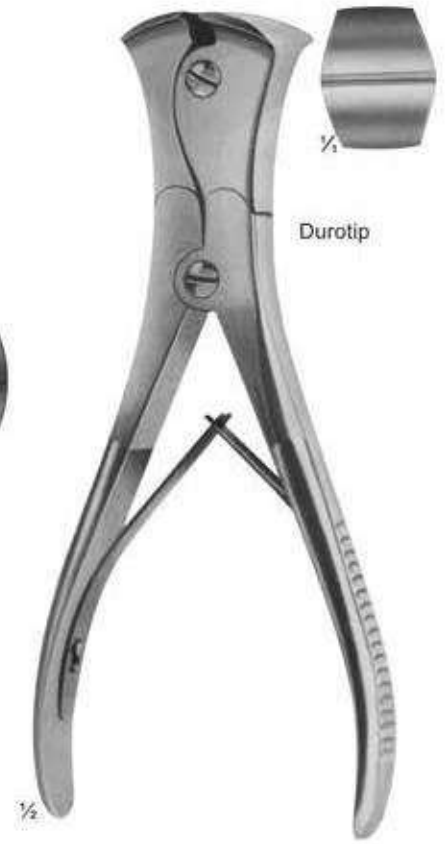

17-223
220 mm

for soft wire up to diam. 3,5 mm
For hard wire up to diam 2,5 mm



17-224
320 mm

for soft wire
up to diam. 3,0 mm
For hard wire
up to diam. 3,0 mm



Cutter for cutting off
KIRSCHNER wires,
Tibia head screws,
bolts, pins, up to 3 mm diam.



DUROTIP

17-225
Cutter for cutting off
KIRSCHNER wires,
Tibia head screws,
bolts, pins, up to 6 mm diam.
470 mm

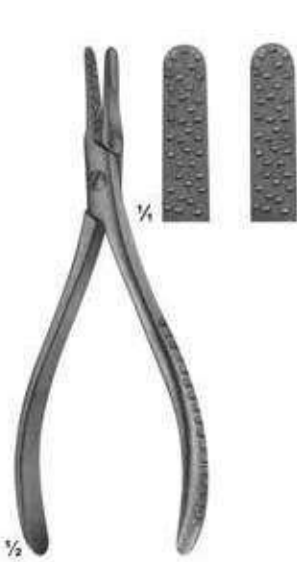

17-226
Nail extracting
forceps
135 mm



17-227
Nail extracting
forceps
145 mm



17-228
Finger nail drill
with 3 drill points

17-228 **17-229** **17-230**
Drill points only

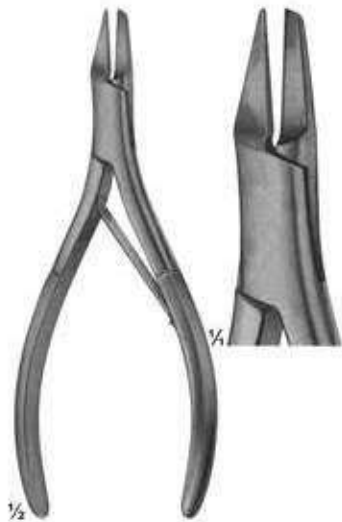

17-231
Nail splitting
forceps
135 mm



17-232
SYSTRUNK
Scissors, for splitting
finger nails
130 mm



17-233
Finger ring saw
150 mm

Spare blade
17-234



17-235
STILLE-AESFULAP
260 mm



17-236
STILLE-AESFULAP
360 mm



17-237
HENING
270 mm



17-238
MOD. USA
230 mm



17-239
290 mm



with removable jaws



17-240 - 17-241
WOLFF
17-240 180 mm
17-241 240 mm
plaster breakers

Vacuum Curettes for Aspiration Lipectomy, Suction Instruments

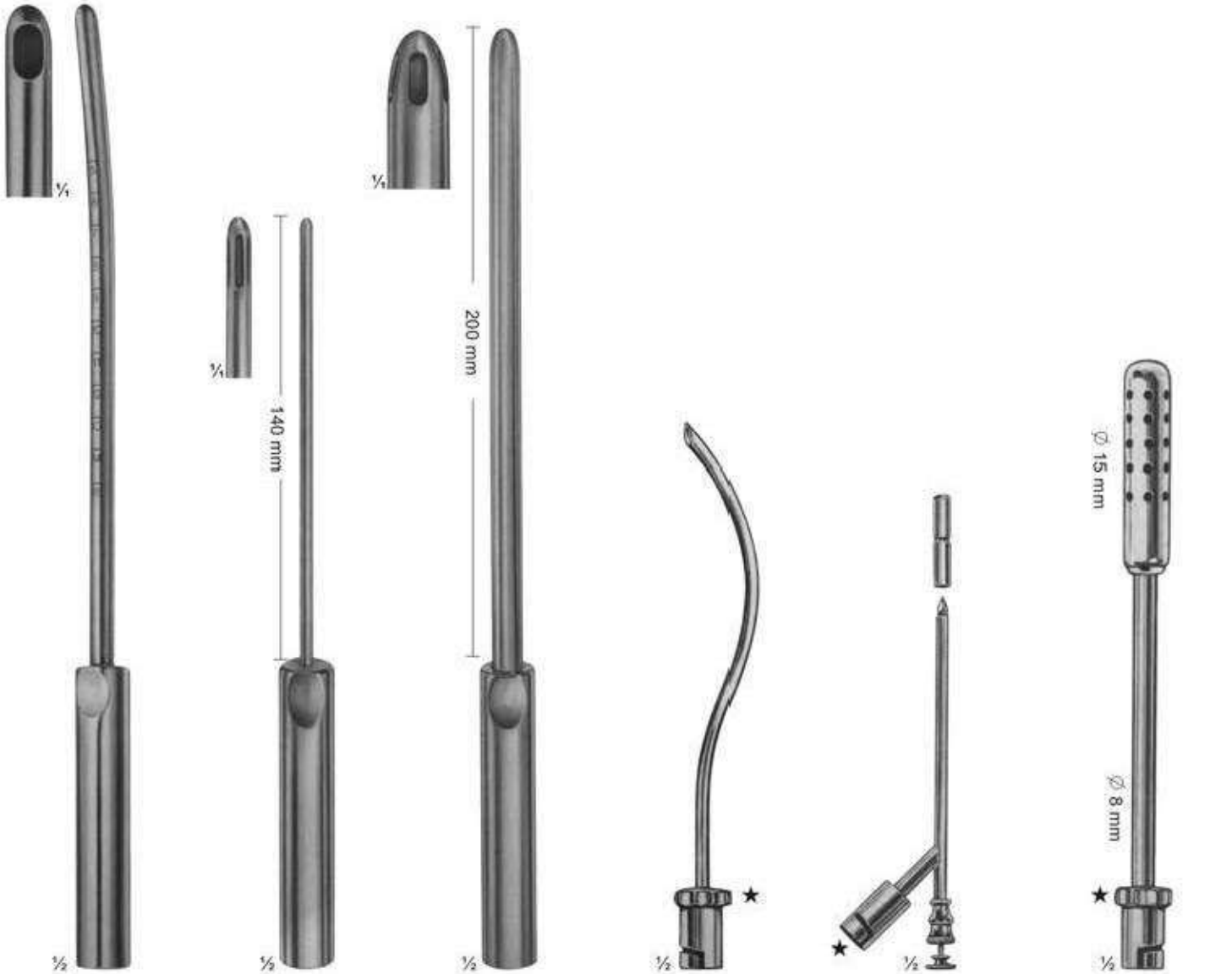

18-101 - 18-106
BIEMER
18-101 \varnothing 4 mm
18-102 \varnothing 6 mm
18-103 \varnothing 8 mm
18-104 \varnothing 10 mm
18-105 \varnothing 12 mm
18-106 \varnothing 14 mm
Curettes for aspiration lipectomy, graduated, slightly curved

18-107 - 18-108
BIEMER
18-107 \varnothing 4 mm
18-108 \varnothing 6 mm
Curettes for aspiration lipectomy, with three apertures, slightly curved malleable

18-109 - 18-111
BIEMER
18-109 \varnothing 8 mm
18-110 \varnothing 10 mm
18-111 \varnothing 12 mm
Curettes for aspiration lipectomy, with three apertures, slightly curved malleable

18-112
For aspirating fluid from the excretory ducts of large glands and for keeping the operating area clear 170 mm

18-113
Trocar
For puncturing 150 mm

18-114
For clearing large quantities of fluid 190 mm

18-115 150mm
Suction handle, with vacuum regulator and finger cut-off, brass, mirror-finish chromium-plated.



olive
Ø 9 mm

18-116 170mm
Suction handle, with hand regulation valve and quick-shutter, brass, mirror-finish chromium-plated



Both suction handles have bayonet fitting olive and can be used for the suction cannulae. Ø 9 mm



18-117
Trocar
For puncturing
170 mm



18-118
Hollow needle,
sharp
150 mm



18-119
double curved
For general
surgery
230 mm



18-120
For tonsillectomy,
oral and laryngeal
operations
190 mm



18-121
For tonsillectomy,
oral and laryngeal
operations
220 mm

★ With bayonet fitting to be used with suction handles (18-115 - 18-116)

18-122
WULLSTEIN
 Suction tube, conical, silver, olive
 with LUER hub
 160 mm

Ø 1,75 mm Ø 3 mm
 1/8" 1/8"

olive Ø 8 mm

18-123 1,5 mm
18-124 2,0 mm
WULLSTEIN
 Suction tube, cylindrical, silver, with
 stylet olive with LUER hub
 160 mm

olive Ø 8 mm

Usable length

YASARGIL usable length diam.			YASARGIL usable length diam.		
18-125	130 mm	1,5 mm	18-133	130 mm	2,5 mm
18-126	150 mm	1,5 mm	18-134	150 mm	2,5 mm
18-127	180 mm	1,5 mm	18-135	180 mm	2,5 mm
18-128	220 mm	1,5 mm	18-136	220 mm	2,5 mm
18-129	130 mm	2,0 mm	18-137	130 mm	3,5 mm
18-130	150 mm	2,0 mm	18-138	150 mm	3,5 mm
18-131	180 mm	2,0 mm	18-139	180 mm	3,5 mm
18-132	220 mm	2,0 mm	18-140	220 mm	3,5 mm
			18-141	180 mm	4,5 mm

olive
 Ø 6,5-9 mm
 with LUER hub

18-142 - 18-144
LANDOLT
 150 MM
 diam Ø 3 mm

18-142 8 mm / curved
18-143 11mm / curved
18-144 15mm / curved

Ø 3,5 mm Ø 2,0 mm

18-145 500 mm
18-146 350 mm
 with rubber tip,
 with LUER hub

olive Ø 9 mm
 1/4"

18-147 2,0 mm diam
18-148 2,5 mm diam
18-149 3,0 mm diam
 with finger cut-off,
 thumb piece 90° to
 curve, with LUER hub
 250 mm

olive Ø 6-9 mm
 1/4"

Combined Suction and Irrigation Cannulae, Coagulation Suction Cannulae

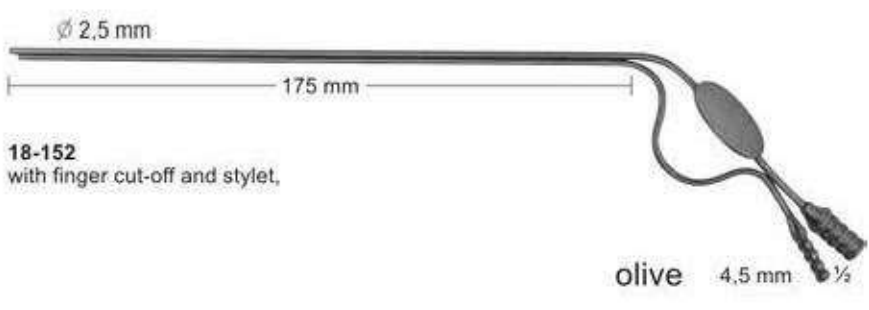

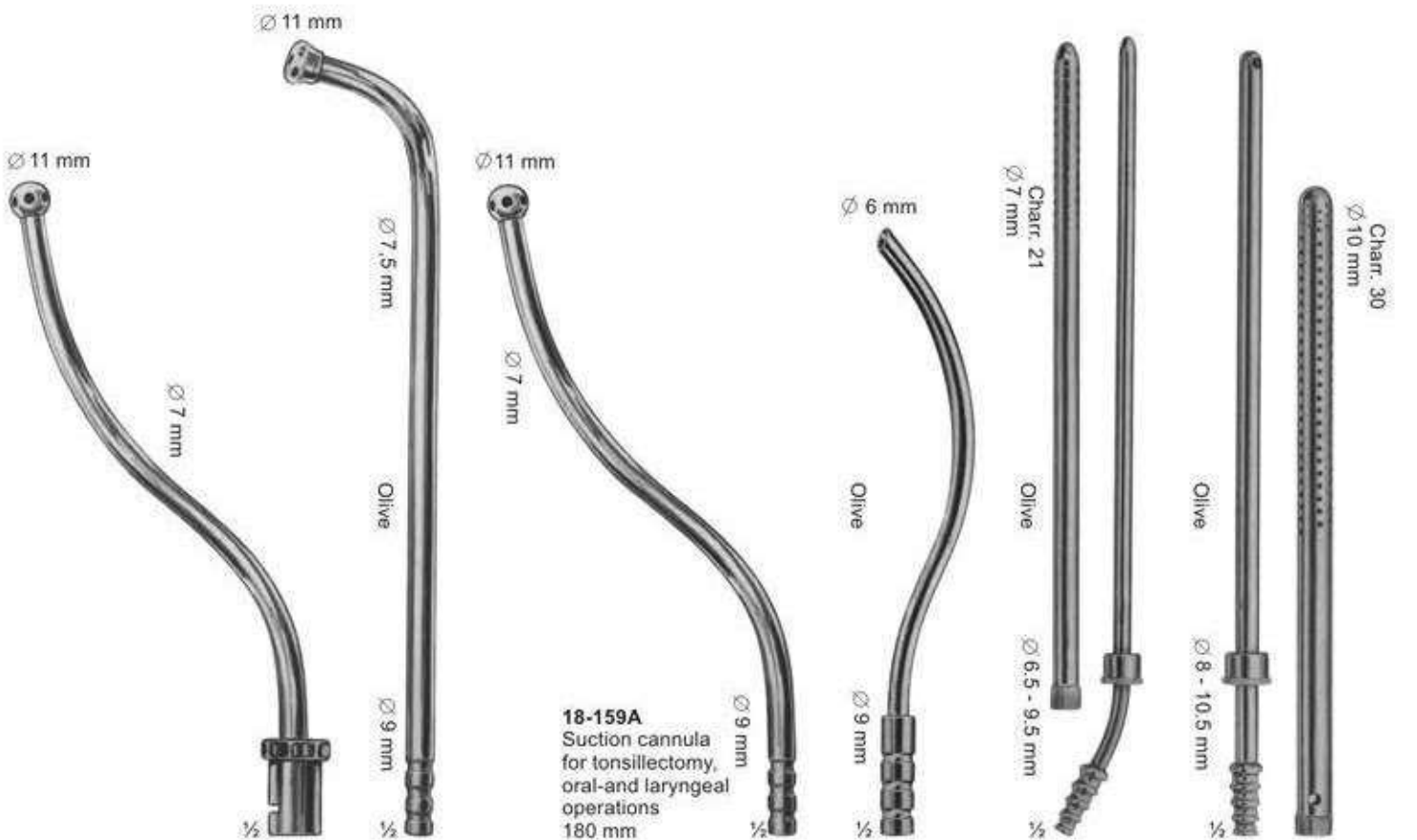

18-158
For tonsillectomy,
oral-and laryngeal
operations
180 mm

18-159
Suction cannula
for tonsillectomy,
oral-and laryngeal
operations
220 mm

18-159A
Suction cannula
for tonsillectomy,
oral-and laryngeal
operations
180 mm

18-160
S-shaped blunt cannula
for aspirating fluid from
the excretory ducts of
large glands and for
keeping the operating
area clear
170 mm

18-161
POOL
Suction cannula,
with outer tube
to be screwed of
225 mm

18-162
POOL
Suction cannula,
with outer tube
to be screwed off
225 mm

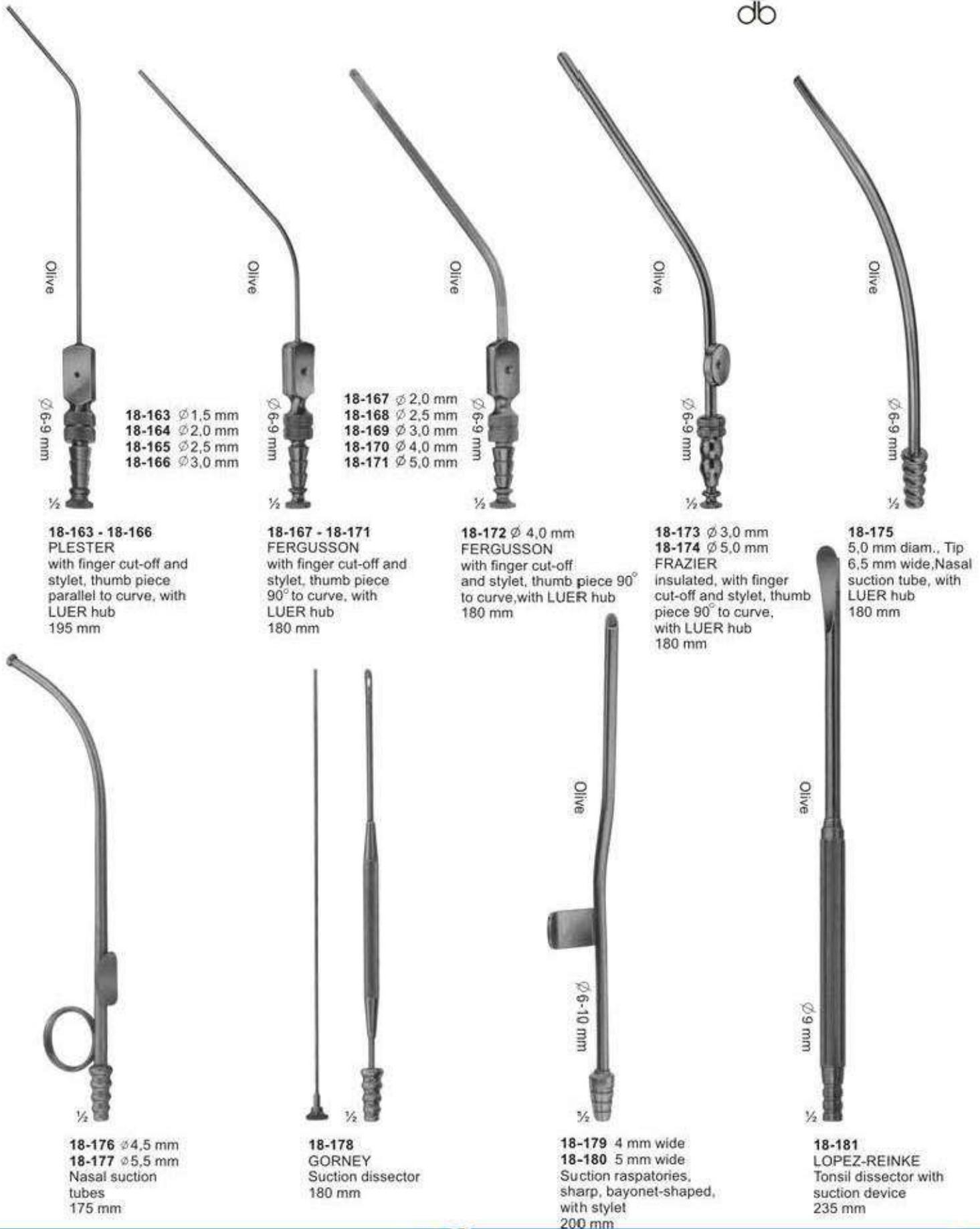

Olive

Ø 6-9 mm

- 18-163 Ø 1,5 mm
- 18-164 Ø 2,0 mm
- 18-165 Ø 2,5 mm
- 18-166 Ø 3,0 mm

18-163 - 18-166
PLESTER
 with finger cut-off and stylet, thumb piece parallel to curve, with LUER hub
 195 mm

Olive

Ø 6-9 mm

- 18-167 Ø 2,0 mm
- 18-168 Ø 2,5 mm
- 18-169 Ø 3,0 mm
- 18-170 Ø 4,0 mm
- 18-171 Ø 5,0 mm

18-167 - 18-171
FERGUSSON
 with finger cut-off and stylet, thumb piece 90° to curve, with LUER hub
 180 mm

Olive

Ø 6-9 mm

18-172 Ø 4,0 mm
FERGUSSON
 with finger cut-off and stylet, thumb piece 90° to curve, with LUER hub
 180 mm

Olive

Ø 6-9 mm

18-173 Ø 3,0 mm
18-174 Ø 5,0 mm
FRAZIER
 insulated, with finger cut-off and stylet, thumb piece 90° to curve, with LUER hub
 180 mm

Olive

Ø 6-9 mm

18-175
 5,0 mm diam., Tip 6,5 mm wide, Nasal suction tube, with LUER hub
 180 mm

18-176 Ø 4,5 mm
18-177 Ø 5,5 mm
 Nasal suction tubes
 175 mm

18-178
GORNEY
 Suction dissector
 180 mm

Olive

Ø 6-10 mm

18-179 4 mm wide
18-180 5 mm wide
 Suction raspatories, sharp, bayonet-shaped, with stylet
 200 mm

Olive

Ø 9 mm

18-181
LOPEZ-REINKE
 Tonsil dissector with suction device
 235 mm

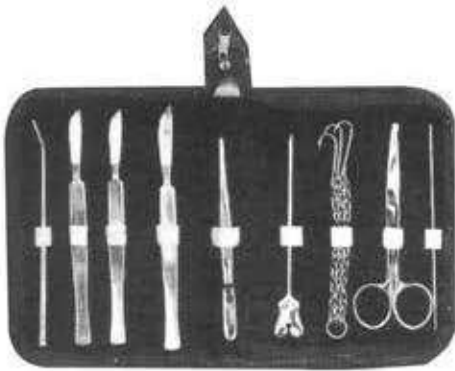

18-182

- 1- Blow pipe .
- 2- 3 PCS .scalpel.
- 3- Dissecting forcep 13 cm.
- 4- Grooved director with toungue tie 13 cm.
- 5- Triple chain hook.
- 6- Dressing scissors probe pointed 13 cm.
- 7- Probe double 13 cm.
- 8- Zipper case inside red velvet.

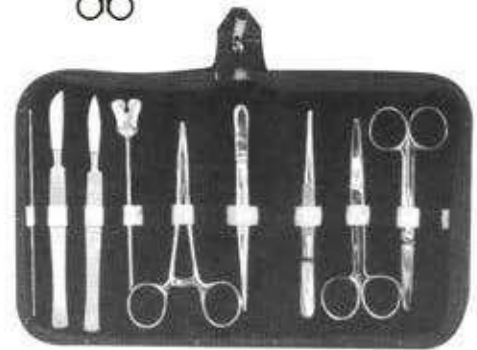

18-183

- 1- Probe Double 13 cm
- 2- 2 PCS. Scalpel S.S
- 3- Grooved Director With tongue Tie 13 cm
- 4- Mayo Hegar Needle Holder 13cm
- 5- Discting Forcep 13 cm 1x2 Teeth
- 6- Dressing Forcep 13 CMS Serrated.
- 7- Dressing Scissor 13 cm S/B STR.
- 8- Dressing Scissor 13 cm S/B CVD.
- 9- Zipper Case Inside Red Velvet.

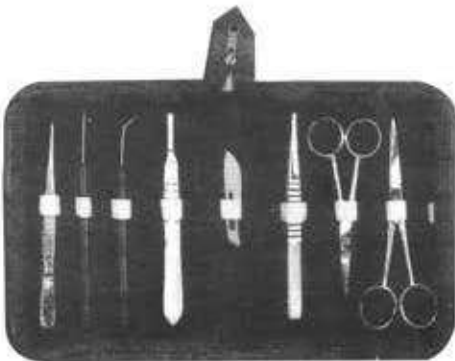

18-184

- 1- Dissecting Forcep 11.5 cm Sharp Point.
- 2- Iris Scissor
- 3- B.P Handle No. 4
- 4- Teasing Needle Sharp angular.
- 5- Blade No. 22
- 6- Thumb Forceps T.O.E 13 cm
- 7- Dissecting Scissor STR 11.5 cm
- 8- Dissecting Scissor STR 13 cm
- 9- Zipper case Inside Red Velvet



18-185

- 1- Grooved Director with Tongue Tie 14 cm
- 2- Probe Double 14cm
- 3- Mayo Hegar Needle Holder 14 cm
- 4- BP. Handle no.3
- 5- BP. Handle no.4
- 6- Dressing Scissor 14 cm S/B STR
- 7- Dressing Scissor 14 cm S/B CVD.
- 8- Dressing Forcep 1x2 Teeth 14 cm
- 9- Dressing Forcep Serrated 14 cm



18-186

- 1- Probe double 12.5 cm
- 2- Scalpel
- 3- B.P Handle No. 4
- 4- 6 PCS Blade 2 each no. 21, 22, 23
- 5- Dissecting Forcep 12.5 cm
- 6- Dissecting Forcep 11.5 cm sharp Point.
- 7- Dissecting Scissor S/B STR 13 cm
- 8- Dissecting Scissor S/S STR 13 cm



18-187

- 1- Teasing Needle with Chuck CVD.
- 2- Huber Probe
- 3- Iris Scissor
- 4- Dissecting Forcep Fine 14 cm.
- 5- Dissecting Forcep Fine CVD. 12 cm
- 6- Operating Scissor with Probe 14 cm.
- 7- B.P. Handle no. 4



18-188

- 1- Probe with eye
- 2- Dissecting Forcep cvd fine 12 cm.
- 3- Iris Scissor
- 4- Operating Scissor S/B str 14 cm
- 5- Grooved Director and Tongue tie
- 6- Huber Probe
- 7- Triple Chain Hook
- 8- B.P Handle No. 4
- 9- B.P Handle No. 3
- 10- Teasing Needle with Chuck cvd.
- 11- Teasing Needle with Chuck str.
- 12- Dissecting Forceps Fine 14 cm.

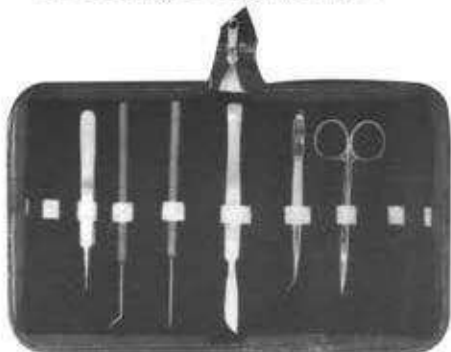

18-190

- 1- Iris Scissor STR
- 2- Dissecting Forceps CVD 12 cm.
- 3- Scalpel
- 4- Teasing Needle STR wooden handle.
- 5- Teasing Needle CVD wooden handle.
- 6- Watchmaker fine point.



18-192

- 1- Probe double end.
- 2- Grooved director and tounge tie.
- 3- B.P handle no.4
- 4- Operating scissor STR S/b14cm.
- 5- Kelly forceps STR 14cm.
- 6- Dissecting forceps thumb 13cm.

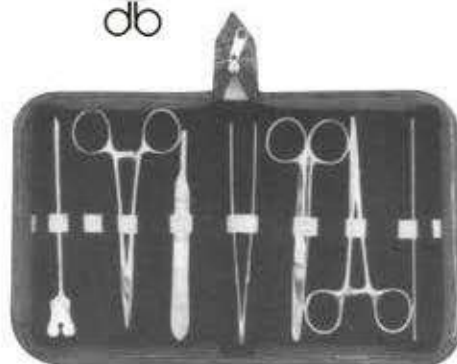

18-189

- 1- Grooved Director and Tongue tie
- 2- Mayo Hearg Needle Holder 14 cm
- 3- B.P Handle No. 4
- 4- Dissecting Forceps Thump 14 cm.
- 5- Operating Scissor S/B str 14 cm
- 6- Kelly Forcep STR 14 cm.
- 7- Probe Double end



18-191

- 1- Probe Double end
- 2- B.P Handle No. 4
- 3- Dissecting Forcep 1x2 Teeth 14 cm.
- 4- Operating Scissor S/B str 14 cm
- 5- Mayo Hearg Needle Holder 14 cm
- 6- Kelly Forcep STR 14 cm.
- 7- Operating Scissor S/B CVD 14 cm
- 8- Grooved Director and Tongue tie
- 9- Dissecting Forceps Thumb 14 cm.



18-193

- 1- Dissecting Forceps Thumb 14 cm
- 2- Dissecting Forcep 1x2 Teeth 14 cm.
- 3- B.P Handle No. 3
- 4- Grooved Director and Tongue tie
- 5- Mayo Hearg Needle Holder 14 cm
- 6- Operating Scissor S/B str 14 cm
- 7- Probe Double end
- 8- Kelly Forcep STR 14 cm.

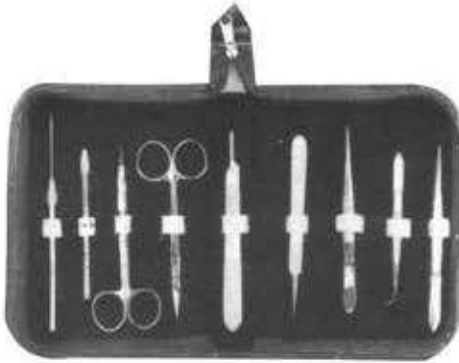

18-194

- 1- Dissecting Forcep Fine 14cm.
- 2- Dissecting Forcep Fine CVD 12cm
- 3- Dissecting Forcep with Pin 14cm.
- 4- Watchmaker Fine point
- 5- Iris scissor STR
- 6- Iris scissor CVD.
- 7- Teasing Needle holder
- 8- Teasing Needle STR.
- 9- B.P. Handle no. 3



18-195

- 1- Teasing Needle STR.
- 2- Grooved Director and Tongue Tie.
- 3- Teasing Needle CVD.
- 4- Dissecting Forcep with Pin 12 cm Fine
- 5- Operating Scissor S/B STR 14 cm
- 6- Triple Chain Hook
- 7- Probe with eye
- 8- Probe Double end
- 9- Probe and Hook
- 10- Dissecting Forcep Fine 14 cm
- 11- Iris Scissor
- 12- Huber Probe
- 13- B.P. Handle no.3
- 14- B.P. Handle no.4



18-196

- 1- Dissecting forcep fine STR with pin 12cm.
- 2- Iris scissor STR.
- 3- Probe with eye.
- 4- Probe and hook.
- 5- Operating scissor S/B STR 14cm
- 6- Triple chain hook.
- 7- B.P. handle no.4
- 8- Humber probe.
- 9- B.P.handle no.3
- 10- Teasing needle STR plastic handle.
- 11- Teasing needle CVD plastic handle.
- 12- Grooved director and tongue tie.
- 13- Probe double end.



18-197

- 1- Dissecting Forceps Thumb 14 cm.
- 2- Dissecting Forcep 1x2 Teeth 14 cm.
- 3- B.P Handle No. 3
- 4- Grooved Director and Tongue tie
- 5- Mayo Hearn Needle Holder 14 cm
- 6- Operating Scissor S/B str 14 cm
- 7- Probe Double end
- 7- Kelly Forcep STR 14 cm.



19-101 - 115
Schimmelbusch

	Ø x H sizes in mm
19-101	80 x 80
19-102	105 x 120
19-103	140 x 140
19-104	160 x 120
19-105	160 x 150
19-106	190 x 150
19-107	190 x 190
19-108	240 x 160
19-109	240 x 240
19-110	290 x 160
19-111	290 x 240
19-112	340 x 160
19-113	340 x 340
19-114	390 x 190
19-115	390 x 290



19-116
Box
120 x 65 x 13mm
(without Bulldog clamps,
without silicone tape)



19-117
Box with support
120 x 65 x 13 mm
(ohne Bulldogklemmen)



19-118
Box with support for
needle electrodes,
without instruments



19-119 - 121
50 x 25 x 4,5 mm
19-120
65 x 42 x 8 mm
19-121
75 x 25 x 4,5 mm



19-122
Ø 65mm x 15mm



19-123 - 131

	Ø x H
19-123	30 x 90 mm
19-124	50 x 100 mm
19-125	50 x 130 mm
19-126	50 x 175 mm
19-127	75 x 100 mm
19-128	75 x 130 mm
19-129	75 x 175 mm
19-130	100 x 175 mm
19-131	100 x 200 mm



19-141 - 142

- 19-141** Martin Sterilizing Forceps consisting of:
 1 Sterilizing Forceps, curved, 25 cm, without ratchet, with lid for jar
 1 jar with bottom plate (anti-tilt)
- 19-142** ditto, with 32 cm long Sterilizing Forceps



19-132 - 139

19-132	165 x 85 x 35 mm
19-133	200 x 100 x 35 mm
19-134	200 x 100 x 50 mm
19-135	230 x 130 x 50 mm
19-136	260 x 150 x 50 mm
19-137	270 x 235 x 50 mm
19-138	300 x 200 x 50 mm
19-139	325 x 275 x 50 mm



19-140
 205 x 105 x 35 mm



19-143 - 148

	Ø x H
19-143	75 x 60 mm
19-144	75 x 75 mm
19-145	100 x 60 mm
19-146	100 x 100 mm
19-146A	125 x 80 mm
19-147	125 x 125 mm
19-148	150 x 150 mm



19-149
25 cc

19-150
50 cc



19-151
20 cc
Medicine Spoon



19-152
Ø 75 x 12 mm
Tablet Tray



19-153
Ø 90 x 90 mm
Metal Cup



19-154
Ø 75 x 80 mm
Sputum Cup



Kidney Dish



19-155 - 157

19-155	170 x 100 x 35 mm
19-156	250 x 140 x 40 mm
19-157	275 x 150 x 45 mm



19-158 - 165



19-166 - 170

	Ø x H		
19-158	40 x 19 mm	0.05L	
19-159	61 x 30 mm	0.07L	
19-160	80 x 40 mm	0.14L	
19-161	116 x 50 mm	0.35L	
19-162	128 x 55 mm	0.45L	
19-163	147 x 65 mm	0.70L	
19-164	167 x 75 mm	1.10L	
19-165	187 x 85 mm	1.60L	

19-166	116 x 35 mm	0.30L
19-167	128 x 38 mm	0.40L
19-168	147 x 40 mm	0.50L
19-169	157 x 45 mm	0.75L
19-170	187 x 45 mm	1.00L



19-171
Ø 110 x 28 mm 0.15L



19-172
100 cc 0.1L



19-173 - 176
19-173 0.25L
19-174 0.50L
19-175 1.00L
19-176 2.00L



19-177
235 x 190 x 40 mm



19-178
Ø 220 x 70 mm



19-179
∅ 50 x 100 mm
Powder Pot



19-180
∅ 50 x 75 mm
Methot With Lid



19-181
∅ 50 x 75 mm
Methot Without Lid



19-182



19-183



19-184



19-185 - 186

19-185 ∅ 235 mm
19-186 ∅ 310 mm



19-187
Sauerbruch
210 x 125 x 17 mm



19-188
Sauerbruch
210 x 125 x 17 mm



19-189
150 x 95 x 13 mm



19-190
150 x 95 x 13 mm



19-191
150 x 95 x 13 mm



19-192
150 x 95 x 13 mm



19-193
150 x 95 x 13 mm



19-194
150 x 95 x 13 mm



19-195
150 x 95 x 11 mm



19-199 - 209

19-199	230 x 130 x 50	mm
19-200	260 x 150 x 50	mm
19-201	275 x 235 x 50	mm
19-202	300 x 200 x 50	mm
19-203	325 x 275 x 50	mm
19-204	420 x 175 x 50	mm
19-205	230 x 130 x 75	mm
19-206	260 x 150 x 75	mm
19-207	300 x 200 x 75	mm
19-208	325 x 275 x 75	mm
19-209	420 x 175 x 75	mm



19-196
Deponette
245 x 135 x 35mm



19-197
Deponette
245 x 135 x 50mm



19-198
Deponette
245 x 135 x 60mm



19-210 - 212

19-210	480 x 250 x 50	mm
19-211	520 x 250 x 75	mm
19-212	520 x 250 x 100	mm

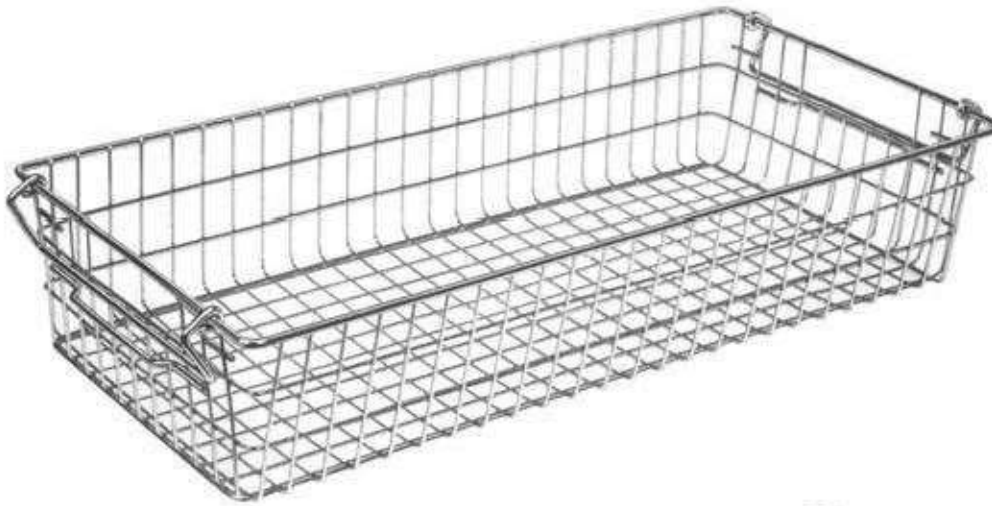

19-219
(60 x 30 x 15 cm)
Nominal dimensions



19-213 - 218

19-213	240 x 240 x 50	mm
19-214	240 x 240 x 80	mm
19-215	240 x 240 x 100	mm
19-216	480 x 260 x 50	mm
19-217	520 x 260 x 80	mm
19-218	520 x 260 x 100	mm



26-101
Standard

14,5cm
16,5cm
18,5cm



26-102
Standard

14,5cm
16,5cm
18,5cm



26-103
Standard

14,5cm
16,5cm
18,5cm



26-104
Standard

14,5cm
16,5cm
18,5cm



26-105
Standard

14,5cm
16,5cm
18,5cm



26-106
Standard

14,5cm
16,5cm
18,5cm

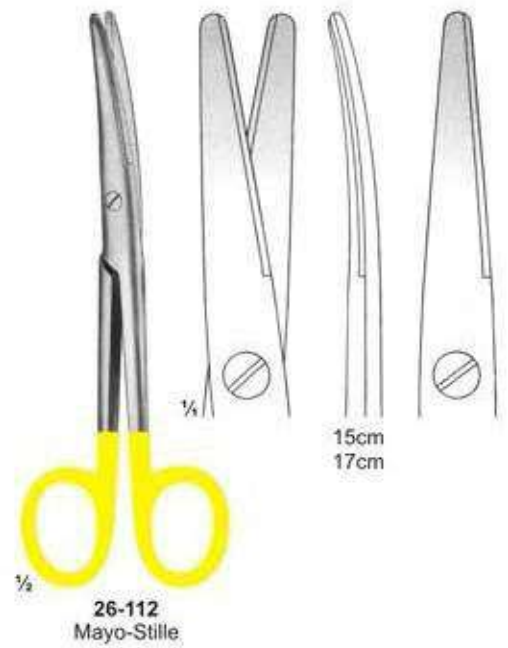
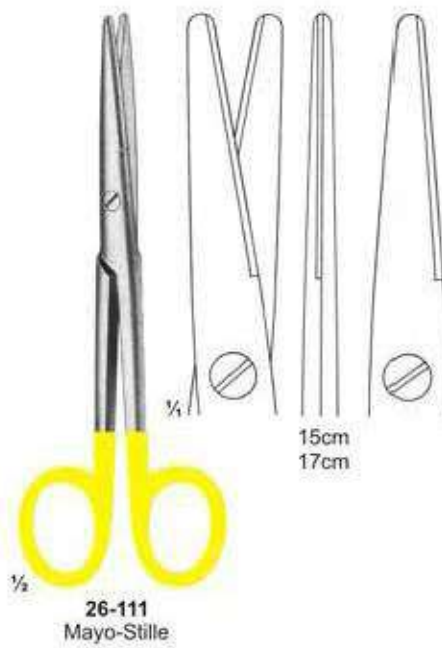
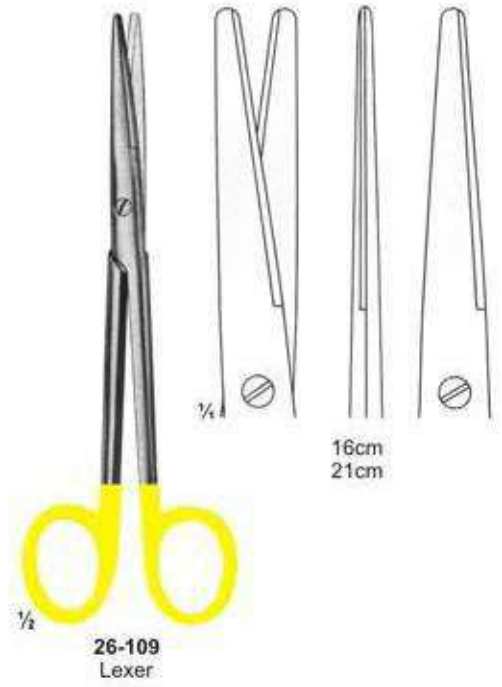
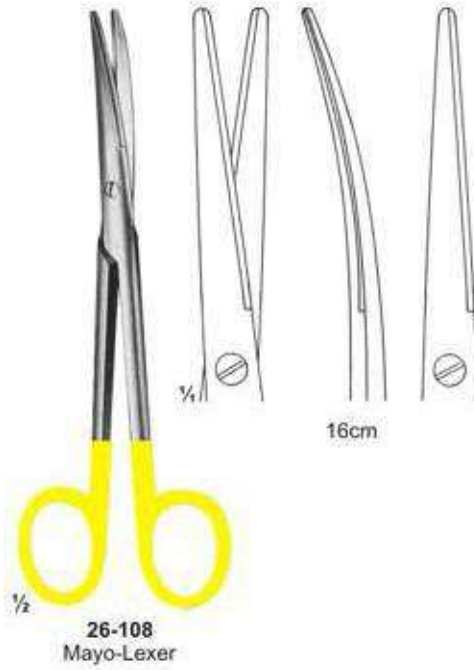



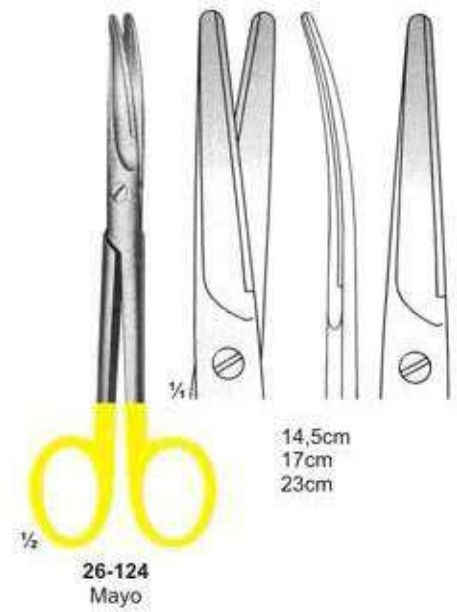
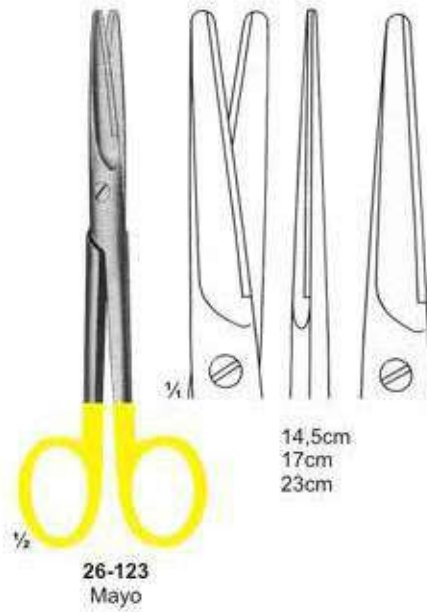
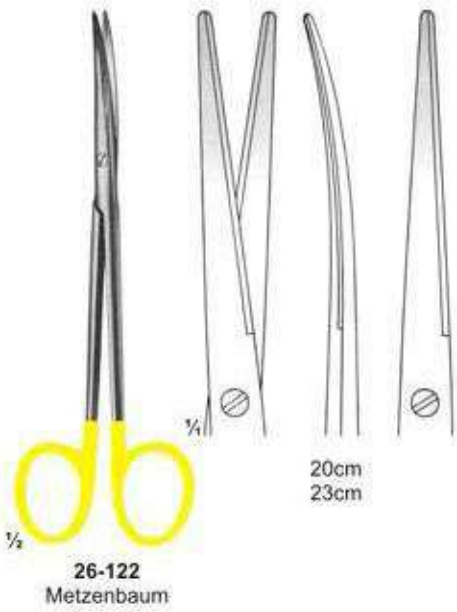
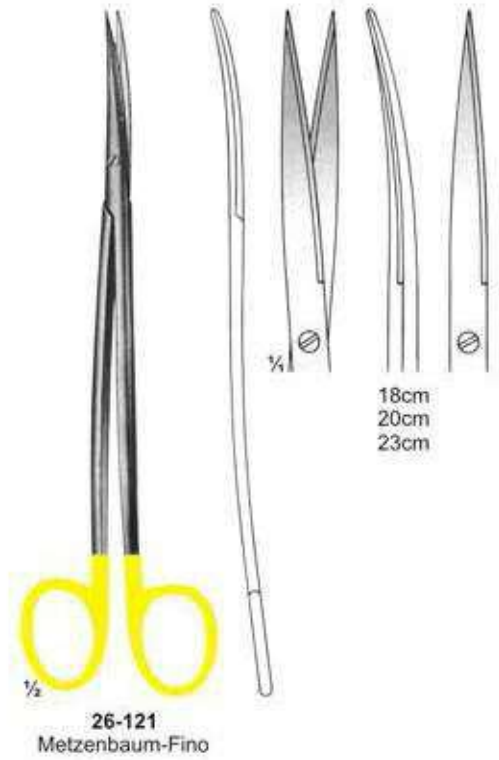
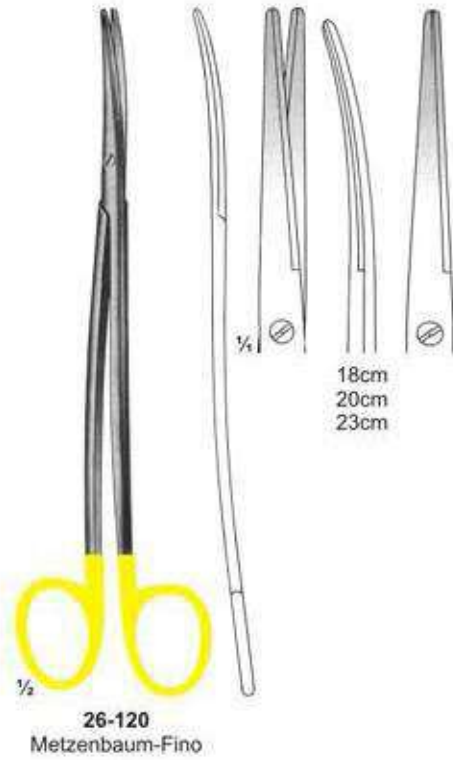

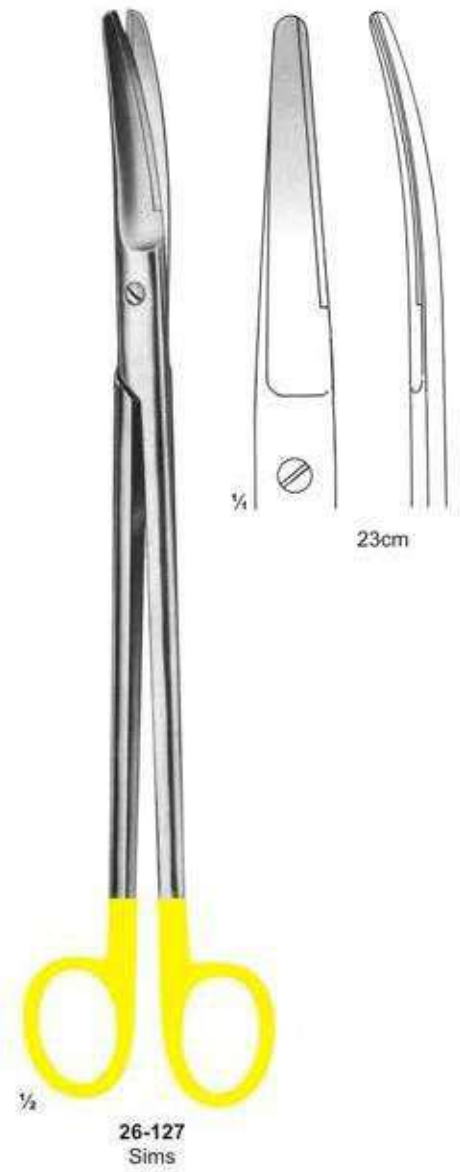
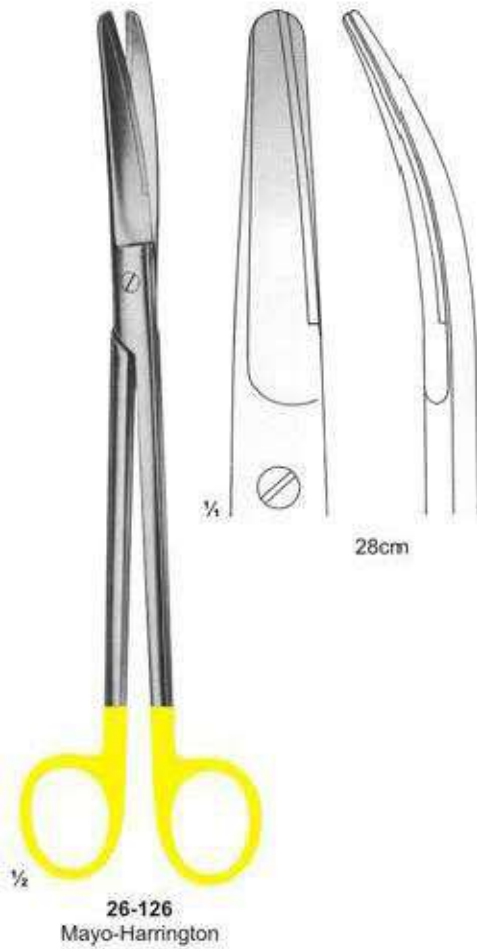
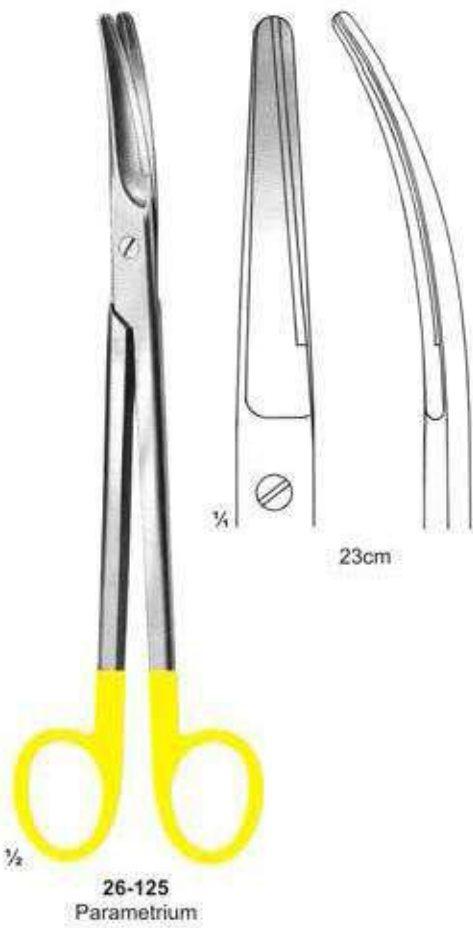

Scissors with Tungsten Carbide Inserts

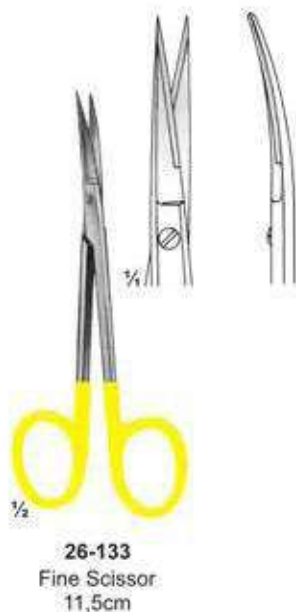
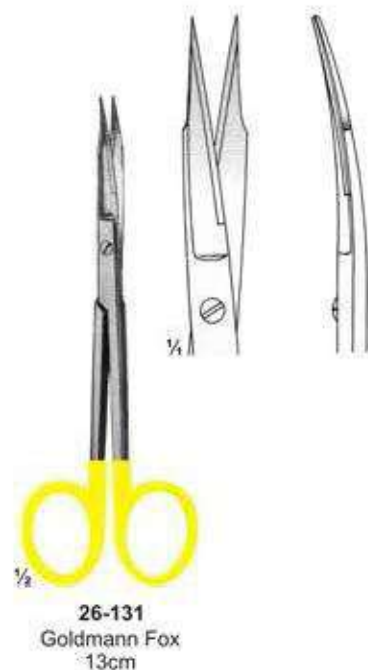

Scissors & Dissecting Forceps with Tungsten Carbide Inserts

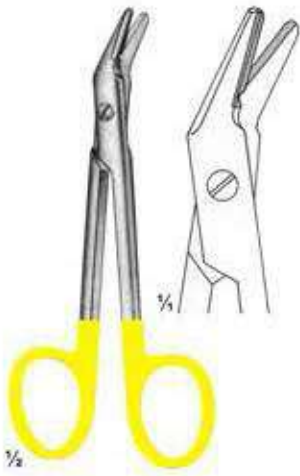

26-136
Universal
12cm



26-137
Ligature Scissors
1 Black & 1 Goldplated ring

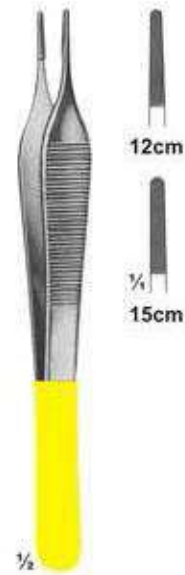

26-138
Adson



26-139
Cushing
17,5cm



26-140
Cushing
18cm



26-141
Cushing-Taylor
18cm



26-142
Dissecting Forceps
15cm



26-143
Semken
15cm

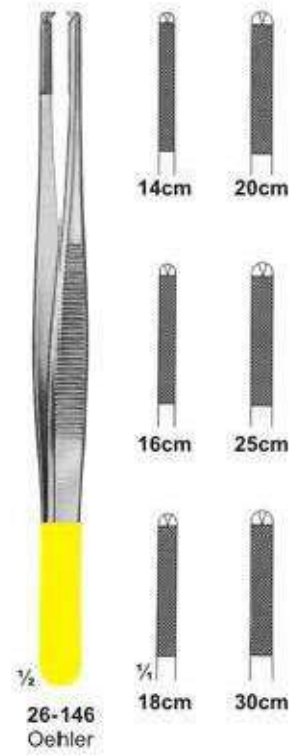
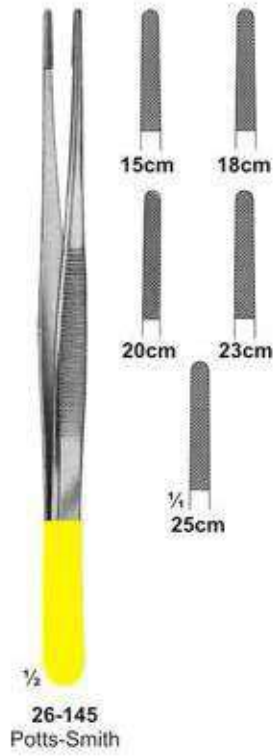

Needle holders with Tungsten Carbide Inserts



26-152
Arruga
16cm



26-153
Castroviejo
13cm



26-154
Hegar
20cm 24cm

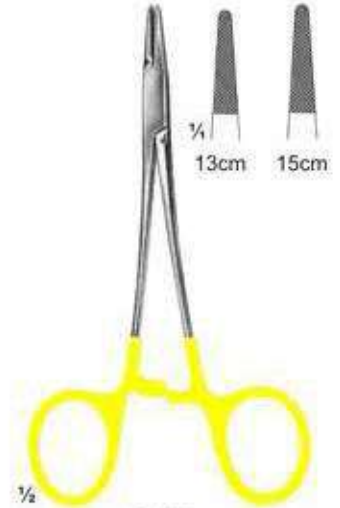

26-155
Halsey
13cm 15cm



26-156
Mayo-Hegar
16cm 18cm 20cm
24cm 26cm 30cm



26-157
De-Bakey
18cm 20cm 23cm
26cm 31cm 37cm



26-158
Hegar-Vascular
14cm 18cm
20cm 23cm

Needle holders with Tungsten Carbide Inserts



1/2
26-159
Bozemann-Wertheim
20cm 24cm 26cm



1/2
26-160
Stratte
22cm 23cm

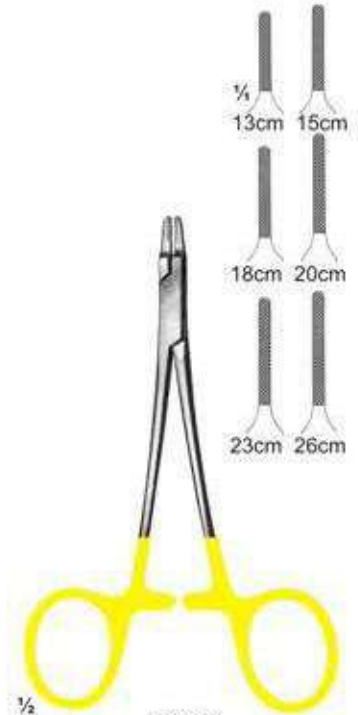

1/2
26-161
Ryder
13cm 15cm 18cm
20cm 23cm 26cm



1/2
26-162
Ryder-Vascular
13cm 15cm 18cm
20cm 23cm 26cm



1/2
26-163
Martin
15cm 17cm 20cm



1/2
26-164
Sarat
18cm 20cm 26cm

Needle holders with Tungsten Carbide Inserts

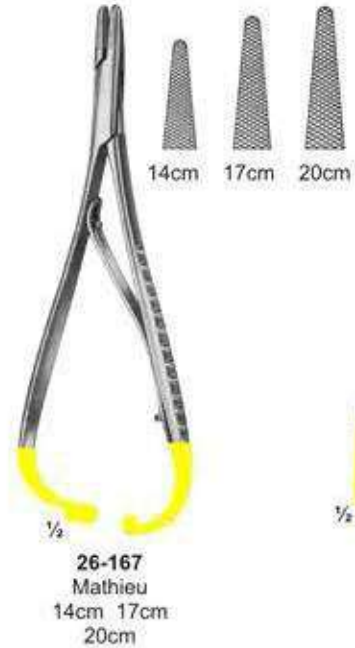

Needle holders with Tungsten Carbide Inserts



$\frac{1}{2}$
26-172
 Mathieu-Ryder
 17cm
 20cm 24cm



$\frac{1}{2}$
26-173
 Lichtenberg
 20cm



$\frac{1}{2}$
26-174
 Langhals
 20cm 25cm



$\frac{1}{2}$
26-175
 Lichtenberg
 20cm 25cm



$\frac{1}{2}$
26-176
 Luehty-Beck
 20cm 25cm



$\frac{1}{2}$
26-177
 Luehty-Beck
 20cm 25cm



$\frac{1}{2}$
26-178
 Langebeck
 18cm
 20cm 23cm



$\frac{1}{2}$
26-179
 Langebeck-beck
 18cm
 20cm 23cm



26-180
TOENNIS
 Elastic pattern for
 dura-or intestinal suture
 180 mm

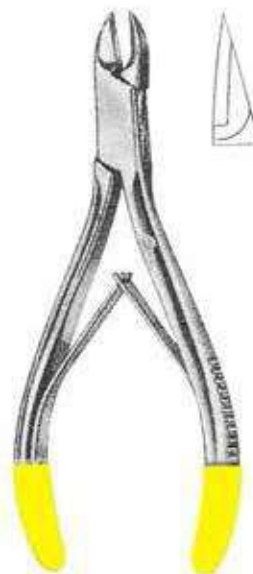

26-181
 Cutting Plier
 12 cm

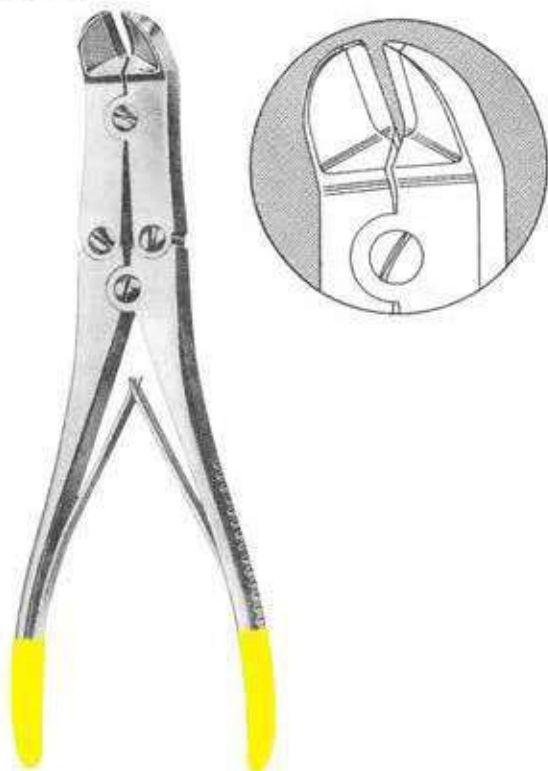

26-182
MULLAR CLAUS
 22 cm



26-183
 Plier
 17.5 cm

A	
ABRAHAM, tonsil knife	13
ADSON, forceps	33
ADSON, forceps	37
ALLIS, artery traction forceps	47
ALLIS, intestinal grasping forceps	86
ALY, aesthesiometer	01
AMPUTATING KNIVES	12
ANDREW, tongue depressor	04
ANESTOPHON, stethoscope	02
ARRUGA, forceps	37
ARRUGA, needle holder	61
ASCH, biopsy curettes	112
AUFRIEHT, rasps	138
AYRE, cone knife, 235mm	13
ADSON - BROWN, Tissue Forceps	39
ADSON, Haemostatic Forceps	52
ANGLE, Wire Cutters Cutting Scissors	151
B	
BABCOCK, intestinal grasping forceps	86
BABY-ALLIS, artery traction forceps	47
BACKHAUS, towel clamps	48
BACKHAUS-KOCHER, towel clamps	48
BAILEY, rib spreaders	128
BAKES, gall duct dilators	95
BALFOUR, abdominal retractors	85
BALFOUR-BABY, abdominal retractors	84
BANE-HARTMANN, bone rongeurs	144
BARTH, bone curettes	139
BABY-MOSQUITO, Haemostatic Forceps	51
BABY-ROUX, Retractors	73
BABY-SENN-MILLER, Retractors	73
BEEBE wire scissor	29
BEER, cilia forceps	42
BENGOLEA, delicate forceps	50
BERGER, biopsy forceps	115
BERLINER, percussion hammer	01
BENDING PLIERS, Wire Holding forceps	150
BERTILLON, Examination & Measuring Instruments	10
BIEMER, vein scissor	16
BISHOP-HARMON, forceps	37
BIEMER, Suction Instruments	158
BLAKE, gall stone forceps	96
BLUMENTHAL, bone rongeurs	144
BONNEY, tissue forceps	41
BOSE, tracheal hooks	119
BOWLES, stethoscope	02
BOYS-ALLIS, artery traction forceps	47
BOZEMANN, dressing forceps	108
BOYNTON, Needle Holders	47
BRAUN, artery traction forceps	107
BRAUN, uterine probes	28
BRAUN-STADLER episiotomy scissor	31
BRAUN-STADLER, bandage scissors	102
BRIESKY, vaginal specula	66
BRODIE, probes	34
BROPHY, dissecting forceps	04
BRUENINGS, tongue depressor	13
BRUNINGS, tonsil knife, 215mm	76
BRUNNER, retractors	126
BRUNNER, rib shears	31
BRUNS, plaster scissor	64
BRYANT, sponge forceps	43
BROPHY, Tissue Forceps	38
BROWN, Tissue Forceps	39
BUCHS, retractors	75
BUCHWALD, tongue depressor	04
BUCK, neurological hammer	01
BUMM, ovum forceps	230
BUCK, Ear Curettes	110
C	
CASPAR, retractor	75
CASPAR, Micro scissor 115mm	16
CASTROVIEJO, tissue forceps	37
CASTROVIEJO, micro spring scissor	15
CASTROVIEJO, needle holder	61
CASTROVIEJO, eye scissor 110mm	15
CASTROVIEJO, eye scissor 115mm	15
CATLIN, amputating knife 160mm	12
CALIPER, Examination & Measuring Instruments	10
CARREL, Haemostatic Forceps	51
CARROLL, Examination & Measuring Instruments	10
CASPAR, Rongeurs	133
CASPAR, Rongeurs	134
CASTROVIEJO, Examination & Measuring Instruments	10
CHAPUT, artery traction forceps	47
CLOWARD, lamina Spreaders	83
CLAUS PLIER, Wire Cutting Plier With T.C. Inserts	187
CLAUS PLIER, Wire Cutting Plier With T.C. Inserts	187
COAKLEY, antrum trocars	100
COLLIN, intestinal grasping forceps	86
COLLIN, rib shears	126
COLLIN, sponge and dressing forceps	44
COLLIN, tongue forceps	05
COLLIN, vaginal spatula	101
CONE KNIFE 235mm11	13
CONVERSE, fine wound retractor	69
COOLEY, multi purpose clamps	122
COTTLE, retractors	71
COTTLE, nasal scissor	25
COTTLE, fine wound retractor	69
COTTLE, mallets	140
COLLIN, Examination & Measuring Instruments	10
COLLIN, Intestinal Grasping Forceps	46
COLLIN, Retractors	73
COLLIN-HARTMANN, Retractors	73
COTTLE, Forceps, Bayonet - Shaped	40
COTTLE, Nasal Specula	91
CRILE, Haemostatic Forceps	52
CRILE, Haemostatic Forceps	52
CRILE, Retractors	73
CUTTING PLIER, Wire Cutting Plier With T.C. Inserts	187
CRAFOORD, haemostatic forceps	50
CRILE, needle holder	63
CUSCO, vaginal specula	101
CUSHING, wound and vein retractor	71
CUSHING, dissecting forceps	34
CUSHING-KOCHER, retractors	71
CZERNY, gall stone forceps	96
CZERNY, retractors	72

D		F	
DAVIDSON, scapula retractors	77	FARABEUF, Retractors	73
DAVIS, vascular spatulas	120	FEILCHENELD, splinter forceps	42
DANDY, Haemostatic Forceps	51	FERGUSSON, haemorrhoidal forceps	93
DE BAKEY, forceps	36	FERGUSSON, suction instrument	163
DE BAKEY, anastomosis clamps	89	FERGUSSON-ACKLAND, mouth gag	05
DE BAKEY, anastomosis clamps	125	FINOCHIETTO, forceps	58
DE BAKEY, arteriotomy scissor	22	FINOCHIETTO, rib spreader	127
DE BAKEY, vana cava clamps	123	FINSEN, tracheal hooks	119
DE BAKEY, multi purpose clamps	122	FIBER OPTIC, laryngoscopes	09
DE BAKEY, retractors	82	FINGER NAIL DRILL, Finger Nail Instruments	155
DE BAKEY, atraumata	121	FINGER RING SAW, Finger Nail Instruments	155
DEAN, nasal and tonsil scissor	25	FINSTERER, Suction Instruments	161
DEAVER, retractors	77	FLAT-NOSED PLIERS, Wire Holding forceps	150
DEAVER, surgical scissor (flat lock)	21	FOERSTER-BALLENGER, Tissue Grasping Forceps	45
DE-BAKEY, bulldog clamps	49	FORCEPS, Finger Nail Instruments	155
DEJERINE, percussion hammer	01	FOREGGER, laryngoscopes	09
DELICATE DISSECTING FORCEPS	33	FOMON, nasal scissor	19
DELICATE SCISSORS, blunt points	19	FORD-BOWLES, stethoscope	02
DELICATE SCISSORS, sharp points	18	FOWLER, tonsil knife	13
DELICATE SCISSORS, sharp points	19	FRANCKE, blood lancet	06
DENHARDT, mouth gag	05	FRAZIER, fine wound retractor	69
DENIS-BROWENE, intestinal forceps	41	FRAZIER, suction instruments	163
DERRA, multi purpose clamps	122	FREER, fine wound retractor	69
DESCHAMPS, ligature needles	65	FREER, vascular spatulas	120
DESJARDINS, gall duct forceps	95	FRENZEL, tongue depressor	04
DESJARDINS, gall stone forceps	96	FRICKE, haemostatic forceps	56
DESJARDINS, gall stone scoops	95	FRITSCH, retractor	79
DESMARRES, wound and vein retractors	71		
DEMEL, Cerclage Instruments	148	G	
DIAGNOSTIC SETS	07	GALLAHER, rasp	126
DICK, vaginal clamps and compression forceps	59	GELPI, special retractors	82
DIEFFEBACH, bulldog clamps	49	GELPI, vaginal retractors	105
DINGMANN, bone holding forceps	142	GERALD, dissecting forceps	34
DISSECTING KNIVES	11	GIERTZ-STILLE, rib shears	126
Dissection Instruments	164	GILL, tissue forceps	37
Dissection Instruments	165	GILL-HESS, tissue forceps	37
Dissection Instruments	166	GILLIES, fine wound retractor	69
DITTEL, metal bougies	80	GILLIES, needle holder	63
DOYEN, abdominal retractors	79	GLOVER, bulldog clamp	49
DOYEN, intestinal clamps	87	GLUCK, rib shears	126
DOYEN, ovum forceps	230	GOOD, tonsil scissors	25
DOYEN, probes	66	GORNEY, suction instruments	163
DOYEN, towel clamps	48	GOSSET, abdominal retractors	84
DOYEN, vaginal specula	104	GRAEFE, fine wound retractor	69
DUROGRIP, Wire Holding forceps	149	GRAVE, vaginal specula	102
DUROTIP, Cutting Pliers	152	GROSS, dressing forceps	43
DUROTIP, Cutting Pliers	153	GUEDEL-NEGUS, laryngoscope	08
DUROTIP, Wire Cutters Cutting Scissors	151	GUTHRIE, fine wound retractor	69
DUVAL-COLLIN, Intestinal Grasping Forceps	46	GUYON, kidney clamps	97
DUPLAY, sponge and dressing forceps	43	GERALD, Tissue Forceps	38
DUVAL, intestinal forceps	41	GILLIES, Tissue Forceps	38
		GOLDSMITH, Nasal Specula	91
E		GRAEFE, Tissue Forceps	39
EISELSBERD, needle holder	63	GRAEFE, Tissue Forceps	39
ELSCHING, forceps	37	GRUENWALD, Forceps, Bayonet - Shaped	40
ENGL.MOD, towel clamps	48		
EPPENDORF, biopsy forceps	115	H	
ESMARCH, cloth and plaster scissors	31	HALLE, vascular spatulas	120
EISELSBERG-MATHIEU, Needle Holders	64	HALSTED-MOSQUITO, haemostatic forceps	50
EXTRACTION PLIERS, Wire Holding forceps	150	HARTMANN, intestinal clamps	87

HARVEY, plate scissors	29	KELLY, tissue grasping forceps	44
HAJEK-KOFLER, Punches	130	KERN-LANE, bone holding forceps	143
HALSTED, Haemostatic Forceps	52	KERRISON-JACOBY, punches	129
HALSTED-MOSQUITO, Haemostatic Forceps	51	KERSTING, anastomosis forceps	89
HARTMANN, Ear Polypus Forceps	112	KELLY, Haemostatic Forceps	51
HARTMANN-HALLE, Nasal Specula	91	KERRISON, Punches	130
HARTMANN-HERZFELR, Ear Polypus Forceps	112	KILLIAN, bone shear	26
HARTMANN-HOFFMAR, Ear Polypus Forceps	112	KILLIAN, rectal spatula	90
HARTMANN-WULLSTEIN, Ear Polypus Forceps	112	KILNER, fine dissecting scissors	22
HARVEY, Wire Cutters Cutting Scissors	151	KILNER, fine wound retractor	69
HEANEY, needle holder	62	KILNER, dissecting scissor	22
HEGAR, needle holder	62	KILLIAN, Nasal Specula	90
HEGAR-OLSEN, needle holder	63	KIRSCHNER, Cutting Pliers	154
HEGER, uterine dilators	106	KIRSCHNER, Wire Extension	147
HEISS, haemostatic forceps	50	KOCHER, Haemostatic Forceps	52
HEISS, dressing forceps	58	KOCHER, Haemostatic Forceps	54
HEISTER, mouth gag	05	KOCHER-OCHSNER, Haemostatic Forceps	55
HENING, plaster spreader	157	KLIMA ROSEGGER, trocars	100
HERGET, biopsy forceps	113	KOCHER, retractor	71
HERTZLER, abdominal retractors	84	KOCHER, bladder retractors	99
HERTZLER, rib spreaders	127	KOCHER, bone retractor	74
HESS, tissue forceps	37	KOCHER, retractors	75
HEYMANN-KNIGHT, scissors	25	KOLLE, blood lancet	06
HEYWOOD-SMITH, ovum forceps	109	KONIG, elevators	135
HEYWOOD-SMITH, sponge holding forceps	44	KONIG, raspatories	137
HEYWOOD-SMITH, tongue forceps	05	KONISATION SMESSER, retractors	57
HOLLOW NEEDLE, Suction Instruments	159	KRAUSE, biopsy tip	115
HOUSE, Suction Instruments	161	KRISTELLER, vaginal specula	102
HUBER, biopsy forceps	115	KRISTELLER, vaginal specula	103
HUNT, tumor & vessel forceps	32	KRONECKER, suture instruments	65
HUNTER, splinter forceps	42	KRONLEIN, haemostatic forceps	56
		KUMMEL, intestinal spatula	80
I		L	
INGE, lamina spreaders	83	LABORDE, tracheal dilators	119
INTEROSSEOUS, cartilage knife	12	LAHEY, artery traction forceps	47
IVES-FANSLER, anoscopes	92	LAHEY, gall duct forceps	94
J		LANE TRETOWAN, bone levers	136
JACKSON BURROWS, retractors	82	LANE, bone holding forceps	143
JACOBSON, bone curettes	139	LANE, bone levers	136
JACOBSON, needle holder	61	LANE, tissue forceps	41
JAEGAR, fine wound retractor	69	LANE, towel clamps	48
JAMESON, dissecting scissor	22	LANGE-HOHMANN, bone levers	136
JAMESON, needle holder	62	LANGENBACK, bone levers	135
JANSEN, bone curettes	139	LANGENBECK, with triangle handle	70
JANSEN, bone rongeurs	144	LANGENBECK, flap knife	12
JOHNS-HOPKING, bulldog clamps	49	LARYNGEAL MIRRORS	06
JOLL (FRIEDMAN), retractors	82	LAWRENCE, ligature forceps	58
JOLL, vaginal retractors	105	LANDOLT, Suction Instruments	160
JONES, towel clamps	48	LANDOLT, Suction Instruments	161
JOSEPH, bone file	138	LANGENBECK, Ear Curettes	110
JOSEPH, dura and skin retractor	69	LEBSCHKE, rib shears	126
JOSEPH, raspatories	137	LEGUEU, bladder retractors	99
JUDD-MASSON, bladder retractors	99	LEKSELL-STILLE, bone rongeurs	145
JANSEN, FORCEPS, Bayonet - Shaped	40	LERICHE, intestinal spatula	80
K		LEWIS, bone file	138
KADER, intestinal spatula	80	LISTER, bandage scissor	30
KALT, needle holder	61	LISTER, cloth scissor	30
KELLY, ovum forceps	109	LISTER, sponge forceps	43
KELLY, anoscopes	92	LISTON, bone cutting forceps	146



LOCKHART-MUMMERY, probes	66	MULLER, dura and skin retractor	69
LOCKWOOD, Intestinal Grasping Forceps	46	MURPHY, head band	03
LUCAE, FORCEPS, Bayonet – Shaped	40	MUSEUX, tissue grasping forceps	47
LUER, Retractors	73	N	
LOCKLIN, delicate scissor	25	NASAL SCISSORS	25
LOPEZ-REINKE, suction instruments	163	NAUJOKS wire scissors	29
LOWER, gall duct forceps	94	NAIL SPLITTING, Finger Nail Instruments	155
LOWMAN, bone clamps	143	NEEDLE HOLDER, for micro surgery	48
LOWMAN-GERSTER, bone clamps	143	NEGUS, tonsil forceps	57
LOWMAN-HOGLUND, bone clamps	143	NELATON, probes	66
LUCAS, gouges	141	NELSON, lung dissecting forceps	41
LUER-KORTE, gall stone scoops	80	NISSEN, gall duct forceps	94
LURE, bone rongeurs	144	NOTO, ovum forceps	109
M		NOTO, sponge holding forceps	44
MAGILL, laryngoscope	07	NOVAK-SCHOECKAERT, biopsy curettes	111
MALTZ, rasps	138	NOYES, micro spring scissor	15
MANNERFELT, osteotomes	141	O	
MANNERFELT, retractors	70	OLIVECRONA, dura scissors	24
MARTIN, uterine probes	107	OLIVECRONA, trigeminal knife	13
MARTINI, bone curettes	139	OTOSCOPE SETS	07
MASING, retractors	71	OTOSCOPE, Diagnostic Sets	07
MASSON, needle holder	62	P	
MASSON-LUETHY, needle holder	62	PARTSCH, raspatories	137
MATHIEU, retractors	72	PARTSCH, gouges	141
MAYO, dissecting scissors	23	PARTSCH, raspatories	137
MAYO, uterine probes	107	PAYR, pylorus clamps	86
MAYO-HARRINGTON, dissecting scissors	23	PEAN, haemostatic forceps	57
MAYO-NOBLE, dissecting scissors	23	PEAN, haemostatic forceps	51
MAYO-STILLE, dissecting scissors	23	PEAN, kidney clamps	97
MARTIN, Nasal Specula	90	PEDERSON, vaginal specula	102
MATHIEU, Needle Holders	64	PEET, splinter forceps	42
MATHIEU-STILLE, Needle Holders	64	PELKMANN, uterine dressing forceps	108
MC INDOE, forceps	34	PERKINS, self retaining retractors	81
MC KENTY, raspatories	137	PIERCE, trocars	100
MEAD, mallets	140	PINARD, wooden stethoscope	02
MC INDOE, Tissue Forceps	38	PLESTER, retractors	81
MCINTOSH, laryngoscopes	09	PLESTER, suction instruments	163
MEDIUM, Dissecting Forceps	35	POOL, suction instruments	162
MICRO-HALSTED, Haemostatic Forceps	51	POTTS-SMITH, cardiovascular scissor	24
MILLIN, Needle Holders	64	PROBES	67
MICHEL, laryngeal mirrors	06	PARKER, Retractors	73
MICRO SCISSORS, laterally angled	17	PEAN, Haemostatic Forceps	52
MICRO-ADSON, forceps	33	PEAN, Haemostatic Forceps	53
MICRO-ADSON, forceps	37	PEAN, Haemostatic Forceps	54
MIDDELDORPF, retractors	75	PENNINGTON, Tissue Grasping Forceps	45
MIKULICZ, tissue forceps	57	PROVIDENCE-HOSPITAL, Haemostatic Forceps	51
MIKULICZ, intestinal spatula	80	Q	
MIKULICZ, retractors	78	QUERVAIN, bone levers	113
MILLER, laryngoscope	08	R	
MILLIN, bladder retractors	99	RABINER, neurological hammer	01
MIXTER, ligature forceps	58	RANDALL, biopsy curettes	111
MOD.USA, plaster spreader	127	RANDALL, kidney stone forceps	98
MORRIS, anastomosis clamps	89	RECAMIER, uterine scoops	116
MOYNIHAN, haemostatic forceps	57	REYNOLDS, dissecting scissors	22
MOYO-HEGAR, needle holder	62	RICHTER, vaginal retractors	105
MOD. WIEN, Nasal Specula	91	ROCHESTER-CARMALT, haemostatic forceps	57
MOLTGEN, Examination & Measuring Instruments	10	ROEDER, towel clamps	48
MULLAR, Wire Cutting Plier With T.C. Inserts	187		
MULLER LIGATURE FORCEPS	49		
MULLER VESSEL CLIPS	49		

ROUX, retractors	72
RUDD, haemorrhoidal ligator	93
RUMEL, dissecting forceps	58
RUSS-MODELL, tissue forceps	41
ROHRSCHNEIDER, needle holder	61
ROLLET, dura and skin retractor	69
ROSER KONIG, mouth gag	05
RAMPLEY, Tissue Grasping Forceps	45
RANKIN, Haemostatic Forceps	52
REILL, Cutting Pliers	152
REPLACEMENT LAMP, laryngoscopes	09
ROCHESTER-OCHSNER, Haemostatic Forceps	54
ROCHESTER-PEAN, Haemostatic Forceps	53
ROSE, Retractors	73
ROUND PLIERS, Wire Holding forceps	150

S

SAENGER, ovum forceps	118
SAMIL, tumor grasping forceps	32
SATINSKY, vena cava scissors	24
SAUPE, cilia forceps	42
SCALPEL HANDLES	14
SCHAAF, cilia forceps	42
SCHAEDEL, towel clamps	48
SCHEINMANN, biopsy forceps	115
SCHIMMELBUSCH, ether mask	05
SCHMID, vascular spatulas	120
SCHOEMAKER-LOTH, needle holder	63
SCHOENBORN, retractors	71
SCHRODER, uterine scoops	116
SCHUMACHER, rib shears	126
SCHUMACHER, umbilical scissors	28
SCHUMASHER, biopsy forceps	114
SCOVILLE-RICHTER, retractors	67
SEGOND, myomatome	13
SEIDL, vaginal specula	102
SEIDL-DBP, biopsy forceps	114
SELLORS, rib spreaders	128
SEMKEN, dissecting forceps	34
SEMKEN, tissue forceps	37
SENN-MILLER, Retractors	73
SEUTIN, plaster scissor	31
SHAPLEIGH, Ear Curettes	110
SIMON, uterine scoops	116
SIMPLEX, tongue depressor	04
SIMPSON, uterine probes	107
SIMPSON-BRAUN, obstetrics forceps	117
SIMS, gynaecology scissors	27
SIMS, vaginal specula	102
SIMS, rectal specula	90
SIMS, uterine probes	107
SMOOTH JAWS FORCEPS	34
ST.MARTIN, tissue forceps	37
STEMBERG, tongue depressor	04
STIEGLITZ, splinter forceps	42
STILLE, bone rongeurs	145
STILLE-AESULAP, plaster shears	156
STILLE-RUSKIN, bone rongeurs	145
STRACK, wire scissor	29
STRASSBURGER Tissue forceps	41
STANDARD, Dissecting Forceps	35
STANDARD, Tissue Forceps	39

STERBERG, Retractors	24
STRULLY, cardiovascular scissors (pointed)	24
SUCTION INSTRUMENTS	162
SURGICAL SCISSORS, incision	21
SURGICAL SCISSORS, serrated	20
SURGICAL SCISSORS, slender type	20
SURGICAL SCISSORS, standard	20
SURGICAL SCISSORS, standard	20
SUTURING INSTRUMENT SET	68
SYSTRUNK, nail splitting scissors	21
SPENCER-WELLS, Haemostatic Forceps	
SYSTRUNK, Finger Nail Instruments	

T

TAKAHASHI, rongeur	112
TAYLOR, percussion hammer	01
TAKAHASHI, Rongeurs	132
THOREK, cardiovascular scissors	24
THORPE, corneal forceps	33
TIECK-HALLE, Nasal Specula	90
TOENNIS, Wire Cutting Plier With T.C. Inserts	187
TOWNLEY, Examination & Measuring Instruments	10
TOBOLD, tongue depressors	04
TOENNIS ADSON, dissecting scissors	22
TOENNIS, dissecting scissors	22
TOENNIS, fine wound retractor	69
TOENNIS, vascular spatulas	120
TOENNIS, needle holder	63
TRELAT, raspatories	137
TRIGEMINAL KNIFE	13
TROCARS	100
TROEMNER, percussion hammer	01
TROUSSEAU, tracheal dilators	119
TROCAR, Suction Instruments	159
TROELTSCH, FORCEPS, Bayonet - Shaped	40
TUFFIER, rib spreaders	127
TUTTLE, lung dissecting forceps	41

U

UMBILICAL CORD SCISSORS	28
UNIVERSAL BANDAGE SCISSORS	30
UNIVERSAL TROCARS	100
US-ARMY, retractors	72

V

VANNAS, micro spring scissors	15
VERNIER, Examination & Measuring Instruments	10
WISE GRIP, Wire Holding forceps	150
VOLKMANN, bone curettes	139
VOLKMANN, bone retractors	74

W

WANGENSTEEN, needle holder	62
WARTENMERG, pinwheel	01
WAGNER, Rongeurs	134
WAUGH, Tissue Forceps	38
WEBER, anastomosis clamps	124
WECKER, eye scissors	15
WEIL-BLAKESLEY, rongeurs	112
WEITLANER, self retaining retractors	81
WERTHEIM, gynaecology scissors	27
WERTHEIM, clamps and forceps	59
WERTHEIM-CULLEN, vaginal clamps	60
WIEDER, tongue depressor	04
WEIL-BLAKESLEY, Rongeurs	132
WILLIGER, bone curettes	139
WILLIGER, elevators	135
WILLIGER, raspatories	137
WINTER, ovum forceps	118
WILDE, Forceps, Bayonet – Shaped	40
WOLFF, plaster breakers	157
WULLSTEIN, retractors	81
WULLSTEIN, Suction Instruments	160

Y

YASARGIL, needle holder	61
YASARGIL, tumor grasping forceps	32
YASARGIL-SAMII, tumor grasping forceps	32
YASARGIL, Suction Instruments	160
YASARGIL, Suction Instruments	161
YASRGIL, micro scissors	17
YEOMAN, biopsy forceps	113
YOUNG, tongue forceps	05
YOUNG- HRYNTSCHAK, Needle Holders	64
YOUNG-MILLIN, Needle Holders	64

Z

ZENKER, ligature	58
ZENKER, retractors	77
ZIEGLER, head band	03
ZIEGLER, head mirror	03